

MATERIALS
MANUAL
OF
TEST
PROCEDURES

Effective January 23, 2020 Letting



**CURRENT DATE OF REVISION
MT 100 SECTION
CONCRETE**

Test Method No.	Title	Pages	Date of Publication or Revision
MT 100	Contractor Submitted Concrete Mix Design	3 pp	Dec 2017
MT 101	Making and Curing Concrete Compressive and Flexural Strength Test Specimens in the Field	1 pp	Dec 2015
MT 102	Eliminated (Use AASHTO T 152 Air Content of Freshly Mixed Concrete by the Pressure Method)		
MT 103	Measuring the Thickness of In-Place Concrete by Use of Concrete Thickness Gauge.....	3 pp	Mar 2007
MT 104	Eliminated (Use AASHTO T 119 Slump of Hydraulic Cement Concrete)		
MT 105	Eliminated (Use AASHTO R 60 Sampling Freshly Mixed Concrete)		
MT 106	Eliminated (Use AASHTO T 148 Measuring Length of Drilled Concrete Cores)		
MT 107	Eliminated (Use AASHTO T 196 Air Content of Freshly Mixed Concrete by the Volumetric Method)		
MT 108	Sampling and Certification of Portland Cement	2 pp	Jun 2004
MT 109	Method for Sampling Water	1 pp	Jun 2004
MT 110	Reinforced Concrete Pipe and Other Precast Items	4 pp	Jan 2012
MT 111	Sampling, Inspection and Reporting on Prestressed Structural Members....	3 pp	Jan 2012
MT 112	Eliminated (Use AASHTO T 24 Obtaining and Testing Drilled Cores and Sawed Beams of Concrete)		
MT 113	Eliminated (Use ASTM E965 Measuring Pavement Macrotexture Depth Using a Volumetric Technique)		
MT 114	Sampling for Chloride Content of Bridge Deck Concrete	3 pp	Feb 2010
MT 115	Eliminated (Use AASHTO T 121 Density (Unit Weight), Yield, and Air Content (Gravimetric) of Concrete)		
MT 116	Eliminated (Use AASHTO T 347 Slump Flow of Self-Consolidating Concrete (SCC))		
MT 117	Making and Curing Concrete Compressive and Flexural Strength Test Specimens in the Field for Self-Consolidating Concrete (SCC).....	1 pp	Jun 2017
MT 118	Eliminated (Use AASHTO T 152 Air Content of Freshly Mixed Concrete by the Pressure Method)		
MT 119	Moisture Correction for Concrete Mix Designs (formerly MT 506).....	1 pp	Jun 2004
MT 120	Vacant		
MT 121	Effect of Organic Impurities in Fine Aggregate on Strength of Mortar	1 pp	Jun 2016
MT 122	Optimized Aggregate Gradation for Hydraulic Cement Concrete Mix Designs (formerly MT 215).....	6 pp	Jan 2017

METHODS OF SAMPLING AND TESTING
MT 100-17
CONTRACTOR SUBMITTED CONCRETE MIX DESIGN

1 Scope

- 1.1 This document describes required mix design procedures for independent concrete mix designs and establishes the information required for a mix design submittal.
- 1.2 This procedure applies to the Montana Department of Transportation (MDT) projects requiring an approved concrete mix design. It is to be used for preparation of a mix design by the contractor for submission to MDT's Materials Bureau for final approval.
- 1.3 It is the responsibility of the contractor to provide mix designs meeting the required specifications of Section 551, plans, supplemental requirements, and any special provisions included in the contract. The testing of the contractor's proposed mix design must be performed by a certified laboratory or performed by a certified technician with a Professional Engineer as the signature of record. A certified laboratory is any laboratory meeting the requirements of ASTM C1077. A certified technician will have current ACI Field, Laboratory and Strength Testing certifications or corresponding current WAQTC certifications. Perform concrete mix designs in conformance with Montana, AASHTO, ACI and ASTM procedures. Mix Designs submitted by Certified Precast or Prestressed concrete plants are exempt from this subsection. A Certified plant is any concrete plant listed on the MDT's Qualified Products List (QPL).

2 Referenced Documents***ASTM***

C1077 Standard Practice for Agencies Testing Concrete and Concrete Aggregates for Use in Construction and Criteria for Testing Agency Evaluation

MT Materials Manual

MT 601 Materials Sampling, Testing, and Acceptance Guide Index

3 Procedure

- 3.1 A mix design must be submitted for each class of concrete to be used on an MDT project to the Project Manager. Mix designs, including all required information, must be submitted 15 working days prior to concrete placement. Mix designs are to be submitted as either a new mix design or a mix design transfer.
- 3.2 *Materials:* All materials proposed are subject to approval. Refer to [MT 601](#) for sampling and testing requirements.
- 3.3 *New Mix Design (Trial Batches):* When submitting a new mix design, trial batches must be performed. Batches must be based on the same materials and proportions proposed for the project. Trial batches must be completed 15 working days before concrete placement. The Materials Bureau will review all documentation and accept or reject the mix design.

Create at least one trial batch for each concrete mix design. Simulate haul time and mixing conditions to ensure proper workability at the jobsite. It is also recommended that a larger, more representative trial batch be made in the same manner as intended for project placement. For each trial batch, test in accordance with Annex A.1. All mix designs must include aggregate properties testing information for each aggregate size in accordance with Annex A.2. For alternative mix designs, per contract specifications, test in accordance with Annex A.3. Include data sheets for cementitious materials and admixtures with the design submittal. The trial batch will be subject to rejection if any test results fail to meet specified ranges and a new trial batch will

be requested. For each trial batch, cast a minimum of three sets of three test cylinders in 4" x 8" molds. Test and average one set at 3 days, one set at 7 days, and one set at 28 days. If earlier strength information is needed for de-tensioning prestressed applications, post tensioning, form removal, etc., submit strength data for the anticipated work. The average of the cylinders at 28 days must meet the minimum strength requirements of the contract. When permeability testing is required, perform testing of three cylinders cast from the trial batch in accordance with either AASHTO T 277 or AASHTO T 358. Cylinders used for AASTHO T 358 testing may be subsequently used for compressive strength determination. Based on the anticipated application of the mix design, cast and test as many specimens as needed to supply sufficient information.

- 3.4 *Mix Design Transfer:* Concrete mix designs used on MDT projects are valid for three years, provided they are transferred within 12 months of their previous use. Any request for transfer after three years will require new trial batches and resubmittal of the mix design. The contractor may request, in writing, the transfer of a concrete mix design to another project. There will be no substitutions of any materials or changes in mix proportions under this method. The Department may deny the transfer for any reason including, but not limited to, past performance, failing materials test results, raw material property changes, etc.

4 Acceptance

- 4.1 *Approval:* A representative of the MDT's Materials Bureau will verify and sign off approval of the new or transferred concrete mix design provided required information, test results, and proper forms are submitted, and all required MDT specifications are met. When a signed copy of approval is issued to the contractor, concrete placement may begin. Any time before or after approval of the design, the Material's Bureau may request additional materials for testing. Throughout the project, MDT may request additional tests be performed by the contractor to ensure proper placement and satisfactory test results.
- 4.2 *Rejection:* If a mix design produces failing results, a new mix design must be submitted for approval. The Materials Bureau may reject any design on the basis of any one failing test result.
- 4.3 In no case will the approval of a concrete mix design relieve the contractor of producing material meeting the contract requirements. Any changes or modifications to a mix design needed in the field must be approved by the Project Manager. A halt in production may be required for additional testing. Review and approval of the concrete mix design by a representative of the MDT's Materials Bureau does not constitute acceptance of the concrete. Acceptance of concrete will be based solely on the test results of concrete placed on the project.

ANNEX

- A.1** The following tests are required for all concrete mix design submittals:
- AASHTO R 39 Making and Curing Concrete Test Specimens in the Laboratory
 - AASHTO R 60 Sampling Fresh Concrete
 - AASHTO T 22 Compressive Strength of Cylindrical Concrete Specimens
 - AASHTO T 119 Slump of Hydraulic Cement Concrete
 - AASHTO T 121 Density (Unit Weight), Yield, and Air Content (Gravimetric) of Concrete
 - AASHTO T 152 Air Content of Freshly Mixed Concrete by the Pressure Method
 - AASHTO T 347 Slump Flow of Self-Consolidating Concrete (if applicable)
 - AASHTO T 345 Passing Ability of Self-Consolidating Concrete by J-Ring (if applicable)
 - AASHTO T 351 Visual Stability Index of Self-Consolidating Concrete (if applicable)
 - ASTM C1064 Temperature of Freshly Mixed Hydraulic Cement Concrete
 - MT 101 Making and Curing Concrete Test Specimens in the Field
- A.2** The following tests are required for aggregates for all concrete mix design submittals:
- AASHTO R 90 Sampling Aggregate Products
 - AASHTO T 11 Materials Finer Than 75- μm (No. 200) Sieve in Mineral Aggregates by Washing
 - AASHTO T 21 Organic Impurities in Fine Aggregates for Concrete
 - AASHTO T 27 Sieve Analysis of Fine and Coarse Aggregates (Including Fineness Modulus)
 - AASHTO T 84 Specific Gravity and Absorption of Fine Aggregate
 - AASHTO T 85 Specific Gravity and Absorption of Coarse Aggregate
 - AASHTO T 96 Resistance to Degradation of Small-Size Coarse Aggregate by Abrasion and Impact in the Los Angeles Machine
 - AASHTO T 104 Soundness of Aggregate by Use of Sodium Sulfate or Magnesium Sulfate
 - AASHTO T 112 Clay Lumps and Friable Particles in Aggregate
 - AASHTO T113 Lightweight Pieces in Aggregate
 - MT 121 Effect of Organic Impurities in Fine Aggregate on Strength Of Mortar*
- *As required per Specification 701.01.1(D)
- A.3** The following tests are required for alternative mix designs and for specific classes of concrete:
- AASHTO T 277 Electrical Indication of Concrete's Ability to Resist Chloride Ion Penetration
 - ASHTO T 358 Surface Resistivity Indication of Concrete's Ability to Resist Chloride Ion Penetration
 - ASTM C157 Standard Test Method for Length Change of Hardened Hydraulic-Cement Mortar and Concrete
 - ASTM C512 Standard Test Method for Creep of Concrete in Compression
 - ASTM C469 Standard Test Method for Static Modulus of Elasticity and Poisson's Ratio of Concrete in Compression
 - ASTM C457 Standard Test Method for Microscopical Determination of Parameters of the Air-Void System in Hardened Concrete

METHODS OF SAMPLING AND TESTING
MT 101-15
MAKING AND CURING CONCRETE COMPRESSIVE AND
FLEXURAL STRENGTH TEST SPECIMENS IN THE FIELD
(Modified AASHTO T 23)

MT 101 is identical to AASHTO T 23 except for the following stipulations:

1. Include the following Montana Materials Manual references.

MT Materials Manual

[MT 609 Field Numbering Concrete Cylinders](#)

2. Replace the 1st sentence in Section 10.1.3.1 with the following:

Cylinders – Upon receipt in the Materials Bureau, store specimens in a moist condition with free water maintained on their surfaces at all times at a temperature of $73 \pm 3^{\circ}\text{F}$ ($23 \pm 2^{\circ}\text{C}$) using water storage tanks or moist rooms complying with the requirements of AASHTO M 201, except when capping with sulfur mortar compound and immediately before testing.

3. Replace Section 11.1 with the following:

Prior to transporting, cure and protect specimens as required in Section 10. Specimens shall not be transported until at least 8 h after final set. For transporting, efforts shall be made to protect the specimens from jarring, extreme changes in temperature, freezing, and moisture loss. Before transporting specimens from the field to the laboratory for testing, place specimens in sturdy boxes surrounded by a suitable cushioning material to prevent damage from jarring. During cold weather, protect the specimens from freezing with suitable insulation material. Prevent moisture loss during transportation by wrapping the specimens in plastic or wet burlap and by surrounding them with wet sand or sawdust or using tight-fitting plastic caps for plastic molds.

METHODS OF SAMPLING AND TESTING
MT 103-07
METHOD FOR MEASURING THE THICKNESS OF IN-PLACE CONCRETE
BY USE OF CONCRETE THICKNESS GAUGE
(Montana Method)

1 Scope

- 1.1 This method covers the procedure for measuring the thickness of concrete pavements. Thickness is determined by using a concrete thickness gauge to measure the time required for an echo to bounce off the backside of the concrete member being tested. The thickness is a product of the velocity of sound in the material and one half the transit time (round trip) through the material.

2 Referenced Documents

AASHTO

T 148 Measuring Length of Drilled Concrete Cores

MT Materials Manual

MT 606 Selecting Sampling Locations by Random Sampling Technique

3 Apparatus

- 3.1 *Standard Surveying Equipment* – EDM, mirrors, level, rod, etc.
- 3.2 *Concrete Thickness Gauge*
- 3.3 *Core Drill* – for obtaining cylindrical core specimens
- 3.4 *Measuring Tape*

4 Vertical Control

- 4.1 When possible, it is recommended that at least one vertical control point be established for each day's placement of concrete, using survey methods prior to placement. After the concrete has hardened sufficiently, remeasure the same control point to determine the depth of the finished concrete. Use this point as a calibration point for the concrete thickness gauge. (Pre-established reference points and grade control points may also be used to determine concrete thickness).

5 Gauge Calibration Methods

5.1 Gauge Calibration

Place the concrete thickness gauge on the concrete, at the pre-established vertical control point, and calibrate according to the manufacturers instructions. The gauge will now establish the velocity for the particular concrete being tested.

5.2 Direct Input Method

Following the manufacturer's instructions, a direct input method may be used to calibrate the concrete thickness gauge. For the purpose of this method, a core will be taken to determine the actual thickness of the placed concrete. The concrete thickness gauge will then be calibrated using the core thickness.

6 Procedure

- 6.1 Calibrate the gauge according to one of the procedures described above. **The gauge must be calibrated on the concrete to be tested or the correct velocity entered into the gauge.** The calibration should be done on a smooth, clean surface to obtain the best data possible. (See Note 1) This data will be used for all subsequent tests and all tests must be completed on the same day as the gauge calibration.
- 6.2 Randomly select test locations (see Note 1) according to [MT 606 Random Sampling Technique](#) or as directed by the Engineering Project manager.
- 6.3 At the test location, take four measurements by rotating the gauge around a center point, collecting readings every 90 degrees. Average the results.

Note 1 – Make certain that the test head of the concrete thickness gauge is in good contact with the concrete surface. Testing should be done on a smooth clean surface to obtain the best data possible.

7 Calculation

- 7.1 Record gauge readings to the hundredth of a foot or (mm) on lab form
- 7.2 Record the average of the four (4) readings from each test location to a hundredth of a foot or (mm).
- 7.3 Determine and record the concrete thickness variation by subtracting the average of the four readings from the design thickness and record to the nearest hundredth of a foot (mm).

8 Report

- 8.1 Project Number
Project Name
Name of Tester
Title
Address
Date Measurements made
Test Location/Station
Test results

METHODS OF SAMPLING AND TESTING
MT 108-04
SAMPLING AND CERTIFICATION OF PORTLAND CEMENT

1 Scope

1.1 This method covers the requirements for sampling and certification of Portland cement.

2 General

2.1 Cement samples shall weigh a minimum of 6.8 Kg (15 pounds). Such samples shall be placed in air-tight plastic bags which shall in turn be placed in canvas bags to protect against breakage during shipment. The bin or silo number and the grind number shall be shown on the Lab. Form No. 55 to accompany the sample.

3 Procedure

3.1 A sample of cement shall be submitted to the Materials Bureau, prior to construction, for all projects which involve bridge construction or projects which involve 114.3 cubic meters (125 cubic yards) of concrete. The sample may be taken from existing stock at the ready mix plant. On many projects this will be the only sample required unless the provisions of Section 4 make additional sampling necessary.

4 Sampling Frequency

4.1 *Project Sampling*

4.1.1 Bridge Projects

4.1.1.1 Minimum of one sample taken prior to the start of concrete production.

4.1.1.2 One sample for each additional 458.6 cubic meters (600 cubic yards) of concrete used.

4.1.1.3 This procedure shall be used regardless of the number of structures involved in the project.

4.1.2 Paving Projects

4.1.2.1 One sample taken prior to the start of concrete production.

4.1.2.2 Additional samples taken for each 4572.0 cubic meters (5,000 cubic yards) of concrete produced.

4.1.3 Cement Treated Base Projects

4.1.3.1 One sample taken at the start of the project.

4.1.4 Miscellaneous Projects (cattle guards, sign bases, etc.)

4.1.4.1 One sample taken prior to the start of concrete production on jobs involving 114.3 cubic meters (125 cubic yards) of concrete or more.

4.1.4.2 Samples need not be submitted for projects involving less than 114.3 cubic meters (125 cubic yards) of concrete.

4.2 *Random Sampling*

- 4.2.1 Each district shall, in addition to samples taken in accordance with Section 4.1 above, submit a random sample of each brand of cement used in that district during the year. These samples may be taken at any time during the year.

5 Cement Certification

- 5.1 The cement plants shall furnish the Materials Bureau with certified test results for each new grind or bin of cement produced for use within the state.
- 5.2 Each shipment of cement from the manufacturing plant to a highway project shall be accompanied by a certificate of compliance. This certificate shall state that the cement complies with all the requirements of AASHTO M 85 or ASTM C150, low alkali cement, and shall be signed by a responsible representative of the cement plant. Two copies of this certification shall accompany the shipment, one for the consignee and one for the Engineering Project Manager.

METHODS OF SAMPLING AND TESTING
MT 109-04
METHOD OF SAMPLING WATER

1 Scope

- 1.1 This method covers the sampling of water for determination of its suitability for use in concrete, for determination of corrosivity, and for chemical testing for potability. It does not include sampling for biological testing.

2 Referenced Documents***MT Materials Manual***

MT 601 Materials Sampling, Testing, and Acceptance Guide Index

3 Application

- 3.1 This method is applicable to sampling industrial and domestic water supplies from sources such as wells, rivers, streams, lakes, ponds, reservoirs, pipelines and conduits for chemical or physical tests.

4 Point of Sampling

- 4.1 Where the water in a stream is mixed so as to approach uniformity, a sample taken at any point in the cross section is satisfactory.
- 4.2 For bodies of water such as ponds or reservoirs, avoid surface and/or bottom sampling and attempt to obtain an integrated sample containing water from all points in a vertical section. Depending upon the nature of the source being sampled, it may be desirable to sample at several points and to combine the samples to obtain a representative sample of the source.
- 4.3 In sampling from pipelines, conduits, pump discharge, etc., make certain that all conduits have been flushed. In the case of water wells, initial pumping for well cleaning purposes shall have been completed so the sample represents the sustained output of the source.

5 Frequency of Sampling

- 5.1 A sample of the water proposed for use shall be submitted in accordance with the frequency specified in MT 601.

6 Volume of Sample and Type of Container

- 6.1 Furnish a one liter (quart) sample in a clean glass or plastic bottle or jar with a screw cap lid with liner. Fill almost to the top, but allow a small space to allow for possible expansion due to temperature change.

7 Labeling

- 7.1 Label with identifying source data and state the purpose for which the sample is taken.

METHODS OF SAMPLING AND TESTING
MT 110-12
METHOD OF ACCEPTANCE FOR
REINFORCED CONCRETE PIPE AND OTHER PRECAST ITEMS
(Montana Test Method)

1 Scope

- 1.1 This procedure defines inspection responsibilities and verification processes applicable to all suppliers of pre-cast concrete pipe and associated items.

2 Referenced Documents**AASHTO**

- M 55 Steel, Welded Wire Reinforcement, Plain, for Concrete
M 85 Portland Cement
M 170 Reinforced Concrete Culvert, Storm Drain, and Sewer Pipe
M 206 Reinforced Arch Concrete Culvert, Storm Drain, and Sewer Pipe
M 207 Reinforced Elliptical Concrete Culvert, Storm Drain, and Sewer Pipe
M 259 Precast Reinforced Concrete Box Sections for Culvert, Storm Drains, and Sewers
T 24 Obtaining and Testing Drilled Cores and Sawed Beams of Concrete
T 119 Slump of Hydraulic Cement Concrete
T 152 Air Content of Freshly Mixed Concrete by the Pressure Method
T 347 Slump Flow of Self-Consolidating Concrete

ASTM

- C361 Standard Specification for Reinforced Concrete Low-Head Pressure Pipe

MT Materials Manual

- MT 101 Making and Curing Compressive and Flexural Strength Test Specimens in the Field
MT 108 Sampling and Certification of Portland Cement
MT 117 Making and Curing Concrete Compressive and Flexural Strength Specimens in the Field for Self-Consolidating Concrete (SCC)
MT 118 Method of Determining Air Content of Freshly Mixed Self Consolidating Concrete by the Pressure Method

MDT Construction Bureau

Manual for Culvert and Pipe Installation and Inspection

3 Definitions

ACPA – American Concrete Pipe Association
NPCA – National Precast Concrete Association

4 Inspection Process for ACPA and NPCA Certified Plants

- 4.1 Each participating manufacturer must maintain sufficient procedures and documentation to assure that their products are manufactured and tested in accordance with the guidelines of ACPA and/or NPCA certification programs. An MDT Inspector will conduct a thorough inspection of each Certified Plant to verify compliance with these requirements. Plants meeting these requirements will be listed on the Qualified Products List.

4.1.1 Yearly

Inspection Checklist

- Verify ACPA and/or NPCA certification.
- Verify that certified manufacturing plants have a Quality Control Manual, applicable AASHTO, ASTM standards, organizational chart, and personnel training and qualification records.
- Verify that production and testing equipment has been properly calibrated according to the calibration requirements as stated in the Quality Control manual.
- Verify mix designs are approved.
- Verify that the manufacturers detailed design information meets MDT requirements.
- Verify that documents are maintained for all suppliers of materials for the months the plant is producing.
 - Admixture Certifications
 - Gasket and Joint Sealant Material Certifications and Test Reports
 - Verify 12" to 33" have been sampled/tested at 1/300 frequency
 - Verify 36" and larger have been sampled/tested at 1/100 frequency
- Verify that test reports are maintained per ACPA and/or NPCA testing frequencies for the following:
 - Absorption Test Results
 - Three Edge Bearing Test
- Conduct Monthly or Frequency Based Inspection outlined in Sec. 4.2
- Sample concrete cylinders and reinforcing steel for Department testing.
- Verify that any deficiencies recorded from the previous inspection have been addressed.

4.2 Monthly or Frequency Based

Approximately once a month, unless another frequency is defined, inspect the fabricating plant's certification reports, test results, and other records from the previous inspection date to present. Ensure that the plant is 'Buy America' compliant for all steel products. Witness concrete cylinder testing is being performed correctly on certified equipment and meets MDT requirements.

Inspection Checklist

- Verify that any deficiencies recorded from the previous inspection have been addressed.
- Verify the following documentation has been maintained:
 - Buy America Certification
 - Cement Mill Reports
 - Sieve Analysis of Fine and Coarse Aggregates (once every 3 months)
 - Fly Ash Certifications
 - Other Cementitious Material Certifications and Test Reports
 - Cylinder Break Strength Results and Frequencies
- Verify fabricated cages and reinforcement conforms to MDT specifications.
- Verify a dimensional test report on one pipe size to ensure that they match the dimensions shown on the detailed drawings or AASHTO Standard Specifications.

- Observe or perform the following concrete tests:
 - Slump
 - Air Content
 - Temperature of the mix
 - Making of cylinders
 - Cylinder compression testing
 - Slump Flow (when applicable)
 - J Ring (when applicable)
 - Three Edge Bearing Test including Destructive Testing outlined in Section 4.3 (once every 3 months)

4.3 Observe destructive testing in the form of crushing precast pipe and other precast items in conjunction with the three edge bearing tests. Inspector will randomly select precast pipe sample to be tested. Verify the size, amount, and origin of the reinforcing steel. Coring and random inspections will be performed on Concrete Box culverts and miscellaneous precast items such as cutoff walls, cattle guard bases, FETS, and sound walls as directed by MDT.

5 Inspection Process for Non-Certified Plants

5.1 Inspect non-certified plants to confirm the products meet MDT specifications. Sample components i.e. concrete, reinforcing steel and other items. Check fabrication drawings and inspect the final product for quality. The plant's quality control program must be sufficient that MDT can confirm quality of materials and processes used. MDT level of inspection will vary according to Department needs.

- Verify personnel training and qualification records.
- Verify production and testing equipment has been properly calibrated.
- Verify mix designs are approved.
- Verify that the manufacturers detailed design information meets MDT requirements.
- Verify fabricated cages and reinforcement conforms to MDT specifications.
- Verify a dimensional test report on product to ensure that they match the dimensions shown on the detailed drawings or AASHTO Standard Specifications.
- Verify rate and frequency of testing is adequate and Quality Control records are maintained.
- Verify the following documentation has been maintained and required samples have been acquired:
 - Buy America Certifications and reinforcing steel samples
 - Cement Mill Reports
 - Aggregate samples for Sieve Analysis of Fine and Coarse Aggregates
 - Fly Ash Certifications
 - Other Cementitious Material Certifications and Test Reports
 - Cylinder Break Strength Results and Frequencies
 - Admixture Certifications
 - Gasket and Joint Sealant Material Certifications and Test Reports
- Observe or perform the following concrete tests:
 - Slump
 - Air Content
 - Temperature of the mix
 - Making of cylinders
 - Cylinder compression testing
 - Slump Flow (when applicable)
 - J Ring (when applicable)
 - Concrete Absorption
 - Three Edge Bearing Test or verification of test results

- Verify concrete cylinders are made and tested periodically to represent the concrete placed in all items.
- Concrete items other than concrete pipe will be entered on [Form 19A](#). These items, together with pipe too large to test, are represented by cylinder tests as outlined above.

6 Mark of Inspection

- 6.1 Products manufactured at a certified plant will not carry the mark of inspection. Non-certified manufacturers of concrete pipe and other concrete items must notify MDT when producing products for a project so that inspection arrangements can be made. All concrete products produced by a non-certified plant must carry a mark of inspection. (see Figure 1). This will be stamped on each section of product, by the inspector, where it will be clearly visible. The circle M indicates the product was inspected. Final acceptance will be made in the field.
- 6.2 If a product is to be rejected in the field, place an X next to the product identification stamp. This mark indicates that the product is rejected for all MDT projects. If the product requires repairs, but is not necessarily rejected; mark areas requiring repair to clearly designate and track what needs correction prior to acceptance.



Figure 1
CIRCLE M STAMP

METHODS OF SAMPLING AND TESTING
MT 111-12
SAMPLING, INSPECTION AND REPORTING
ON PRESTRESSED STRUCTURAL MEMBERS

1 Scope

- 1.1 This method is written to the individuals completing inspection and establishes a uniform procedure for the sampling, inspecting, and reporting of pre-stressed structural members.
- 1.2 Inspection Process Overview
- 1.2.1 Provide data to the field as it becomes available. Send original test results and reports to MDT Helena Materials Lab (to be placed in the job file), keep one copy in the Inspectors personal file, and send one copy to the Project Manager for the project file.
- 1.2.2 Send an inspection report with each beam to the project. Provide copies to the EPM, District Materials Lab, the Construction Bureau, and the Materials Bureau. This report must state that all of the materials used in the completed beams have been sampled, tested, and documented within reports that are in the possession of the Plant Inspector. Identify the beams by number and place in the report file as an indication that the beams are complete and acceptable subject to final field inspection.
- 1.2.3 The following links provide access to the Department's most current forms to be used during Prestress Inspection:

[Strand Tensioning & Cylinder Breaks](#)
[Form 45 – Rebar or Strand Sample](#)
[Form 48 – Shipping & Final Approval](#)
[Form 48A – Final Plant Inspection](#)
[Ready Mix Pour Record](#)
[Fabrication Inspection Report](#)
[Miscellaneous Inspection Report](#)

2 Referenced Documents***AASHTO Methods***

T 24 Obtaining and Testing Drilled Cores and Sawed Beams of Concrete
T 119 Slump of Hydraulic Cement Concrete
T 152 Air Content of Freshly Mixed Concrete by the Pressure Method
T 347 Slump Flow of Self-Consolidating Concrete

MT Materials Manual

MT 101 Making and Curing Compressive and Flexural Strength Test Specimens
MT 108 Sampling and Certification of Portland Cement
MT 117 Making and Curing Concrete Compressive and Flexural Strength Specimens in the Field for Self Consolidating Concrete (SCC)
MT 118 Method of Determining Air Content of Freshly Mixed Self Consolidating Concrete by the Pressure Method
MT 201 Sampling Roadway Materials

3 Materials

- 3.1 Materials used in the manufacture of pre-stressed beams are covered individually to avoid any misunderstanding on the part of the Plant Inspectors.
- 3.2 Sample and test aggregates will be sampled and tested quarterly in accordance with [MT 201](#). If new sources or deviations in material properties are apparent, resample aggregates as necessary for quality assurance.

- 3.3 Cementitious materials and admixtures are listed on the Department's Qualified Products. Verify that the mix design has been approved by the Helena Materials Bureau and appropriate material types and quantities are used.
- 3.4 Wire strand is tested in the Materials Bureau. Submit samples with a [Form 45](#), a copy of the mill test results of the load elongation curve, and associated documentation to meet Buy America requirements. The pre-stress plant is responsible for notifying the Plant Inspector when shipments of strand are received at the pre-stress plant. Sample strand by obtaining two 5 foot (1.5 m) long sections from a reel in the shipment. Submit these samples together with reel numbers, heat numbers, and all available information such as size, strength, etc., to the Materials Bureau for testing. Strand or any other item or ingredient used in the manufacture of a structural member prior to test results being received by the Plant Inspector are at the plant's risk. Reject members constructed with strand that does not meet Department requirements.
- 3.5 Sample reinforcing steel as each new shipment arrives at the plant. The pre-stress plant is responsible for notifying the Plant Inspector when shipments of rebar are received at the pre-stress plant. Submit two 3 foot (1.0 m) long samples of each bar size to the Materials Bureau with a [Form 45](#) and associated documentation required to meet Buy America requirements. Verify that all of the pertinent information is shown on the accompanying reports.
- 3.6 Witness the casting of cylinders representing release breaks by the pre-stress plant personnel. Witness or cast the cylinders for acceptance of twenty-eight day strength testing in accordance with [MT 101](#). Ensure that a set of at least 3 cylinders are fabricated for each pour in addition to release cylinders of a sufficient number to perform the required tests prior to release of the strand per Specification Subsection 553.03.11 Transfer of Pre-stress (minimum of 3 cylinders).

4 Plant Inspection and Acceptance

- 4.1 Review all documentation to verify conformity with contract requirements. For typical documentation requirements, see Specification Subsections 553.02 and 553.03.
- 4.2 Verify that the bed layout measurements have been checked by plant personnel and are in agreement with the approved shop drawings.
- 4.3 Verify strand patterns are in agreement with the approved shop drawings prior to tensioning. Check strands for strength and elongation (temperature correction) as provided on the approved shop drawings. Document and notify pre-stress plant personnel of any materials used in the beam that have not been sampled and tested in accordance with Section 3.1.3.
- 4.4 Verify that the rebar cage layout has been checked by pre-stress plant personnel and is in accordance with contract requirements. Document and notify pre-stress plant personnel of any materials used in beam that have not been sampled and tested in accordance with Section 3.1.4.
- 4.5 Verify that a final pre-pour inspection occurs prior to forms being set. Obtain a copy of the plant's pre-pour inspection form which must include details on the placement of inserts, bulkheads, bearing plate locations, and all other applicable details.
- 4.6 Visually check forms for proper placement. Verify that remaining steel and lift hooks have been included in accordance with approved shop drawings prior to concrete placement.
- 4.7 Witness concrete tests and cylinder breaks to verify requirements of Section 3.1.5 and Specification Sections 553.03.10 and 553.03.11 are met. After forms are removed, visually inspect before allowing the strand release (cutting of strands). If repairs are necessary, do not allow strand release until repairs are completed and are cured for a minimum of 24 hours.
- 4.7.1 Record pour placement times and field verification information using the "[Ready Mix Pour Record](#)" when pre-stress items are constructed using ready mix concrete.

- 4.8 Perform Final Inspection to ensure the finished member meets plan dimensions. Document the Final Inspection on [Form 48-A](#).
- 4.8.1 Mark each pre-stress member that conforms to specification requirements in all respects with a Circle M stamp (see Fig.1) before shipment from the plant. This identifying mark indicates that fabrication procedures, quality of materials and workmanship are satisfactory and the member is complete at the plant.
- 4.8.2 If deficiencies are identified, notify the Physical Testing Engineer, Bridge Bureau and Project Manager of the concerns and determine the corrective actions that are required. Do not mark these members with a Circle M stamp unless corrective actions have been completed and no additional concerns exist. Absence of a Circle M stamp indicates that the member is not complete or deficiencies have been observed by the Plant Inspector and additional corrective actions may be required. Note any deficiencies on the Pre-stress Beam - Final Plant Inspection Check List ([Form 48-A](#)). Noted deficiencies not corrected before shipment will be transmitted to the field with the Pre-stressed Beam Report Lab [Form 48](#).

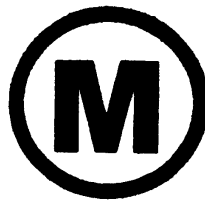

Figure 1
CIRCLE M STAMP

5 Field Inspection and Acceptance

- 5.1 When the product arrives at the job site, inspect members for shipping and handling damage or other defects. Notify the Project Manager of any damage or defects observed in the field.
- 5.2 Final acceptance of the member is made in the field in accordance with the contract. Ensure any deficiencies identified on the Pre-stressed Beam Report ([Form 48](#)) are addressed before final acceptance. Project Manager may reject any product that does not serve the necessary function or fails to meet contract requirements.

METHODS OF SAMPLING AND TESTING
MT 114-10
METHOD OF SAMPLING FOR CHLORIDE
CONTENT OF BRIDGE DECK CONCRETE

1 Scope

- 1.1 This is a method of sampling bridge deck concrete for chloride content.
- 1.2 See MDT Safety Policies and Procedures Manual.

2 Apparatus

- 2.1 *Coring Machine*
- 2.2 *Pachometer* - A pachometer is available upon request from the Materials Bureau
- 2.3 *Gas powered (110-115 Volt A.C.) Generator* with transport cart for operating drill
- 2.4 *Rotary Impact Drill* of heavy duty construction
- 2.5 *Bit* - 3/4 inch (19mm) diameter carbide steel bit
- 2.6 *Vacuum cleaner*
- 2.7 *Pliable sampling spoon* - Copper or flexible spoon 3 inches (75mm) in length and less than 3/4 inch (19mm) in width
- 2.8 *Plastic bottles* - Approximately 2 inches (50mm) tall and 1 inch diameter with sealable caps
- 2.9 *Ruler* with 0.10" increments and millimeters
- 2.10 *Paper labels*
- 2.11 *Fast Setting Grout* - "Set 45", "Rockite" or other fast setting grout
- 2.11 *Personal Protective Equipment* - Plastic goggles, hearing protection, gloves
- 2.12 *Plastic bottle* containing one of the following: distilled water, deionized water, ethanol (denatured) or methanol (technical grade)

3 Sampling

- 3.1 Chloride samples shall be taken before coring and in an area as close as possible and with the same types of distress (i.e. delaminations or cracking) as that intended for coring.
- 3.2 When coring or sampling for chlorides extreme caution will be required due to traffic hazards and use of power equipment. For standard safety practices refer to the MDT Safety Policies and Procedures Manual.

4 Procedure

- 4.1 The Bridge Plans are used to find approximate rebar location, cover over rebar, and thickness of concrete.
- 4.2 The pachometer is used to locate top layer of reinforcing steel and its depth.

- 4.3 Drill a hole 1/4 inch (6mm) deep and discard this portion of the sample by using the Vacuum cleaner. (See Note 1)
- 4.4 Drill the hole to a depth corresponding to the top of the rebar (see Note 1 and 2) and use copper or plastic spoon to collect minimum 10 g sample in plastic bottle labeled "A".
- 4.5 Clean the hole out with the Vacuum cleaner.
- 4.6 Drill hole to a depth of one inch below the top layer of reinforcing steel. Secure minimum 10 g sample of pulverized concrete with copper or plastic spoon and place into plastic bottle labeled as "B". (See Note 1 and 2)
- 4.7 Clean holes and fill with high strength epoxy grout patching compound such as "Set 45" or "Rockite".

Note 1 - The sketch as shown below defines the drilling depth for sampling:

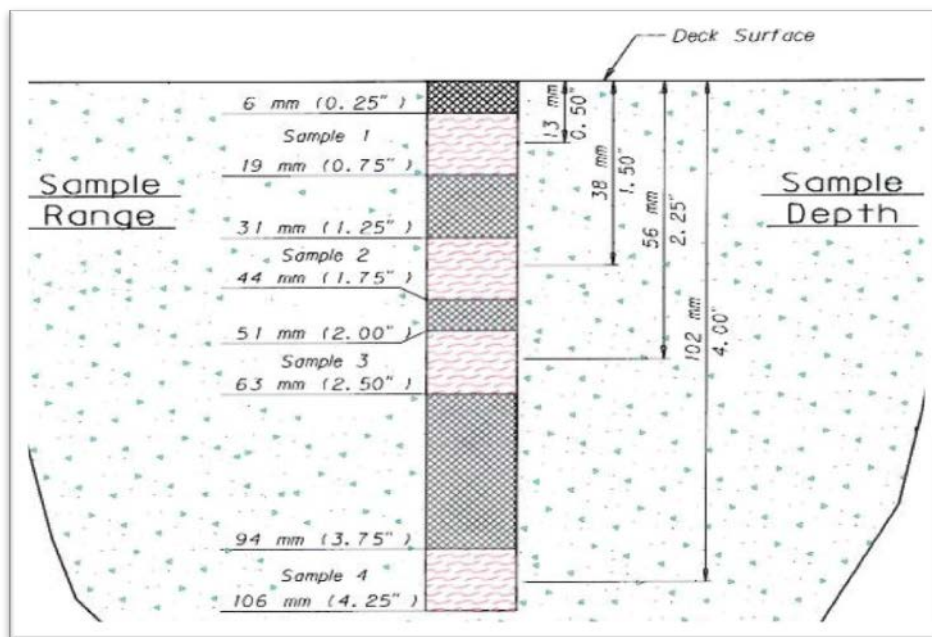

Cross Section Through Slab

Note 2 - During sample collection and pulverizing, personnel shall use caution to prevent contact of the sample with hands or other sources of body perspiration or contamination. Further, all sampling tools (drill bits, spoons, bottles, sieves, etc.) shall be washed with alcohol or distilled water and shall be dry prior to use on each separate sample. Alcohol is normally preferred for washing because of the rapid drying which naturally occurs.

5 Labeling

5.1 The following data will be written on each label and attached to each sample bottle:

- Project number and termini
- E.B. or W.B. lane
- Position in lane measured from curb
- Depth range of sample measured from top of deck and labeled as "A" or "B"; (See Note 1)
- Depth of reinforcing steel
- Core number cross reference
- Brief description of condition of area (i.e., delaminations, cracks).

6 Submittal

6.1 Cores with chloride samples will be submitted to the Materials Bureau.

METHODS OF SAMPLING AND TESTING
MT 117-17
MAKING AND CURING CONCRETE COMPRESSIVE AND
FLEXURAL STRENGTH TEST SPECIMENS
IN THE FIELD FOR SELF-CONSOLIDATING CONCRETE (SCC)
(Modified AASHTO T23)

MT 117 is identical to AASHTO T 23 except for the following stipulations:

1. Include the following Montana Materials Manual references.

MT Materials Manual

[MT 609 Field Numbering Concrete Cylinders](#)

2. In general, tamping via rodding or vibration is eliminated from the method for the testing of self-consolidating concrete. Specifically:

- A. Replace Section 1.1 with the following:

“This method covers procedures for making and curing cylindrical and beam specimens from representative samples of fresh self-consolidating concrete (SCC) for a construction project.”

- B. Eliminate Sections 5.4 and 5.5

- C. Replace Section 5.9 with the following:

“Slump Flow Apparatus--The apparatus for measurement of slump flow shall conform to the requirements of AASHTO T 347”.

- D. Eliminate Section 9.4

3. Replace Section 11.1 with the following:

Prior to transporting, cure and protect specimens as required in Section 10. Specimens shall not be transported until at least 8 h after final set. For transporting, efforts shall be made to protect the specimens from jarring, extreme changes in temperature, freezing, and moisture loss. Before transporting specimens from the field to the laboratory for testing, place specimens in sturdy boxes surrounded by a suitable cushioning material to prevent damage from jarring. During cold weather, protect the specimens from freezing with suitable insulation material. Prevent moisture loss during transportation by wrapping the specimens in plastic or wet burlap and by surrounding them with wet sand or sawdust or using tight-fitting plastic caps for plastic molds.

METHODS OF SAMPLING AND TESTING
MT 119-04
MOISTURE CORRECTION FOR CONCRETE MIX DESIGNS
(Montana Method)

1 Scope

- 1.1 This method describes the procedure for making a correction in the moisture requirement of a concrete mix, due to absorbed moisture. Concrete mix designs furnished by the Materials Bureau are based on saturated surface dry aggregate and the moisture correction must be made when concrete is produced. Moisture may be figured on a one sack basis or on a one cubic meter (one cubic yard) basis. A typical Class "A" mix for one sack of cement would be shown as: 94 - 213 - 190 - 190.

2 Moisture Requirement

- 2.1 The example mix makes no mention of water as it is controlled by slump requirements, but for the purpose of mix designs it is assumed to be 22.7 liters (6 gallons) per sack of cement. 22.7 liters (6 gallons) is not a specified amount to be used, and in fact, a lesser amount will most generally obtain the required slump. 22.7 liters (6 gallons) per sack is the maximum net amount of water which may be used under Montana Specifications, and includes free water in excess of water absorbed by the aggregates, additives, air entraining agents, etc.
- 2.2 It is impossible for the Materials Bureau to know in advance what the moisture condition of the aggregate stockpiles will be when concrete is ultimately produced, so the following procedure is to be observed.

3 Absorption of Fine Aggregate

- 3.1 Fine aggregate will always require an adjustment for the moisture content. Moisture content will seldom be less than 3% or more than 7%. The moisture correction is made by multiplying the aggregate weight shown by 100 plus the percentage of moisture in the material. If a moisture determination shows that the sand has 5% total moisture, multiply the sand weight shown by 105%. This would make the new sand weight about 102 Kg (224 pounds), which would total about 5 Kg (11 pounds) of water (free and absorbed) or approximately 5.0 liters (1-1/3 gallons) per sack.
- 3.2 If the fine aggregate has an absorption of 1.0%, the amount of water that can be counted as free water (mix water) would be computed as follows:
- 3.2.1 5.0% (total moisture) minus 1.0% (absorption) equals 4.0% free water.
- 3.2.2 96.6 Kg (213 lbs.) x .04 (4% free water) equals approximately 3.9 Kg (8.5 lbs.) free water.
- 3.2.3 Therefore, only 3.9 Kg (8.5 lbs.) of water would be counted as mix water.

4 Absorption of Coarse Aggregate

- 4.1 Medium and coarse aggregate are open-graded and free draining and will not usually require a correction for moisture unless they are being used directly from a washing plant or are being heated with live steam.
- 4.2 If a correction is deemed necessary, the procedure shown for fine aggregate will be followed.

5 Corrected Mix

- 5.1 The corrected mix would be: 94 - 224 - 190 - 190.

**METHOD OF SAMPLING AND TESTING
MT 121-16
EFFECT OF ORGANIC IMPURITIES IN FINE AGGREGATE
ON STRENGTH OF MORTAR
(Modified AASHTO T 71)**

MT 121 is identical to AASHTO T 71 except for the following stipulations:

1. Section 5.5.2 – Remove
2. Section 5.5.4 – Replace with the following:

“Rinsing the Aggregate – Continuously rinse the aggregate in a compact aggregate drum washer for two hours. Set the flow rate and angle of the wash water such that there are no losses of fine materials during the washing cycle.”

3. Section 5.5.5 – Remove
4. Section 6.3 – Remove
5. Sections 7.5 and 7.6 – Remove

METHODS OF SAMPLING AND TESTING
MT 122-17
OPTIMIZED AGGREGATE GRADATION FOR
HYDRAULIC CEMENT CONCRETE MIX DESIGNS

1 Scope

- 1.1 This method outlines the procedure for analyzing combined aggregate gradations for optimized concrete mix designs.

2 Referenced Documents

MT Materials Manual

MT 201 Sampling Roadway Materials
MT 202 Sieve Analysis for Fine and Coarse Aggregate

3 Apparatus

- 3.1 The apparatus required for sampling aggregates and performing sieve analysis will be as stated in [MT 201](#) and [MT 202](#).

4 Procedure:

- 4.1 Submit sieve analysis reports showing the cumulative combined percent passing, the cumulative combined percent retained, and the combined percent retained as shown in the sieve analysis Table 1. Include in the report, each individual aggregate gradation starting with the largest appropriate sieve for that material and including all the consecutive smaller sieve sizes through the #200 (75- μ m) sieve. They are to include: 1 1/2-in. (37.5-mm), 1-in. (25-mm.), 3/4-in. (19-mm), 1/2-in. (12.5-mm), 3/8-in. (9.5-mm), #4 (4.75-mm), #8 (2.3-mm), #16 (1.18-mm), #30 (60- μ m), #50 (300- μ m), #100 (150- μ m), and #200 (75- μ m) sieves. For coarse and intermediate aggregates, the #16 (1.18-mm) through #100 (150- μ m) sieves may be determined mathematically.
- 4.2 Submit the following charts used to perform aggregate gradation analysis:
- Coarseness Factor Chart (Figure 1)
 - 0.45 Power Chart (Figure 2)
 - Percent Retained Chart (Figure 3)
- 4.3 Perform a sieve analysis according to [MT 202](#) for each aggregate that will be used in the optimized mix design. Complete a sieve analysis with the percent passing and the relative percent volume of each aggregate used in the proposed mix design as shown in Table 1.

Table 1: Sieve Analysis

% Passing Agg (P)	Coarse Aggregate			Mid	Fine Aggregate		Combined Aggregate		Each Sieve
	1	2	3	1	1	2	% Passing (C _P)	% Retained (C _R)	% Retained (C)
Sieve	% Passing	% Passing	% Passing	% Passing	% Passing	% Passing	% Passing (C _P)	% Retained (C _R)	% Retained (C)
2 in.	100.0%	0.0%	0.0%	100.0%	100.0%	0.0%	100.0%	0.0%	0.0%
1 1/2 in.	100.0%	0.0%	0.0%	100.0%	100.0%	0.0%	100.0%	0.0%	0.0%
1 in.	100.0%	0.0%	0.0%	100.0%	100.0%	0.0%	100.0%	0.0%	0.0%
3/4 in.	96.0%	0.0%	0.0%	100.0%	100.0%	0.0%	97.8%	2.2%	2.2%
1/2 in.	63.0%	0.0%	0.0%	100.0%	100.0%	0.0%	79.7%	20.4%	18.2%
3/8 in.	28.0%	0.0%	0.0%	95.0%	100.0%	0.0%	60.0%	40.1%	19.7%
No. 4	9.0%	0.0%	0.0%	65.0%	100.0%	0.0%	46.8%	53.2%	13.2%
No. 8	2.0%	0.0%	0.0%	3.0%	96.0%	0.0%	35.9%	64.1%	10.9%
No. 16	1.0%	0.0%	0.0%	1.0%	76.0%	0.0%	28.0%	72.0%	7.9%
No. 30	0.0%	0.0%	0.0%	0.0%	45.0%	0.0%	16.2%	83.8%	11.8%
No. 50	0.0%	0.0%	0.0%	0.0%	17.0%	0.0%	6.1%	93.9%	10.1%
No. 100	0.0%	0.0%	0.0%	0.0%	6.0%	0.0%	2.2%	97.8%	4.0%
No. 200	0.0%	0.0%	0.0%	0.0%	1.0%	0.0%	0.4%	99.6%	1.8%
Pan	0.0%	0.0%	0.0%	0.0%	0.0%	0.0%	0.0%	100.0%	0.4%
Blend % (R)	55.0%	0.0%	0.0%	9.0%	36.0%	0.0%	100.0%		

5 Calculations

5.1 Calculate the cumulative combined percent passing each sieve using the following equation:

$$C_P = \sum \{(P_A)(R_A)\}$$

where:

C_P = Cumulative Combined % Passing

P_A = % Passing of Aggregate

R_A = Relative % of Aggregate

5.2 Calculate the cumulative combined percent retained on each sieve using the following equation:

$$C_R = 100\% - C_P$$

where:

C_R = Cumulative Combined % Retained

C_P = Cumulative Combined % Passing

- 5.3 Calculate the combined percent retained on each sieve using the following equation:

$$C = C_R - C_{RX}$$

where:

C = Combined % Retained

C_R = Cumulative Combined % Retained

C_{RX} = Cumulative Combined % Retained of next larger sieve size

6 Charts

- 6.1 *Coarseness Factor Chart*—Use the cumulative combined sieve analysis to determine the coarseness and workability factors. Plot the coarseness and workability factors on the Coarseness Factor Chart (Figure 1).

Determine the coarseness factor using the following equation:

$$CF = \left(\frac{S}{T} \right) \times 100$$

where:

CF = Coarseness Factor

S = Cumulative % Retained on the 3/8 in. Sieve

T = Cumulative % Retained on the No. 8 Sieve

The workability factor is the cumulative combined percent passing the No. 8 sieve. Increase the workability factor by 2.5 percentage points for every 94 lb. per cubic yard of cementitious material used in excess of 564 lb. per cubic yard in the mix design. Decrease the workability factor by 2.5 percentage points for every 94 lb. per cubic yard of cementitious material used below 564 lb. per cubic yard in the mix design. Do not adjust the workability factor if the amount of cementitious material is 564 lb. per cubic yard.

For Class Pave concrete, the coarseness factor and workability factor must plot within the workability box defined as follows:

- coarseness factor must not be greater than 68 or less than 52
- workability factor must not be greater than 38 or less than 34 when the coarse factor is 52
- workability factor must not be greater than 36 or less than 32 when the coarseness factor is 68.

For other classes of concrete the Workability Factor must plot within Zone II.

Aggregate blends that plot in Zone III may be considered for approval of a mix design if a ¾-inch nominal maximum or smaller size aggregate is utilized.

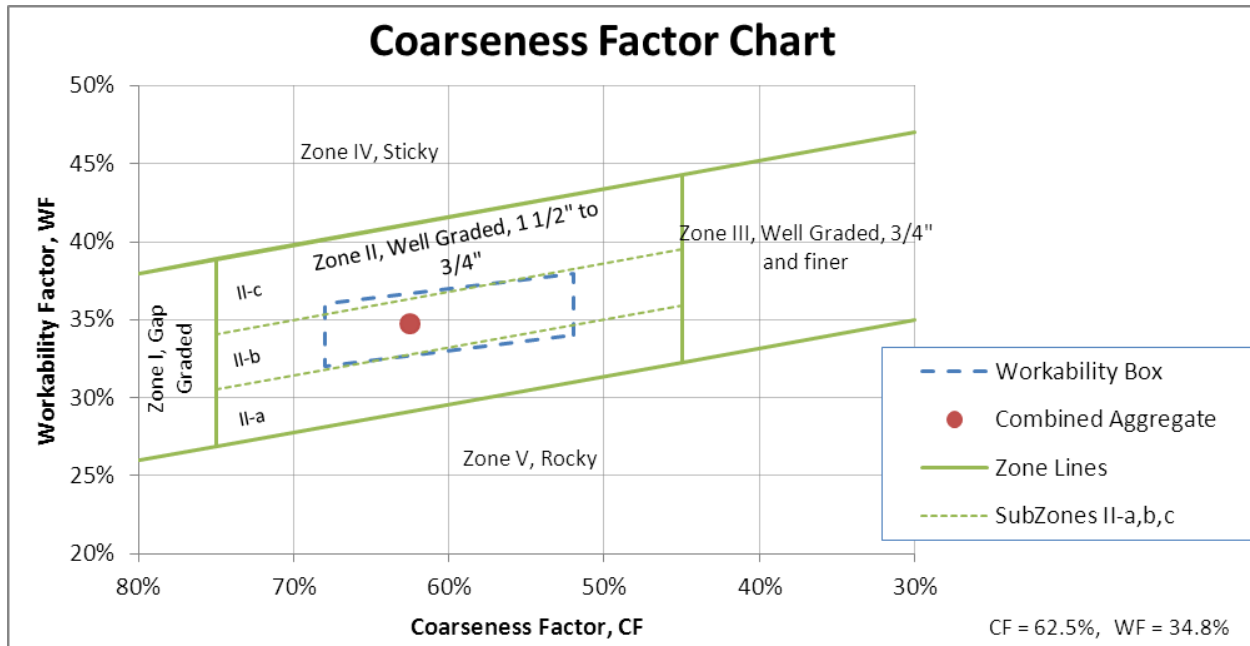

Figure 1: Coarseness Factor Chart

6.2 **0.45 Power Chart**—The 0.45 Power Chart (Figure 2) is created by plotting the cumulative percent passing (y-axis) vs. the sieve sizes raised to the power of 0.45 (x-axis). The cumulative percent passing should generally follow the maximum density line and should not deviate beyond the maximum and minimum tolerance lines. There may be a “hump,” beyond the tolerance line and above the maximum density line around the No. 16 sieve. There will always be a dip below the maximum density line around the No. 30 sieve. These deviations are typical and should not be cause for rejection of a gradation unless results from trial batches indicate workability problems.

The maximum density line is a straight line calculated with the following equation:

$$P = \left(\frac{d}{D}\right)^{0.45}$$

where:

P = % Passing

d = sieve size being considered

D = nominal maximum sieve size

The nominal maximum sieve size is one sieve larger than the first sieve to retain ≥10%.

The tolerance lines are straight lines drawn on either side of the maximum density line. Draw the tolerance lines from the origin of the chart to 100% of the next sieve size smaller and larger than the maximum density sieve size.

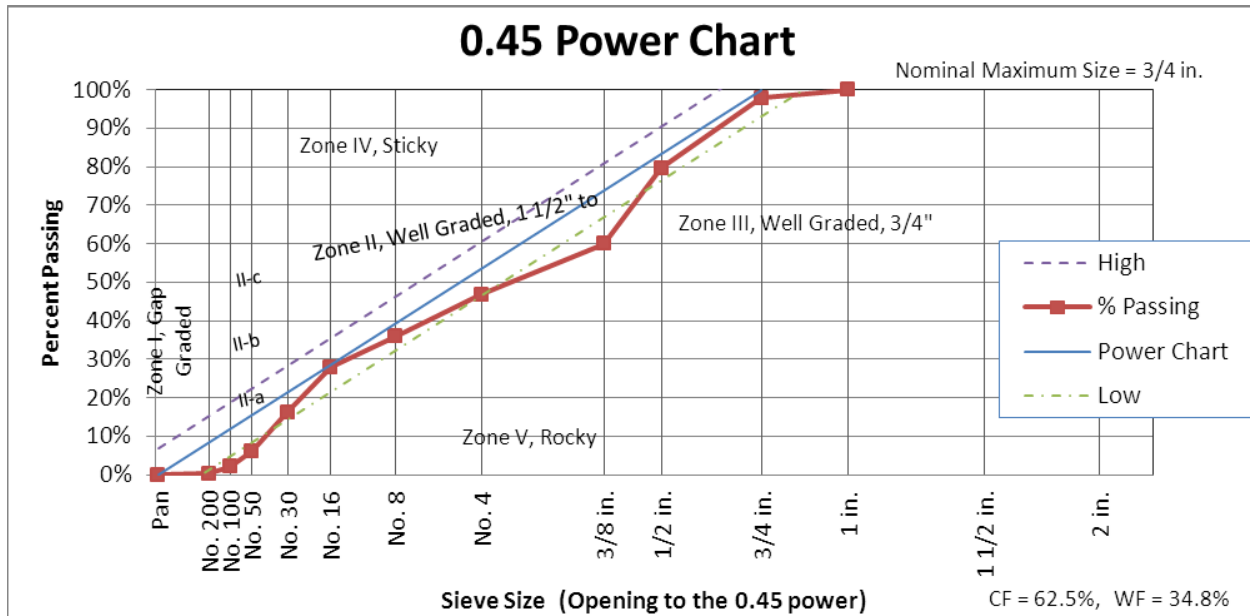

Figure 2: 0.45 Power Chart

6.3 *Percent Retained Chart*—Create the Percent Retained Chart (Figure 3) by plotting the combined percent-retained (y-axis) vs. the sieve sizes (x-axis). The sum of the percent retained on any two adjacent sieves, excluding the first and last sieve that retains material, must not be less than 13%.

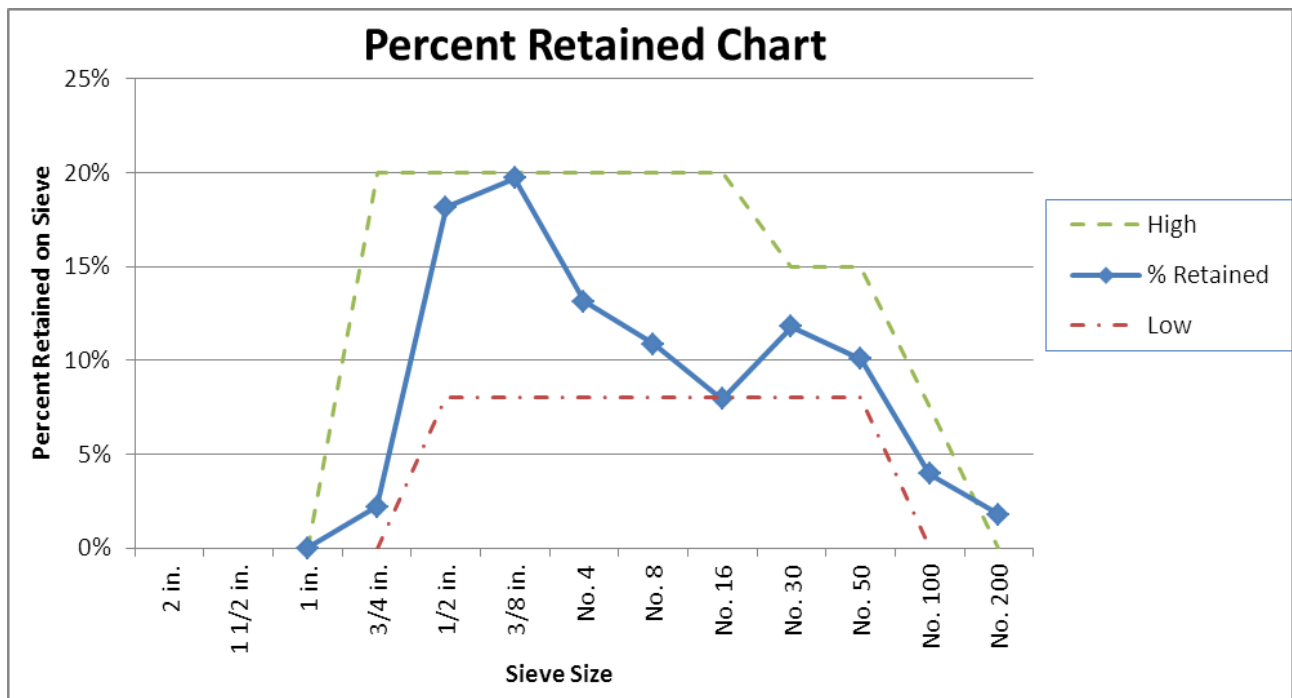

Figure 3: Percent Retained Chart

- 6.4 *MDT Optimized Gradation Worksheet* — May be used to perform the aggregate gradation analysis. It allows the user to input sieve analysis results and aggregate percentages, generating all of the previous charts.



MDT Optimized
Gradation Charts.XLS

- 6.5 *Selection of Optimized Aggregate Gradation* — Use the aggregate gradations and proportions that plot within the limits of the three charts described above as the basis for trial batches. Perform trial batches with varying aggregate proportions meeting the limits of the three previous charts to determine which concrete mix proportions meet contract requirements.

The Materials Bureau may allow the use of aggregate gradations and proportions that exceed the limits of the 0.45 Power Chart and the percent-retained chart. This may be permitted if the coarseness and workability factors plot within the workability box on the Coarseness Factor Chart and the trial batch results meet all contract requirements.

- 6.6 *Aggregate Gradation Monitoring and Aggregate Proportion Adjustment* — Monitor the aggregate gradation by plotting the results of each sieve analysis on the three previous charts. Perform sieve analysis on a lot by lot basis determined by [MT 601](#).

Any adjustments to the aggregate proportions during concrete production to keep the coarseness factor and workability factor plotted within the workability box on the Coarseness Factor Chart are subject to the Project Manager's approval.

**CURRENT DATE OF REVISION
MT 200 SECTION
SOIL AND AGGREGATE**

Test Method No.	<u>Title</u>	<u>Pages</u>	<u>Date of Publication or Revision</u>
MT 200	Vacant (Use AASHTO R 58 Dry Preparation of Disturbed Soil and Soil-Aggregate Samples for Test)		
MT 201	Sampling Roadway Materials	7 pp	Oct 2013
MT 202	Sieve Analysis for Fine and Coarse Aggregate.....	9 pp	Nov 2011
MT 203	Eliminated (Use AASHTO T 19 Bulk Density (Unit Weight) and Voids in Aggregate)		
MT 204	Eliminated (Use AASHTO T 84 Specific Gravity and Absorption of Fine Aggregate)		
MT 205	Eliminated (Use AASHTO T 85 Specific Gravity and Absorption of Coarse Aggregate)		
MT 206	Vacant (ELIMINATED)		
MT 207	Centerline Soil Survey	10 pp	Jun 2004
MT 208	Eliminated (Use AASHTO T 89 Determining the Liquid Limit of Soils and AASHTO T 90 Determining the Plastic Limit and Plasticity Index of Soils)		
MT 209	Eliminated (Use AASHTO T 96 Resistance to Degradation of Small-Size Coarse Aggregate by Abrasion and Impact in the Los Angeles Machine)		
MT 210	Moisture-Density Relations of Soils Using 5.5 lb. Rammer and 12 In. Drop.	1 pp	Dec 2016
MT 211	Eliminated (Use AASHTO T 134 Moisture-Density Relations of Soil-Cement Mixtures)		
MT 212	Determination of Moisture and Density of In-Place Materials	4 pp	Sep 2018
MT 213	Eliminated (Use AASHTO T 176 Plastic Fines in Graded Aggregates and Soils by Use of the Sand Equivalent Test)		
MT 214	Eliminated (Use AASHTO M 145 Classification of Soils and Soil-Aggregate Mixtures for Highway Construction Purposes)		
MT 215	Vacant (moved to MT 122)		
MT 216	Method of Sampling and Testing Cement Treated Base	5 pp	Oct 2013
MT 217	Eliminated (Use AASHTO T 335 Determining the Percentage of Fracture in Coarse Aggregate)		
MT 218	Determining Relative Compaction and Percent Moisture.....	2 pp	Jun 2004
MT 219	Controlling Compaction Using a Control-Strip Test Section Technique with Nuclear Gauges	3 pp	Aug 2019
MT 220	Eliminated (Use AASHTO T 100 Specific Gravity of Soils)		
MT 221	Eliminated (Use AASHTO T 255 Total Evaporable Moisture Content of Aggregate by Drying)		
MT 222	Eliminated (Use AASHTO T 191 Density of Soil In-Place by the Sand-Cone Method)		
MT 223	Eliminated (Use AASHTO T 112 Clay Lumps and Friable Particles in Aggregate)		
MT 224	Vacant (ELIMINATED)		
MT 225	Vacant (ELIMINATED)		
MT 226	Maximum Acceptable Deviations in Sieve Analysis of IA Samples	1 pp	Dec 2016
MT 227	Eliminated (Use AASHTO T 265 Laboratory Determination of Moisture Content of Soils)		

**CURRENT DATE OF REVISION
MT 200 SECTION
SOIL AND AGGREGATE**

<u>Test Method No.</u>	<u>Title</u>	<u>Pages</u>	<u>Date of Publication or Revision</u>
MT 228	Method of Establishing Field Target Density for Cement Treated Base Density Control	1 pp	Oct 2013
MT 229	Procedure for Solids-Water-Voids Relations of Soil Masses.....	12 pp	Sep 2015
MT 230	Moisture-Density Relation of Soils Using a 10 lb Rammer and 18 In. Drop..	1 pp	Dec 2016
MT 231	Vacant (ELIMINATED)		
MT 232	Soil Corrosion Test	3 pp	Dec 2016
MT 233	Eliminated (<i>Use AASHTO T 327 Resistance of Coarse Aggregate to Degradation by Abrasion in the Micro-Deval Apparatus</i>)		

METHODS OF SAMPLING AND TESTING
MT 201-13
SAMPLING ROADWAY MATERIALS

1 General

- 1.1 Sampling for evaluation of potential aggregate sources should be performed by a responsible, trained and experienced person. Because of the wide variety of conditions under which sampling may be done, it is not possible to describe detailed procedures applicable to all circumstances.
- 1.2 The sample bags must be tightly-woven and durable so that the required amount of sample can be shipped without rupture of the bag or loss of fine material through the fabric. Also, when tied, as in 1.3, the bag must be sealed tightly enough to prevent loss or contamination of the material.
- 1.3 Samples shall be double-tied as close to the gravel as possible with the necessary papers between the double tie. This procedure insures a good sample together with a legible laboratory sheet.

2 Referenced Documents***MT Materials Manual***

MT 101 Making and Curing Concrete Compressive and Flexural Strength Field Test Specimens
 MT 202 Sieve Analysis of Fine and Coarse Aggregate
 MT 207 Centerline Soil Survey
 MT 210 Moisture Density Relation of Soils Using a 5.5 lb. Rammer
 MT 218 Determining Relative Compaction and Percent Moisture
 MT 230 Moisture Density Relation of Soils Using a 10 lb. Rammer
 MT 601 Materials Sampling, Testing and Acceptance Guide
 MT 607 Procedure for Reducing Filed Samples to Testing Size

3 Number of Samples

- 3.1 The frequency of sampling as described in this procedure is the minimum required and more should be taken if deemed necessary.

4 Pre-construction Proposed Surfacing Sampling

- 4.1 Proposed surfacing samples should represent a vertical cross-section of the proposed source.
- 4.1.1 Describe each site or area investigated with each test hole, boring or test pit clearly located (horizontally and vertically) with reference to some established coordinate system or permanent monument on an area map or sketch.
- 4.1.2 Log each test hole, boring, test pit or cut-surface exposure with the field description and location of each material encountered clearly shown by Montana Department of Transportation symbols and word descriptions used on Form 30. An example of Form 30 is in MT 207.
- 4.1.3 Each aggregate layer that is included in the sample should be noted along with the depth of the water table if it is encountered should be shown on the log of test holes.
- 4.2 Overburden or clay seams may be sampled separately.
- 4.3 Rocks larger than 6 inches (150mm) in diameter shall not be included in the sample. However, the estimated percentage of rock larger than 12 inches (300mm); between 6 and 12 inches (150 and 300mm); between 4 and 6 inches (100 and 150mm); and less than 4 inches (100mm) in diameter shall be shown on the Prospected Area Report.

- 4.4 Representative samples shall be taken on the following basis:
 - 4.4.1 Each sample shall be a minimum of 150 pounds (68 Kg).
 - 4.4.2 Not less than 3 samples shall be taken from any proposed source.
 - 4.4.3 Up to 50,000 cubic yards (38,230 cubic meters) - a minimum of 3 samples.
 - 4.4.4 50,000 to 100,000 cubic yards (38,230 to 76,460 cubic meters) - 3 to 5 samples.
 - 4.4.5 100,000 to 150,000 cubic yards (76,460 to 114,690 cubic meters) - 5 to 8 samples.
 - 4.4.6 150,000 to 200,000 cubic yards (114,690 to 152,920 cubic meters) - 8 to 10 samples.
 - 4.4.7 Providing the material is uniform, one sample may represent material from as many as ten test holes in large areas if provisions 4.4.1 through 4.4.6 above are met.
 - 4.4.8 For large sources, a suggested sampling sequence is to take samples around the perimeter of the source with additional samples taken toward the middle to check for uniformity. Each proposed source is unique, however, and the final sampling sequence shall be determined by the District Materials Supervisor or Area Lab Supervisor.
- 4.5 The District or Area laboratory will determine the gradation, LL, PL, PI, soil class and 24-hour volume swell and submit to the Materials Bureau on a form 123. Also, a visual examination by the Materials Supervisor will be made. An interpretation of these results will determine if the material in the proposed source is worthy of further consideration.
 - 4.5.1 Predominately Unacceptable - If the tests show the material to be predominately unsatisfactory and material of a better quality is available, no further consideration shall be given this source.
 - 4.5.2 Uniformly Acceptable - If the tests indicate the material is uniformly satisfactory, at least one sample for every six tested in the District or Area laboratory (a minimum of three) shall be sent to the Materials Bureau. Each sample shall consist of 1-75 lb. (34 Kg) split for wear, gradation and other correlations (see note 1). Also, a 300 lb. composite sample for Mix design testing shall be submitted for these areas. Additionally, one 180 lb. (32 Kg) composite sample per source is required for Sodium Sulfate and Micro-Deval testing.
 - 4.5.3 Spotty sources - If the tests indicate the material is spotty, at least one sample for every six tested in the District or Area laboratory (a minimum of one) for each of the areas (satisfactory, questionable, and unsatisfactory) shall be sent to the Materials Bureau for wear test, gradation check, evidence of disintegration, and other correlations. Also, a 300 lb. composite sample for Mix design testing shall be submitted for these areas. Additionally, one 180 lb. (32 Kg) composite sample per source is required for Sodium Sulfate and Micro-Deval testing.

Number of Representative Pounds from Each Hole to Make Composite				
Holes	Sodium Sulfate		Micro Deval	
	Lbs.	Kg	Lbs.	Kg
2	120	54	60	27
5	24	11	12	5
10	12	5	6	3
15	8	4	4	2

Note 1 – Each area within a source that exhibits different physical characteristics should be sampled completely as per 4.5.2. In a large volume area one sample may be a composite of a series of holes of uniform material (example: sample number 1 may be a composite of holes 1 through 6; sample number 2 - holes 7 through 12; sample number 3 - holes 13 through 20, etc.) The example cited above is to be used as a guide only.

- 4.5.4 Material for each portion of the composite sample shall be obtained by quartering, splitting, recombining and splitting again according to MT 607 so that a homogenous mix is obtained. The material will be split so that no more than 77 lbs. (35 Kg) are placed in one bag.
- 4.5.5 The Core Drill Section, under the direction of the Geotechnical Section, can be utilized in problem areas where conventional equipment is inadequate. Assistance, either geologic or drilling, can be provided usually within a period of a month or six weeks.

5 Laboratory Form No. 99

- 5.1 The "Field Sample Analysis Report" Form No. 99 is to be used in reporting district or area laboratory tests. This information will be transferred to the "Available Surfacing Material Report" in Helena and will be available to prospective bidders, along with the usual Materials Bureau test results.
- 5.2 The District Materials Supervisor or Area Lab Supervisor is to use his experience and engineering judgment to give a summation of all information such as the past history of the source and his comments and recommendations regarding the laboratory test data which would include a statement as to which holes were represented by the Sodium Sulfate and Micro-Deval samples. This information will be placed on the bottom portion of Lab Form No. 99. However, the acceptance or rejection of the source will be the responsibility of the Materials Bureau in Helena when all testing is complete.

6 Laboratory Form No. 92

- 6.1 The field information on Laboratory Form No. 92 shall include a correct legal description of the deposit. In some cases, it may be necessary to have a survey party retrace the boundary lines and make section line ties before right-of-way negotiations can be completed. Where deposits are located adjacent to the highway right-of-way, the boundary lines of the deposit should be tied to the centerline and shown on Laboratory Form No. 92 so that a legal description can be prepared without any further field work. Under some circumstances, the Department of Transportation will obligate by purchase or option surfacing material sources for future construction projects and maintenance use.
- 6.2 Form No. 92 "Prospected Area Report" must be completely filled out especially with reference to definite location, total yardage represented by the samples, ownership, and depth of overburden. The haul distance shall be reported to the nearest one-tenth mile over the shortest and most practical route from the deposit to a definite station on the project.
- 6.3 A sketch shall be attached Form No. 92 showing the boundary lines of the deposit with all dimensions and ties neatly plotted to a scale that is indicated on the sketch. All test holes shall be numbered and shown in their correct location.
- 6.4 In those cases where areas are being explored on which data has been previously submitted, a new "Prospected Area Report" shall accompany the new sampling showing any laboratory numbers previously assigned.

7 Reports on Proposed Surfacing Sources

- 7.1 The Materials Bureau will issue a final report based on an evaluation of the district or area laboratory test data, the recommendations of the District Materials Supervisor or Area Lab Supervisor, and an interpretation of tests performed by the Materials Bureau.

8 Preconstruction Binder Samples

- 8.1 Binder samples shall be taken incidental to all proposed gravel source exploration. A 25 lb. (11 Kg) sample from each distinct type proposed for use shall be taken and tested in the district or area laboratory. Binder samples need not be sent to the Materials Bureau unless an unusual problem arises.

9 Size of Samples: Required for District, Area and Materials Bureau Testing

9.1 The sample size depends on 100% of the aggregate passing the specified sieve size. The amounts specified in the table below provide adequate material for routine testing (gradation, LL, PI, volume swell, etc.). Minimum Field Test sample sizes are in MT 202.

SPECIFIED 100% PASSING SIEVE SIZE	MINIMUM WEIGHT OF SAMPLE (See Note 2)
4.75 mm (4 Mesh)	14 Kg (30 lb.)
9.5 mm (3/8 Inch)	14 Kg (30 lb.)
12.5 mm (1/2 Inch)	14 Kg (30 lb.)
16.0 mm (5/8 Inch)	14 Kg (30 lb.)
19.0 mm (3/4 Inch)	14 Kg (30 lb.)
25.0 mm (1 Inch)	35 Kg (77 lb.)
37.5 mm (1½ Inch)	35 Kg (77 lb.)
50 mm (2 Inch)	35 Kg (77 lb.)
63 mm (2½ Inch)	35 Kg (77 lb.)

Note 2 – The sample shall be obtained by quartering or splitting to insure a representative sample. If necessary, the representative sample shall be split again so that no more than 77 lbs. (35 Kg) are placed in two bags.

10 Sampling from Stockpiles

10.1 When such sampling is necessary, every effort should be made to enlist the services of power equipment to develop a separate, small sampling pile composed of materials drawn from various levels and locations in the main pile after which several increments may be combined to compose the field sample.

10.2 Coarse Aggregate Stockpiles – Where power equipment is not available, samples from stockpiles should be made up of at least three increments taken from the top third, at the midpoint, and at the bottom third of the volume of the pile. A board shoved vertically into the pile just above the sampling point aids in preventing further segregation.

10.3 Fine Aggregate Stockpile – A suggested sampling procedure for fine aggregate would be to remove the outer layer, which may have become segregated and take the sample from the material beneath. Sampling tubes approximately 1¼ inches (30-mm) minimum by 6 feet (2-m) minimum in length may be inserted into the pile at random locations to extract a minimum of five increments of material to form the sample.

11 Production Sampling

11.1 Production samples shall be taken in three equal increments from a stopped belt or with an automatic sampling device and combined to make the sample. Such samples shall be reduced to testing size, according to MT 607, Method A or Method B.

12 Windrow Sampling (Cement Treated Base and Cold In-Place Recycle)

12.1 Samples should be composed of a number of samples taken at various points along the windrow, combined and reduced to testing size according to MT 607, Method A or Method B.

13 Pug Mill – Mixed Aggregate Sampling

13.1 Samples for gradation and fracture testing shall be taken from a minimum of three increments from the processed material on the roadway after lay down.

13.2 Samples for crushed cover material gradation and fracture will be taken at the most convenient point before application determined by the engineer.

13.3 Samples for other specified properties will be taken at the point of production.

14 Sampling from Roadway

- 14.1 Samples from the roadway (minimum of three increments) should be taken for the full depth of the material, taking care to exclude any underlying material. Where necessary, place templates on the existing roadway to separate the underlying material from the sample. The sample shall be taken from the processed material on the roadway after laydown.
- 14.2 District or Area labs will determine the gradation, LL, PL, PI and soil class for Soil Survey "R" Value samples. The results will be reported on a form 123 which will accompany the sample to the Materials Bureau.

15 "Special Borrow"

- 15.1 District or Area labs will determine the gradation, LL, PL, PI and soil class for Special Borrow "R" Value samples. The results will be reported on a form 123 which will accompany the sample to the Materials Bureau.

16 Reduction of Sample Size by Quartering or Splitting

- 16.1 The procedure for reducing the size of field sample of aggregate is described in MT 607.

17 Required Production Samples other than Aggregates for Plant Mix

- 17.1 Field testing for Acceptance shall conform to the frequency as shown in MT 601, under "Aggregate Surfacing".

18 Independent Assurance Samples

- 18.1 The District or Area laboratories shall take Independent Assurance samples in accordance with the frequency shown in MT 601. The same sample shall be tested by each lab, with all the material returned to the sample.
- 18.2 If discrepancies occur between the District or Area laboratory and the Acceptance samples, the District or Area laboratory will investigate and change any procedures or equipment found to be causing the differences.
- 18.3 If differences are found to exist between the District or Area laboratory and the Materials Bureau, the Materials Bureau will have the authority to investigate all of the testing procedures and make any changes found necessary.

19 Plant Mix Aggregates

- 19.1 Sampling will be in accordance with the sample size and frequency described in MT 601 and the following:
- 19.2 WHEN STOCKPILED - In order to establish a stockpile average, the samples shall be secured and tested as the stockpile is being produced.
- 19.3 BATCH TYPE HOT PLANT- A representative sample of dried aggregate shall be provided by means of an approved sampling device.
- 19.4 DRYER DRUM HOT PLANT - A representative composite sample shall be provided, by means of an approved sampling device, at a point just prior to the aggregate entering the dryer drum mixer.
- 19.5 CONTINUOUS FLOW HOT PLANT - A representative sample of dried aggregate shall be provided by means of an approved sampling device.

20 Aggregates for Design

- 20.1 MAINTENANCE MIX DESIGN - The amount of material submitted to the Materials Bureau for a proposed mix design shall be as follows: Plant Mix Aggregate - 300 lbs. (136 Kg), Seal and Cover Aggregate - 150 lbs. (68 Kg).
- 20.2 The sample shall be prepared in the district or area laboratory as described in 19.2 and 19.3.
- 20.3 Non-Quality Assurance Projects
 - 20.3.1 When a satisfactory stockpile average has been established, a sieve analysis shall be performed, in the District or Area laboratory, on a representative sample of the stockpiled material.
 - 20.3.2 Compare the sieve analysis obtained in paragraph 19.2 above, to the established stockpile average.
 - 20.3.3 If the minus 4 mesh portion of the sample is within plus or minus 2% and the minus 200 mesh portion is within plus or minus 1% of the stockpile average, the sample may be submitted to the Materials Bureau for a mix design, without further preparation.
 - 20.3.4 If the sample does not meet the above criteria, it will be necessary to adjust the gradation, in the District or Area laboratory, to allowable variations described in paragraph 20.2.3 above, before it is shipped to the Materials Bureau.
 - 20.3.5 The stockpile average shall be shown on the laboratory work sheet that accompanies the sample.

21 Mineral Filler

- 21.1 One 2.3 Kg (5 lb.) sample per project of mineral filler will be sampled and submitted to the Materials Bureau for testing and acceptance.

22 Compaction Samples

- 22.1 The District or Area laboratory shall run at least one sample from each different soil type using the methods described in MT 210 or MT 230. It will not be necessary to submit compaction samples to the Materials Bureau. If the material being sampled consists of fine material, 30 pounds (14 Kg) shall be obtained. If the material consists of coarse and fine material, the sample shall be large enough to yield 30 lbs. (14 Kg) of the fine material (minus 4 mesh).

23 Field Density Tests

- 23.1 Field density tests shall be taken in accordance with MT 601, under "Density Control, Embankment" and MT 218 (Determining Relative Compaction and Percent Moisture).

24 Concrete Aggregates

- 24.1 Concrete aggregate samples shall be submitted in accordance with MT 601.

25 Concrete Test Specimens

- 25.1 Concrete compressive and flexural strength test specimens will be made and cured in accordance with MT 101.

26 Cement Treated Base

- 26.1 Cement Treated Base shall be sampled in accordance Section 12.1 or Section 14.1, and MT 601.

27 Field Construction Sampling

- 27.1 Samples for soil classification and “R” value shall be obtained from the top 2 feet (0.6 meters) of the sub-grade. Sample frequency will be one sample every 1000 feet (305 meters) for projects with 3 or more cuts or fills per mile. If the project has fewer than 3 cuts or fills per mile the sample distance is extended to 2000 feet (610 meters).
- 27.2 District/Area lab personnel will determine the soil classification. If the soil class is not equal to or better than that used by the Surfacing Design Unit to determine the typical section, then samples for “R” value determination are to be submitted to the Materials Bureau in Helena.
- 27.3 Samples for soil classification and/or “R” value are not required when the top two feet of subgrade is constructed with Special Borrow tested and accepted at the borrow source. However, samples may be obtained from the roadway and tested to ensure the in-place material meets the contract requirements. Take samples whenever the material delivered to the roadway appears to differ from samples used for pit acceptance. Sample frequency is at the discretion of the Project Manager.

Note 3 – These samples are as a design check only. Sampling every 1000 feet (305 meters) is a general guide and some discretion should be used. For example, it may be advisable to take more samples in fill sections than cut sections, or if there is an obvious change in the soil conditions or soil class, etc. No samples will be required for typical sections with a design “R” of 5 or less or for soils classified as A-6 or A-7.

METHODS OF SAMPLING AND TESTING
MT 202-11
SIEVE ANALYSIS OF FINE AND COARSE AGGREGATES
(Modified AASHTO T 11 AND T 27)

1 Scope

- 1.1 This method covers the determination of the particle size distribution of fine and coarse aggregates by sieving.
- 1.2 Material passing the 4.75 mm (no. 4) sieve will be washed. Clay particles and other aggregate particles that are dispersed by the wash water, as well as water-soluble materials, will be removed from the aggregate during testing.

2 Referenced Documents**AASHTO**

- M 231 Weighing Devices Used in the Testing of Materials
- T 11 Materials Finer Than 75- μ m (No. 200) Sieve in Mineral Aggregates by Washing
- T 27 Sieve Analysis of Fine and Coarse Aggregates

MT Materials Manual

- MT 201 Sampling Roadway Materials
- MT 405 Wire Cloth Sieves for Testing Purposes
- MT 607 Reducing Field Samples of Aggregate to Testing Size

3 Definitions

- 3.1 *Constant Mass* – Constant mass has been reached when there is less than a 0.1 percent change in mass over a monitored drying time. For an oven ($110 \pm 5^\circ \text{C}$ ($230 \pm 9^\circ \text{F}$)), an additional 30 minutes of drying. For an uncontrolled heating source such as hot plates, an additional 20 minutes of drying, or microwaves, an additional 10 minutes of drying.

4 Apparatus

- 4.1 *Balance* – The scale or balance for the coarse 4.75 mm (plus 4 mesh) material shall have a sensitivity of 0.01 pounds or 0.01 kilograms. The scale or balance for the fine 4.75 mm (minus 4 mesh) material shall have a sensitivity of 0.1 gram.
- 4.2 *Sieves* – The sieve cloth shall be mounted on substantial frames constructed in a manner that will prevent loss of material during sieving. Suitable sieve sizes shall be selected to furnish the information required by the specifications covering the material to be tested. The sieves shall conform to the requirements of MT 405, Wire Cloth Sieves for Testing Purposes.
- 4.2.1 *Sieves* – A nest of two sieves, the lower being a 75- μ m (No. 200) sieve and the upper being a sieve with openings in the range of 2.36 mm (No. 8) to 1.18 mm (No. 16), both conforming to the requirement of MT 405.
- 4.3 *Container* – A container sufficient in size to contain the sample covered with water and to permit vigorous agitation without inadvertent loss of any part of the sample or water.
- 4.4 *Heat Source* – A heat source capable of drying samples in accordance with Section 5.
- 4.5 *Mechanical Sieve Shaker* – A mechanical sieving device shall create motion of the sieves to cause the particles to bounce, tumble, or otherwise turn so as to present different orientations to the sieving surface. The sieving action shall be such that the requirement for sieving thoroughness as described in Section 7.3 is met within a reasonable amount of time.

5 Preparation of Samples

- 5.1 Samples for sieve analysis shall be prepared in accordance with MT 607, Reducing Field Samples of Aggregates to Testing Size. The samples shall be the mass desired when dry. The selection of samples of an exact predetermined mass shall not be permitted.
- 5.2 Dry the sample to a constant mass. For control purposes, particularly where rapid results are desired, it is generally not necessary to dry coarse aggregate to a constant mass for the sieve analysis test. The results are insignificantly affected by the moisture content unless the nominal maximum size is smaller than 12.5 mm (½ in.), or the coarse aggregate contains appreciable material finer than 4.75 mm (No. 4); or the coarse aggregate is highly absorptive (a lightweight aggregate, for example). Samples may be dried at higher temperatures associated with the use of hot plates or other uncontrolled heat sources without affecting results, provided steam escapes without generating pressures sufficient to fracture the particles, and temperatures are not so great as to cause chemical breakdown of the aggregate.

Note 1 – Samples taken for Liquid Limit, Plastic Limit, and Plasticity Index shall be air dried or dried at a temperature no greater than 140°F or 60°C.

Note 2 – Air drying is an acceptable method.

- 5.3 Representative samples will be graded to determine the percentage of fine material adhering to the coarser fractions.
- 5.4 *Fine Aggregate* – The test sample of fine aggregate shall weigh, after drying, approximately the following amount:

Aggregate with at least 95% passing a 2.36 mm (No. 8) sieve . . . 100g
 Aggregate with at least 85% passing a 4.75 mm (No. 4) sieve
 and more than 5% retained on a 2.36 mm (No. 8) sieve 500g

- 5.5 *Coarse Aggregate* – The mass of the test sample of coarse aggregate shall conform with the following:

Specified 100% Passing Sieve Size		Min. Field Test Sample Size*	
mm	(in)	Kg	(lb)
*9.5	(3/8)	6.8	(15)
*12.5	(1/2)	6.8	(15)
*19.0	(3/4)	9.1	(20)
*25.0	(1)	11.3	(25)
*37.5	(1½)	15	(33)
50	(2)	20	(44)
63	(2½)	35	(77)

Note 3 – For cover material, concrete aggregate, and samples that require a wear, cleanliness value test, the sample size sent to Helena must be doubled.

- 5.6 *Coarse and Fine Aggregate Mixtures* – The mass of the test sample of coarse and fine aggregate mixtures shall be the same as for coarse aggregate.

6 Procedure for Calculating Clinging Fines

- 6.1 Follow the procedure in Section 5 for the original test. Save the plus 4.75 mm (4 mesh) material.
- 6.2 Wash the plus 4.75 mm (4 mesh) material over a protected 75 µm (200 mesh) screen. In most cases it is not necessary to rewash the minus 4.75 mm (4 mesh) material. Dry and re-screen over the original sized screens. Use the original mass of sample taken for the calculation of the plus 4.75 mm (4 mesh) percentages.

- 6.3 Obtain the difference between the original plus 4.75 mm (4 mesh) material and the washed plus 4.75 mm (4) material. Record for use in calculations of the minus 4.75 mm (4 mesh) material. To convert from the pounds of minus 4 mesh material to grams, multiply by 453.6.

Example: $(0.39 \text{ pounds}) \times (453.6) = 176.9 \text{ grams}$.

Use the percentage difference passing the 4.75 mm (4 mesh) divided by the before wash weight to get the reciprocal for multiplication.

Example: $(1.55\%)/176.9 \text{ g} = 0.00876$

- 6.4 The total percent clinging fines is the difference in percent of the plus 4.75 mm (4 mesh) screen sizes.

Example: $55.61\%(\text{dry}) - 54.06\%(\text{washed}) = 1.55\%$ (report as 1.6%)

7 Procedure for Aggregate without Clinging Fines

- 7.1 The total sample as prepared in Section 5 shall be separated into a series of sizes. To determine compliance with the specifications for the material under test, avoid overloading the screens.
- 7.2 Coarse Aggregate: Plus 4.75 mm (4 Mesh) Material – The individual mass of the plus 4.75 mm (4 mesh) portion of the sample, retained on each screen, shall be determined and recorded to the nearest 0.01 of a pound or 0.01 kilogram.
- 7.2.1 The individual portions shall be saved until the entire plus 4.75 mm (4 mesh) portion of the sample has been screened, weighed and the weights recorded, before any of the material is discarded.
- 7.2.2 The total amount of material finer than the plus 4.75 mm (4 mesh) sieve may be determined by subtracting the total mass of material retained on the plus 4.75 mm (4 mesh) sieve from the total mass of the initial dry sample being tested.
- 7.3 Fine Aggregate: Minus 4.75 mm (4 Mesh) Material – At the completion of the sieving as described in Section 7.2, the entire minus 4.75 mm (4 mesh) portions shall be thoroughly mixed and reduced to a minimum of 500 grams.
- 7.3.1 After drying the sample to a constant mass and weighing, place the test sample in the container and add sufficient water to cover it. A detergent, dispersing agent, or other wetting solution may be added to the water to assure a thorough separation of the material finer than the 75 μm (No.200) sieve from the coarser particles (Note 4). Agitate the sample with sufficient vigor to result in complete separation of all particles finer than the 75 μm (No. 200) sieve from the coarser particles, and to bring the fine material into suspension. Immediately pour the wash water containing the suspended and dissolved solids over the nested sieves, arranged with the coarser sieve on top. Take care to avoid, as much as feasible, the decantation of coarser particles of the sample.

Note 4 – There should be enough wetting agent to produce a small amount of suds when the sample is agitated. The quantity will depend on the hardness of the water and the quality of the detergent. Excessive suds may overflow the sieves and carry some material with them.

- 7.3.2 Add a second change of water (without wetting agent) to the sample in the container, agitate, and decant as before. Repeat the operation until the wash water is clear.

Note 5 – If mechanical washing equipment is used, the charging of water, agitating, and decanting may be a continuous operation.

Note 6 – A spray nozzle or a piece of rubber tubing attached to a water faucet may be used to rinse any of the material that may have fallen into the sieves. The velocity of the water, which may be increased by pinching the tubing, should not be sufficient to cause any splashing of the sample over the sides of the sieves.

- 7.3.3 Return all material retained on the nested sieves by flushing to the washed sample. Dry the washed aggregate to a constant mass.
- 7.3.4 Following the washing of the sample and flushing any materials retained on the 75 µm (No. 200) sieve back into the container, no water should be decanted from the container except through the 75 µm sieve, to avoid loss of material. Excess water from flushing should be evaporated from the sample in the drying process.
- 7.3.5 The individual weights of each size of the minus 4.75 mm (4 mesh) portion retained on each sieve shall be determined and recorded to the nearest 0.1 gram.
- 7.3.6 The individual portions shall be saved until the entire minus 4.75 mm (4 mesh) portion of the sample that was washed has been screened, weighed, and the weights recorded, before any of the material is discarded.

8 Sieving Procedure

- 8.1 Nest the sieves in order of decreasing size of opening from top to bottom and place the sample, or portion of the sample if it is to be sieved in more than one increment, on the top sieve. Agitate the sieves by hand or by mechanical apparatus for a sufficient period, established by trial or checked by measurement on the actual test sample, to meet the criterion for adequacy of sieving described in Section 8.3.
- 8.2 Limit the quantity of material on a given sieve so that all particles have an opportunity to reach sieve openings a number of times during the sieving operation. Table 1 shows the maximum allowable quantity of material that can be retained on each individual sieve at the completion of the sieving operation. In no case shall the quantity retained be so great as to cause permanent deformation of the sieve cloth.
 - 8.2.1 Prevent an overload of material on an individual sieve by splitting the sample into two or more portions, sieving each portion individually. Combine the masses of the several portions retained on a specific sieve before calculating the percentage of the sample on the sieve.
- 8.3 Continue sieving for a sufficient period and in such manner that, after completion, not more than 0.5 percent by mass of the total sample passes any sieve during one minute of continuous hand sieving. Perform as follows: Hold the individual sieve, provided with a snug-fitting pan and cover, in a slightly inclined position in one hand. Strike the side of sieve sharply and with an upward motion against the heel of the other hand at the rate of about 150 times per minute, turn the sieve about one sixth of a revolution at intervals of about 25 strokes. In determining sufficiency of sieving for sizes larger than the 4.75 mm (No. 4) sieve, limit the material on the sieve to a single layer of particles. If the size of the mounted testing sieves makes the described sieving motion impractical, use 203 mm (8 in.) diameter sieves to verify the sufficiency of sieving.
- 8.4 Unless a mechanical shaker is used, hand sieve particles obtained on the 75 mm (3 in) by determining the smallest sieve opening through which each particle will pass by rotating the particles, if necessary, in order to determine whether they will pass through the particular opening, however, do not force the particles to pass through an opening.
- 8.5 The efficiency of the mechanical shaker shall be checked periodically by comparing results with the hand method. This practice will help determine the length of time required for the mechanical bshaker to adequately separate material sizes.

Table 1 – Maximum Allowable Quantity of Material Retained on a Sieve, Kg (lb)

Sieve Opening Size	Nominal Dimensions of Sieve				
	8 in dia	10 in dia	12 in dia	14 x 14 in dia	16 x 24 in dia
125 mm (5 in)	a	a	a	a	67.4 (148.6)
100 mm (4 in)	a	a	a	30.6 (67.5)	53.9 (118.8)
90 mm (3 1/2 in)	a	a	15.1 (33.3)	27.6 (60.8)	48.5 (106.9)
75 mm (3 in)	a	8.6 (19.0)	12.6 (27.8)	23.0 (50.7)	40.5 (89.3)
63 mm (2 1/2 in)	a	7.2 (15.9)	10.6 (23.4)	19.3 (42.6)	34.0 (75.0)
50 mm (2 in)	3.6 (7.9)	5.7 (12.6)	8.4 (18.5)	15.3 (33.7)	27.0 (59.5)
37.5 mm (1 1/2 in)	2.7 (6.0)	4.3 (9.5)	6.3 (13.9)	11.5 (25.4)	20.2 (44.5)
25.0 mm (1 in)	1.8 (4.0)	2.9 (6.4)	4.2 (9.5)	7.7 (17.0)	13.5 (29.8)
19.0 mm (3/4 in)	1.4 (3.1)	2.2 (4.9)	3.2 (7.1)	5.8 (12.8)	10.2 (22.5)
12.5 mm (1/2 in)	0.89 (2.0)	1.4 (3.1)	2.1 (4.6)	3.8 (8.4)	6.7 (14.8)
9.5 mm (3/8 in)	0.67 (1.5)	1.1 (2.4)	1.6 (3.5)	2.9 (6.4)	5.1 (11.2)
4.75 mm (No 4)	0.33 (0.7)	0.54 (1.2)	0.80 (1.8)	1.5 (3.3)	2.6 (5.7)

a = Sieves as indicated have less than 5 full openings and should not be used for sieve testing.

9 Calculations

- 9.1 Calculate the cumulative weight passing and the percentages to the nearest 0.01 percent on the basis of the total mass of the initial dry sample.
- 9.2 *Coarse Aggregate: Plus 4.75 mm (4 Mesh) Material* – For each of the various sieves, the individual cumulative weights must be converted to total weight passing. The total weight passing is divided by the total weight of the initial dry sample multiplied by 100, which will result in the percent passing. (See the example on the following worksheets).
- 9.3 *Fine Aggregate: Minus 4.75 mm (4 Mesh) Material* - Calculating the percentages of the minus 4.75 mm (4 mesh) portion of the sample is simplified by using a reciprocal. The reciprocal is determined by dividing the percent of material passing the minus 4.75 mm (4 mesh) sieve by the weight of the minus 4.75 mm (4 mesh) sample before washing. This reciprocal, when multiplied by the various total weights passing, results in the percent passing, in relation to the total sample. (See the example on the following worksheets).

10 Report

- 10.1 Unless otherwise required, the results of the sieve analysis shall be reported as the total percentages passing each sieve size and reported to the nearest whole number for all material coarser than the 75 μ m (200 mesh) and reported to one tenth of one percent for the 75 μ m (200 mesh). Percentages shall be calculated on the basis of the total mass of the initial dry sample, including any material finer than the 75 μ m (200 mesh) sieve.

11 Hot Plant Mix Aggregates

- 11.1 Plant mix aggregates shall be governed by the provisions of MT 202, except that sampling will be in accordance with MT 201, which provides that the samples be obtained by means of an approved sampling device.

Montana Department of Transportation

Materials Lab. No. _____ UPN _____ Contract No. _____
 Dist. Lab. No. _____ Sample _____ Hole/IA# _____ Contract Item # _____
 Project No. _____
 Project Name _____
 Date Sampled _____ Date Rec. Helena _____ Kind of Deposit _____
 Sampled By _____ Witnessed by _____ Address _____
 Submitted By _____ Title _____ Date _____
 Quantity _____ Area by Stationing _____
 Area is in _____ Sec. _____ T- _____ R- _____
 Lab. No. _____ County _____
 Supplier _____ Address _____
 Sta. and/or Tons Production Sample _____ Lift No. _____
 Examined for _____

Constant Mass (500 gram sample):				Initial Wt. 524.3 grams	Check Wt. 518.6 grams	Second Check Wt. 518.6 grams
Wt. of Sample Taken	40.83 lbs.	100.00	%	LL	PL	PI
Wt. Retained 4-Mesh	26.92 lbs.	65.93	%	Wear	%	Fld. Agg. Chart No.
Wt. Passing 4-Mesh.	13.91 lbs.	34.07	%	Fracture	%	Sp.Gr. (F) [(C)
Before Wash	518.6	After	425.3	LBW	93.3	Max. Dens.
						Soil Class
						Opt. Moist
						Wt./Ft.
						Dust Ratio
						Sand Equiv.
Wt. Ret.	"	Wt Pass	Pct	Spec	Volume Swell	
					Age	Treat
					%Swell	Spec.
					Specimen Condition	
	3"					
	2½"					
	2"					
	1½"		100		"R-Value"	
3.63	1"	37.2	91		Extrude Pressure	
9.42	¾"	31.41	77		Expansion Pressure	
16.18	½"	24.65	60		Equilibrium	
20.04	⅜"	20.79	51		Micro-Deval / Sodium Sulfate	
26.92	4M	13.91	34		Micro-Deval Loss	% Sodium Sulfate Loss
146.5	8M/10M	372.1	24		Adhesion	
279.6	40M	239.0	16		% Adhesion	Bitumen Adhesive Agent
375.2	80M	143.4	9			
423.9	200M	94.7	6.2			
425.1	Pan Wt.					
0.0657	Reciprocal		0.04% is less than 0.3%			
					Checked & Approved	Date
						Name

Distribution List	
<input type="checkbox"/>	District Administrator
<input type="checkbox"/>	District Lab Supervisor
<input type="checkbox"/>	Area Lab Supervisor
<input type="checkbox"/>	Engr Project Manager
<input type="checkbox"/>	Maintenance Superintendent
<input type="checkbox"/>	Construction
<input type="checkbox"/>	Preconstruction
<input type="checkbox"/>	County File
<input type="checkbox"/>	Surfacing Design
<input type="checkbox"/>	Helena
<input type="checkbox"/>	Master Lab File
<input type="checkbox"/>	

Independent Assurance Comparison			
Sieve	Field	Dist	Helena

REMARKS: See the following page for a written explanation of calculations used for this form (F123-E).

Calculations used on form F123-E

PLUS 4.75 mm (+4 MESH) MATERIAL - The total weight passing each sieve divided by the total weight of the initial sample taken (40.83 lbs.), multiplied by 100, results in the percent passing. EXAMPLE: $13.91 \div 40.83 = 0.34 \times 100 = 34\%$ The value is rounded and recorded to the nearest whole number.

MINUS 4.75 mm (-4 MESH) MATERIAL – (By Reciprocal Method). This sample is dried to a constant mass before and after washing. A reciprocal is determined by dividing the percent of material passing the 4 mesh (34.07%) by the mass of the minus 4 mesh sample (518.6 grams). This reciprocal (0.0657) is multiplied by the cumulative weight passing for each sieve size.

EXAMPLE: $518.6 - 146.5 = 372.1$; $372.1 \times 0.0657 = 24.45\%$ and is rounded down to and is recorded as 24%. The rounding is either up or down to the nearest whole number with the exception of the 200 mesh which is carried to one tenth of a percentage (6.2%). The result represents the percent passing in relation to the total sample.

The adjusted cumulative mass retained in the pan plus the Loss By Wash (LBW) mass should be within 0.3% of original dry mass of the total sample. EXAMPLE: $425.1 + 93.3 = 518.4$, $518.6 - 518.4 = 0.2$, $(0.2/518.6) \times 100 = 0.04\%$

MONTANA DEPARTMENT OF TRANSPORTATION

Field Aggregate Chart - Sample for Clinging Fines

Project No.: _____ Contract No.: _____ Project Name: _____ Mat'ls. Suprv.: _____
 Contract Item # _____ UPN : _____ Material # : _____
 County: _____ Laboratory Pit No.: _____ Test For: _____
 Pit Location: _____ Section: _____ Township: _____ Range: _____

Test No. _____ Lot No. _____ Date _____ Stationing _____ Lift _____ Lane _____
 Sampled By _____ Tested By _____

Constant Mass	Wt. 1	Wt. 2	Wt. 3	Constant Mass	Wt. 1	Wt. 2	Wt. 3
Wt. of Sample Taken	<u>25.23</u> Lbs.		100%	Wt. of Orig. Sample Taken	<u>25.23</u> Lbs.		
Wt. Retained 4-Mesh	<u>11.59</u> Lbs.		<u>45.94</u> %	Difference in Weight			
Wt. Passing 4-Mesh	<u>13.64</u> Lbs.		<u>54.06</u> %	Passing 4 - Mesh	<u>0.39</u> Lbs.		<u>1.55</u> %
Before Wash	<u>520.5</u>	After Wash	<u>448.0</u>	LBW	<u>72.5</u>	Before Wash	<u>176.9</u>
				After Wash			LBW

Cum. Wt. Ret.	Size	Tot. Wt. Pass	Percent	Spec.	Cum. Wt. Ret.	Size	Tot. Wt. Pass	Percent	Spec.	Actual Grading % Passing	Size	% Clinging Fines
_____	4 1/2"	_____	_____	_____	_____	4 1/2"	_____	_____	_____	_____	_____	_____
_____	4"	_____	_____	_____	_____	4"	_____	_____	_____	_____	4 1/2"	_____
_____	3 1/2"	_____	_____	_____	_____	3 1/2"	_____	_____	_____	_____	4"	_____
_____	3"	_____	_____	_____	_____	3"	_____	_____	_____	_____	3 1/2"	_____
_____	2 1/2"	_____	_____	_____	_____	2 1/2"	_____	_____	_____	_____	3"	_____
_____	2"	_____	_____	_____	_____	2"	_____	_____	_____	_____	2 1/2"	_____
_____	1 1/2"	_____	_____	_____	_____	1 1/2"	_____	_____	_____	_____	2"	_____
_____	1 1/4"	_____	_____	_____	_____	1 1/4"	_____	_____	_____	_____	1 1/2"	_____
_____	1"	_____	_____	_____	_____	1"	_____	_____	_____	_____	1 1/4"	_____
<u>0</u>	5/8 3/4"	<u>25.23</u>	<u>100</u>	_____	<u>0</u>	5/8 3/4"	<u>25.23</u>	<u>100</u>	_____	_____	1"	_____
<u>1.29 lbs</u>	1/2"	<u>23.94</u>	<u>94.89</u>	_____	<u>1.22 lbs</u>	1/2"	<u>24.01</u>	<u>95.16</u>	_____	<u>100</u>	5/8 3/4"	<u>0</u>
<u>4.69 lbs</u>	3/8"	<u>20.54</u>	<u>81.41</u>	_____	<u>4.43 lbs</u>	3/8"	<u>20.80</u>	<u>82.44</u>	_____	<u>95.16</u>	1/2"	<u>0.27</u>
<u>* 11.59 lbs</u>	4 M	<u>13.64</u>	<u>54.06</u>	_____	<u>* 11.20 lbs</u>	4 M	<u>14.03</u>	<u>55.61</u>	_____	<u>82.44</u>	3/8"	<u>1.03</u>
<u>219.7 g</u>	8/10 M	<u>300.8</u>	<u>31.25</u>	_____	<u>19.9 g</u>	8/10 M	<u>157.0</u>	<u>1.38</u>	_____	<u>55.61</u>	4 M	<u>1.55</u>
<u>375.8 g</u>	40 M	<u>144.7</u>	<u>15.03</u>	_____	<u>48.4 g</u>	40 M	<u>128.5</u>	<u>1.13</u>	_____	<u>32.63</u>	8/10 M	_____
<u>420.5 g</u>	80 M	<u>100.0</u>	<u>10.39</u>	_____	<u>90.0 g</u>	80 M	<u>86.9</u>	<u>0.76</u>	_____	<u>16.16</u>	40 M	_____
<u>447.9 g</u>	200 M	<u>72.6</u>	<u>7.54</u>	_____	<u>174.9 g</u>	200 M	<u>2.0</u>	<u>0.02</u>	_____	<u>11.15</u>	80 M	_____
_____	Pan/Total	_____	_____	_____	_____	Pan/Total	_____	_____	_____	<u>7.56</u>	200 M	_____
_____	Reciprocal	<u>0.1039</u>	_____	_____	_____	Reciprocal	<u>0.0088</u>	_____	_____	_____	Pan/Total	_____
_____		_____	_____	_____	_____		_____	_____	_____	_____	Reciprocal	_____

* ±4 Mesh Sample Split and Sieved

Dust Ratio _____%	Dust Ratio _____%
Moisture _____%	Moisture _____%
Fracture _____%	Fracture _____%
Liquid Limit _____	Liquid Limit _____
Plasticity Index _____	Plasticity Index _____

NOTE: Report the % Clinging Fines to the tenth, 1.6%

Dust Ratio _____%
 Moisture _____%
 Fracture _____%
 Liquid Limit _____
 Plasticity Index _____

Checked by _____ Date _____ Entered by _____ Date _____

REMARKS: See the following page for a written explanation of calculations used for this form (F104C-E).

Calculations used on form F104C-E

PLUS 4.75 mm (+4 MESH) MATERIAL - The total weight passing each sieve divided by the total weight of the initial sample taken (25.23 lbs.), multiplied by 100, results in the percent passing. EXAMPLE: $13.64 \div 25.23 = 0.5406 \times 100 = 54.06\%$

MINUS 4.75 mm (-4 MESH) MATERIAL – (By Reciprocal Method). This sample is dried to a constant mass before and after washing. A reciprocal is determined by dividing the percent of material passing the 4 mesh (54.06%) by the mass of the minus 4 mesh sample (520.5 grams). This reciprocal (0.1039) is multiplied by the cumulative weight passing for each sieve size. EXAMPLE: $520.5 - 219.7 = 300.8$; $300.8 \times 0.1039 = 31.25\%$ and is rounded down to and is recorded as 31%. The rounding is either up or down to the nearest whole number with the exception of the 200 mesh which is carried to one tenth of a percentage (7.5%). The result represents the percent passing in relation to the total sample.

For the Actual Grading % Passing of the +4 MESH, use the second gradation.

To calculate the % of Clinging Fines on each sieve (change in percentage), take the percent from the +4 MESH of the second gradation and subtract the percent from the +4 MESH of the first gradation. EXAMPLE $95.16 - 94.89 = 0.27\%$

In order to calculate the Actual Grading % Passing the MINUS 4.75 mm (-4 MESH), the percent passing in the second gradation is added to the percent passing the first gradation. EXAMPLE: $31.25 + 1.38 = 32.63$

The reciprocal for the second sieve analysis is calculated by taking the % of clinging fines on the +4 MESH and dividing it by the before wash weight of the second gradation. EXAMPLE: $1.55 \div 176.9 = 0.0088$

The adjusted cumulative mass retained in the pan plus the Loss By Wash (LBW) mass should be within 0.3% of original dry mass of the total sample. EXAMPLE: $447.9 + 72.5 = 520.4$, $520.5 - 520.4 = 0.1$, $(0.1 / 520.5) \times 100 = 0.02\%$

METHODS OF SAMPLING AND TESTING
MT 207-04
CENTERLINE SOIL SURVEY

1 Introduction

- 1.1 A centerline soil survey is an essential part of preliminary highway engineering. Information on the engineering properties and distribution of soils, rock and groundwater must be obtained before a reasonable and economic highway design can be developed. A soil survey is not intended to take the place of a thorough Geotechnical Foundation investigation.
- 1.2 The soil survey work depends on many factors which include scope of the proposed project, types and variability of materials found on the project, groundwater conditions, adverse geologic features, etc. Often field conditions found during the soil survey will increase or decrease the amount of work needed to supply the necessary information for design. The soil survey and the geotechnical investigation must be coordinated in order to preclude duplication of effort.

2 Referenced Documents**AASHTO**

M 145 Classification of Soils and Soil-Aggregate Mixtures for Highway Construction Purposes
 T 190 Resistance R-Value and Expansion Pressure of Compacted Soils

MT Materials Manual

MT 210 Moisture-Density Relations of Soils Using a 5.5 lb. Rammer
 MT 230 Moisture-Density Relations of Soils Using a 10 lb. Rammer

3 Apparatus

- 3.1 *Sampling tools*
 Hand shovels, picks, etc.
 Hand augers, post hole diggers
 Power augers and drills, etc.
 Backhoes
- 3.2 *Instruments*
 Survey equipment
 Nuclear moisture and density testing device
 Camera & film
- 3.3 *Miscellaneous*
 Stakes and lath
 Sample bags (17"X28" canvas 75 lb. capacity cloth)
 Sealed containers (jars or plastic bags)
 Field notebooks and forms

4 General Procedure

- 4.1 *General Procedure:* Following is the general procedure which should be followed in conducting any soil survey. The complexity of the soil survey will depend upon many factors as discussed in Section 1.2 above.
- 4.2 Reconnaissance of the proposed project should be conducted with pertinent existing information in hand. Additional information available may include but is not limited to the following items:
- Maintenance records
 Construction records
 Topographic & geologic maps
 Historic use of the area
 U.S. Department of Agriculture Soil Conservation Service
 County soil survey reports
 Utility company maps & locations

City and county plat maps
 City, county and state health department information
 Information from landowners and businesses
 Aerial photography

4.3 *Preliminary Survey Plan*

- 4.3.1 A preliminary plan should be determined prior to fieldwork. This should be based upon available information and intended scope. Approximate sample site locations should be determined to enable proper soil profile determination and adequate sampling. This plan will likely change as information is gained during the actual construction of the test sites.
- 4.3.2 Boring records should be kept in a systematic manner and referred to new centerline stationing and elevations for each project. Such records should include and be recorded on Forms 30 and 111.

Describe each site or area investigated, with each test hole, boring, or test pit clearly located (horizontally and vertically) with reference to some established coordinate system or permanent monument.

Log each test hole, boring, test pit, or cut-surface exposure with the field description and location of each material encountered clearly shown by Montana Department of Highways' symbols and word descriptions used on Form 30.

Note – Color photographs of samples, and exposed strata may be of considerable value to the Department. Each photograph should include a date and an identifying number or symbol.

Identify all soils based on AASHTO M 145 Classification of Soils and Soil-Aggregate Mixtures for Highway Construction Purpose.

Record seepage and water-bearing zones and free water-table depth found in each test hole, boring or test pit.

Identify artifacts and items of cultural and historical significance.

Note items concerning environmental hazards or other worthy notes.

- 4.3.3 Identify vertical and/or horizontal change of original ground where instability problems exist (landslides, subsidence, etc.).

4.4 *Soil Profile Determination and Sampling*

- 4.4.1 Boring or test pits should be taken for laboratory analysis from all areas which may supply appreciable quantities of earthwork, and known borrow areas. Embankment areas should be tested for areas of swamp conditions or loosely compacted soils that will result in embankment settlements. The spacing of these investigations will depend upon the geologic complexity of the project area and upon the importance of soil and rock parameters to the project design. The depth should be a minimum of five feet below the proposed top of subgrade elevation or to borrow area depth.

4.5 *Sampling*

- 4.5.1 Accurately identify each sample with the project identification, location, date, test site number and depth below reference ground surface from which it was taken. Place identification inside the container, securely close the container, protect it to withstand rough handling, and mark it with proper identification on the outside of the container. Keep samples for natural moisture determination in sealed containers to prevent moisture loss. When drying of samples may affect classification or engineering properties, protect them to minimize moisture loss.

- 4.5.2 Soil and water samples should be taken from the probable, proposed, or existing centerline of pipe, channel bottom and bridge locations as well as probable borrow areas, to determine pH, resistivity and sulfate (SO₄) content of the soil and water. In areas of bad soils (resistivity less than 500), additional samples should be taken.

Sample Size not less than 5 lbs. (2.3 Kg.)

Sample Size, Water 1 quart.

- 4.5.3 Evaluate performance of existing installations in the immediate vicinity of the proposed site, relative to their historical performance and environmental impact. Photos of relevant installations properly labeled are helpful.

- 4.5.4 Representative disturbed samples for laboratory classification tests of soil, rock, and local construction material should be supplemented by undisturbed specimens.

- 4.5.5 Standard traffic control is required while working on the PTW.

4.6 *Testing*

- 4.6.1 Testing analysis should be performed on all samples for the following items and recorded on Form 111.

Soil class by AASHTO M 145

Liquid limit

Plastic limit

Percent of material passing the 10 mesh, 40 mesh, and 200 mesh sieve size.

Maximum dry density and optimum moisture content by MT 230 for A-1 soils, MT 210 for all other soils

In-place density and moisture content

"R" value by AASHTO T 190, all soils except A-6 and A-7's.

Depth to water table

5 **Field Procedure**

5.1 *Overlay, New and Reconstruction Projects*

Survey data required for all projects is as follows:

The PTW should be cored at least 5' into the subgrade and sampled in the driving lanes (not the shoulder) as frequently as necessary.

Typical sampling frequency is one per 1/2 mile, more or less as conditions dictate.

Note and log the mat thickness.

Note and log base thickness and subgrade. Sample and determine moisture content, record soil class (AASHTO M 145), moisture, density and "R" value (AASHTO T 190).

Perform a culvert inspection; take chemical corrosion samples where necessary. Take photos at locations of bad pipe.

Review the existing project and record its past performance. A narrative summary should be provided with the soil survey.

Problem areas must be shown and recommendations for sub-excavation and the proposed depth of sub-excavation should be noted.

Anticipated borrow material should be sampled and tested for R values and corrosion.

Projects, where the intent is to overlay the existing plant mix, should be cored and the cores submitted to the Materials Bureau for evaluation. A typical sampling frequency is one (1) core per lane mile with a minimum of five (5) cores per project. The frequency can and should be adjusted as conditions warrant. The cores will be evaluated to determine the in-place condition of the PMS and a report issued to Surfacing Design.

5.2 *New and Reconstruction Projects Only*

Additional survey data for new and reconstruction projects only are as follows:

Review planning reports and anticipate alignment and grades.

Test holes in the field should be located to provide engineering soil properties where appreciable quantities of excavation will occur. Depth will be determined by the new grade line with holes extending about five feet below the proposed subgrade line. Typical sampling frequency is one per 1/2 mile, more or less as conditions dictate.

Tests should include samples of each soil strata encountered and the in place moisture, the chemical-corrosive properties, soil class (AASHTO M 145), "R" value (AASHTO T 190), and the specific gravity for each strata.

Determine in place densities for shrink and swell determinations if frozen conditions do not exist.

A log of the test holes should be kept and the test holes plotted on a profile sheet.

Data obtained should be reviewed to determine if additional test sites (i.e., areas of refusal, inadequate depth, or of questionable frequencies) are required.

Topsoil depth and availability should be noted.

Any anticipated borrow material should be sampled for "R" value, chemical-corrosive properties, and moisture density purposes.

If centerline is following close to the PTW and material in present embankment will be used, additional R-values and chemical-corrosive properties should be taken beneath the PTW driving lanes.

Potential borrow areas that have better quality soils (A-4(0) or better) should be investigated to determine their use in the top 2' of the subgrade especially in areas where surfacing materials are scarce.

6 Interpretation of Results

6.1 Interpret the results of an investigation only in terms of actual findings and make every effort to collect and include all field and laboratory data from previous investigations in the same areas. Extrapolation of data into local areas not surveyed and tested can be done only where geologically uniform subsurface conditions of soil and rock are known to exist. Engineering properties of the soils and rocks encountered on important projects should not be predicted wholly on field identifications or classification but should be checked by laboratory and field tests made on samples collected.

6.2 The recommendations for design parameters can be made only by professionals who have specialized in the field of soils and foundations or highway engineering, and who are familiar with the problems for which the study is being made.

7 Report

7.1 A soil survey investigation report should:

- 7.1.1 Locate the area investigated in terms pertinent to the project. This may include sketch maps or aerial photos on which the test holes, pits, and sample areas are located, as well as topographic items relevant to the determination of the various soil and rock types, such as contours, streambeds, sink holes, cliffs, etc. Where feasible, include a geologic map of the area investigated in the report.
- 7.1.2 Include copies of all borings, test-hole logs and laboratory test results.
- 7.1.3 Describe and relate the findings obtained by following the format of Section 4, General Procedure.
- 7.1.4 Provide preliminary shrink/swell recommendations. Shrink/swell information obtained from adjacent projects in the area should be included.
- 7.1.5 Provide recommendations relative to availability of better quality soils (A-4(0) or better) that could be used in the top 2' of the subgrade to reduce more costly surfacing material and to improve drainage.

Provide recommendations for additional testing required by core drill, seismic, etc., for materials inaccessible because of depth, topography, etc.

7.1.6 Each soil survey shall be submitted and distributed as follows:

- 1 copy to Preconstruction Bureau
- 1 copy to Geotechnical & Materials Bureau
- 1 copy to Surfacing Design - Materials Bureau
- 2 copies to be retained by the District

**DRAINAGE EVALUATION FORM
MT 207**

This form should be submitted with each soil survey. Each area of concern on the project should be noted.

Project No. _____ Designation: _____

Date _____ Submitted by: _____

Station(s) _____

Are the ditch lines clear of standing water? _____

Are the ditch lines and pavement edges free from weed growth that may indicate a moisture concentration? _____

After a rain,

a) Is there moisture standing in the joints or cracks? _____

b) Is there any evidence of pumping? _____

c) Is there water standing at the outer edge of the shoulder? _____

d) Is there evidence that the water may pond on the shoulder? _____

Are joint sealants or crack sealants in good condition and preventing water from entering the pavement? _____

Are the cross drainage conduits closed by debris? _____

AC Pavements

Is there moisture related distress evident such as; Stripping, Rutting, Cracking in Wheelpath, Shoulder Dropoff/Heave, Pumping, Water Bleeding, Swelling?

PCC Pavements

Is there moisture related distress evident such as; Pumping, Faulting, Corner Break, D-Cracking, Edge Joint Opening, Shoulder Dropoff/Heave, Punchout (CRCP only), Swelling, Slab Cracking?

Is there evidence of springs and excessively wet areas? _____

Are there slides or slumps noted along the alignment? _____

Specific surface/subsurface drainage recommendations _____

MT 207

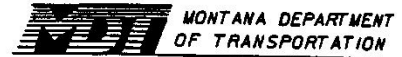

LOG OF BORING

Geotechnical Section

Project Name: **EXAMPLE - ENGLISH** Project Number: **BR 549(0)**

Borehole Location: **STA. 13+95, 20.8 ft. Lt. PTW Centerline** Borehole Number: **EXAMPLE** Sheet **1** of **1**

Drilling Equipment: **CME 550** Hammer Type: **Automatic** Driller: **A. Driller** Logger: **A. Logger**

Drilling Fluid: **Water** Borehole Diameter (in): **8** Date Started: **1/1/98** Date Finished: **1/1/98**

Elevation and Datum: **Ground: 3739.80** Casing: _____ Notes: **Legal Description - 01S18E32DAC. Elevation and Station provided by District Survey.**

DEPTH (feet)	DRILL										MATERIAL DESCRIPTION	DEPTH (feet)	REMARKS		
	OPERATION	PRESSURE (psf)	RATE (fph)	CORE PERCENT RECOVERY	ROCK QUALITY DESIGNATION (ROD)	SAMPLE RECOVERY (%)	STANDARD PENETRATION TEST	DRY DENSITY (pcf)	MOISTURE CONTENT (%)	LIQUID LIMIT				PLASTIC LIMIT	GRAPHIC LOG
0															
5						100	5-10-5	15		NP					
10						100		100	30	53	18				
12						85	3-4-3	27							
15						100	37-50/0.4 ft.								
16	500	15	100	85											
20	700	20	100	88											
25															

Bottom of Hole Elevation = 3714.80 ft.

GPJ_MTD01.GDT 3/25/98

Operation Types: Auger Casing Advancer Core Barrel Drive Casing	Sampler Types: Split Spoon Shelby Bulk Sample Grab Sample	Penetrometer Vane Shear Special Samplers Testpit
--	--	---

WATER LEVEL OBSERVATIONS

While Drilling ∇ 12.1 ft Upon Completion of Drilling ∇ 9.8 ft

Time After Drilling _____

Depth To Water (feet) _____

Remarks: Water table at 9.8 ft.

LOG OF BORING



MT 207

MONTANA DEPARTMENT OF TRANSPORTATION

Geotechnical Section

Project Name: SAMPLE - Metric				Project Number: _____											
Borehole Location: _____				Borehole Number: -		Sheet 1 of 1									
Drilling Equipment: _____				Hammer Type: _____		Driller: _____									
Drilling Fluid: _____				Borehole Diameter (mm): _____		Date Started: _____									
Elevation and Datum: Ground: _____ Casing: _____				Notes: _____											
DEPTH (m)	DRILL		CORE PERCENT RECOVERY	ROCK QUALITY DESIGNATION (RQD)	SAMPLE	RECOVERY (%)	STANDARD PENETRATION TEST	DRY DENSITY (kN/m ³)	MOISTURE CONTENT (%)	LIQUID LIMIT	PLASTIC LIMIT	GRAPHIC LOG	MATERIAL DESCRIPTION	DEPTH (m)	REMARKS
	OPERATION	PRESSURE (MPa)													
2															
4															
6															
8															
10															

LOG OF BORING BLANK-M GPJ MTDOT.GDT 1/13/98

Operation Types:

- Auger
- Casing Advancer
- Core Barrel
- Drive Casing

Sampler Types:

- Split Spoon
- Shelby
- Bulk Sample
- Grab Sample

Penetrometer

- Vane Shear
- Special Samplers
- Testpit

WATER LEVEL OBSERVATIONS

While Drilling ∇ _____ m Upon Completion of Drilling ∇ _____ m

Time After Drilling _____

Depth To Water (m) _____

Remarks: _____

METHODS OF SAMPLING AND TESTING
MT 210-16
METHOD OF TEST FOR THE MOISTURE-DENSITY RELATIONS OF SOILS
USING A 5.5 LB. (2.5 KG) RAMMER AND A 12 IN. (305 MM) DROP
(Modified AASHTO T 99)

MT 210 is identical to AASHTO T 99 except for the following stipulations:

1. Replace Section 1.5 with the following:

If the specified oversized particle maximum percentage is exceeded (except for material that meets the criteria described in MT 218, Section 4.6.), the replacement method should be used. The replacement method maintains the same percentage of coarse material (passing a 50 mm sieve and retained on a 4.75 mm sieve) in the moisture-density sample as in the original field sample. The material retained on the 19.0 mm sieve shall be replaced as follows: sieve an adequate quantity of the representative soil over the 50 mm and 19.0 mm sieve. Weigh the material retained on the 19.0 mm sieve. Replace this material with an equal mass of material passing the 19.0 mm sieve and retained on the 4.75 mm sieve. Take the material for replacement from the extra portion of the sample.

METHODS OF SAMPLING AND TESTING
MT 212-18
DETERMINATION OF MOISTURE AND DENSITY OF IN-PLACE MATERIALS
(Modified AASHTO T 310 and T 355)

1 Scope

- 1.1 This test method describes the procedures for determining the moisture and/or density of in-place materials, either in the natural state or after compaction, by the use of nuclear density/moisture gauge.
- 1.2 Alternatively, moisture may be determined in the laboratory by AASHTO T 265, Laboratory Determination of Moisture Content of Soils.

2 Referenced Documents**AASHTO**

- T 265 Laboratory Determination of Moisture Content of Soils
 T 310 In-Place Density and Moisture Content of Soil and Soil-Aggregate by Nuclear Methods
 T 355 In-Place Density of Asphalt Mixtures by Nuclear Methods

MT Materials Manual

- MT 210 Moisture-Density Relations of Soils Using A 5.5 Lb Rammer and a 12 In Drop
 MT 230 Moisture-Density Relations of Soils Using A 10 Lb Rammer and a 18 In Drop

3 Apparatus

- 3.1 *Nuclear moisture/density gauge* containing radioactive sources, electronics and rechargeable batteries
- 3.2 *Standard Count Reference Block*
- 3.3 *AC Charger 115v/60Hz and DC Adapter 12v negative ground*
- 3.4 *Transport case* designed and labeled for each specific gauge
- 3.5 *Scraper Plate/Drill Rod Guide*
- 3.6 *Drill Rod and Drill Rod Extractor*
- 3.7 *Operators Manual and Gauge Booklet*
- 3.8 *Sieve, 30 mesh* for seating sand
- 3.9 *Thermoluminescent Dosimeter (TLD) Badge*

4 Calibration

The nuclear moisture/density gauges are calibrated by the MDT Materials Bureau for testing density of PCC and AC pavements. The gauges are also calibrated for both density and moisture of most soils and soil aggregate mixtures. The calibrations are stored electronically within the gauge.

5 Operational Considerations

- 5.1 A manufacturer's instructional manual is furnished with each nuclear device and must be consulted for operational procedures. These procedures vary between gauges and must be followed carefully.
- 5.2 Nuclear gauges shall **only be distributed** to personnel who have received the required 8 hour radiation safety and nuclear gauge operation course.

- 5.2.1 Gauge operators must attend a 2 to 4 hour refresher course at intervals not to exceed three (3) years. This training will be provided by MDT.
- 5.2.2 District Materials Supervisors must ensure that each gauge operator has completed an approved operator training course, that their card is up to date and in their possession, and that a radiation monitoring device (TLD Badge) is properly utilized when handling nuclear gauges.
- 5.3 Gauge operators should be very familiar with the Operator's Instruction Manual.
- 5.4 Gauge operators should always be aware of battery charge status and follow battery care instructions in Operator's Manual.
- 5.5 The gauge electronics must be turned on to warm up for a minimum of 15 minutes before taking the daily standard count or testing. Leave the power on all day during testing.
- 5.6 The Nuclear Gauge Transport form shall be kept with the nuclear gauge at all times. When transporting a gauge, the certification shall be filled out, visible and within reach of the driver.
- 5.7 Additional Operational Considerations and Radiation Safety are provided in the Appendix.

6 Standardization

- 6.1 Standard counts shall be taken and recorded each day that gauges are put into use and should be taken in the same environment as the actual measurement counts (i.e., at the construction site). The standardization should be performed with the gauge at least 10 m (30 ft) away from other nuclear density/moisture gauges and clear of large masses of water or other items that may affect the reference count rates.
- 6.2 If the daily standard counts are more than 1% for density or 2% for moisture from the average of the previous four counts, procedures should be thoroughly examined and the counts taken again. If these counts also fail, problems with the gauge or procedure are indicated and the appropriate District or Area Laboratory should be contacted.

7 Stability Test

- 7.1 A Stability Test should be performed whenever the accuracy of the gauge is in doubt.
- 7.2 A Stability Test consists of 20, one-minute Standard Counts.
- 7.3 Calculations (Using Actual Gauge Readings)
 - 7.3.1 Determine the Average Reading (*AVG*)

$$AVG = \frac{\sum_{i=1}^N X}{N}$$

Where:
 AVG = Average
 X = Reading
 N = number of readings

7.3.2 Calculate the Standard Deviation (SD)

$$SD = \sqrt{\frac{\sum_1^N (X - AVG)^2}{N}}$$

Where:

SD = Standard Deviation

X = Reading

N = number of readings

7.3.3 Calculate the Stability Ratio

$$Stability\ Ratio = \frac{SD}{\sqrt{AVG}}$$

7.4 If the ratio falls outside of the indicated ranges, procedures should be checked and the stability test taken again. If another failure occurs, contact the appropriate District or Area Lab.

PASSING RATIOS	
<i>Moisture</i>	<i>Density</i>
0.18-0.35	0.18-0.35

8 Procedure

8.1 Soil and Soil-Aggregate (Direct Transmission Method)

8.1.1 Follow AASHTO T 310 Sections 9.1 – 9.3 and 9.5, collecting at least two (2) readings. Rotate the gauge 90 or 180 degrees, pivoting it around the source rod. The final result will be the average of all the readings.

8.2 Asphalt Mixtures

8.2.1 Follow AASHTO T 355 Section 9

9 Calculations

9.1 Use the appropriate [Compaction Form](#) for recording field determinations with Nuclear Devices.

9.2 Wet density, dry density, and moisture can be read directly from the gauge scales in pounds per cubic foot (lb/ft³). Percent moisture can also be read directly from the gauge.

9.3 Percent Compaction Calculation

$$\% \text{ Compaction} = \frac{\text{Field Dry Density } \left(\frac{\text{lb}}{\text{ft}^3}\right)}{\text{Proctor Dry Density}} \times 100$$

Note 1 – Proctor Dry Density from MT 210 or MT 230.

9.4 Compare field moisture to optimum moisture from the Proctor determination.

9.5 Record percent moisture and density readings to the nearest whole percent.

APPENDIX

A.1 Radiation Safety

- A.1.1 Each nuclear gauge operator must wear a TLD badge attached to the front of his/her clothing or belt at waist level. The District Materials Supervisors issue these badges.

Note 2 – A TLD badge is a device that monitors a person's potential exposure to radiation.

- A.1.1.1 These TLD badges must not be transferred from one operator to another.

- A.1.1.2 When not in use, TLD badges should be stored at least 30 feet from nuclear gauges, out of direct sunlight, and away from excessive heat or dampness. **Badges left near gauges are especially susceptible to unfounded high readings.**

- A.1.1.3 Whenever a TLD badge has a high reading, the individual to whom the badge was issued will be notified and must fill out a report and submit it to the Materials Bureau within five days. It is important that all facts and details be presented accurately and conscientiously including diagrams, distances and times. Statements from supervisors and witnesses are also valuable.

- A.1.1.4 The District Materials Supervisor will keep an up-to-date record consisting of the individual's name, the date the badge was issued, the serial number of the gauge they are using, and the project to which the gauge is assigned. This information, along with the TLD badges will be mailed to the Materials Bureau within ten days after the end of the quarter.

- A.1.2 The leak testing of all nuclear gauges will be performed by personnel in the Materials Bureau or other individuals designated by the Radiation Safety Officer to perform such tests. An up-to-date record of the results of these tests shall also be maintained by the Materials Bureau.

A.2 Transportation

- A.2.1 The nuclear gauges require careful handling. The vehicle in which they are transported should be capable of keeping them dry and provide complete security from unauthorized personnel. It should also be equipped with a carrying rack to which the instrument cases can be strapped and locked.

A.3 Storage

- A.3.1 Storage areas should be locked and posted with radiation caution signs.

- A.3.2 When the equipment is not being used, it should be stored in a separate dry room or garage. The temperature in the storage area should be above freezing and the batteries in the device should be fully charged. Never store a device in an area where personnel are working or will be working. Radiation caution signs shall be posted at the entrance door of any storage area.

- A.3.3 Radiation levels surrounding the storage area shall not exceed two (2) millirems per hour. To help ensure low radiation levels outside the storage area, a gauge should be stored as near the center of the room as practical. Gauges should not be stored above, below or adjacent to a work area. The best way to assure radiation safety is to limit the number of gauges in a storage area. The largest number of gauges to be stored in one area is determined by the outside radiation level which shall not exceed 2 millirems per hour. The Materials Bureau in Helena will check the outside area to see if the radiation levels are acceptable.

- A.3.4 Store the gauge fully charged. Battery charging during storage is not necessary but gauges should be given a full charge prior to initial use at the beginning of the construction season.

A.4 Maintenance

- A.4.1 The Materials Bureau should be notified immediately when any breakdowns occur. It will be decided at that time whether the gauge should be sent to the Materials Bureau for repairs.

- A.4.2 Clean and maintain the gauge regularly as recommended in the Operator's Manual.

METHODS OF SAMPLING AND TESTING
MT 216-13
METHOD OF SAMPLING AND TESTING CEMENT TREATED BASE
(Montana Test Method)

1 Scope

- 1.1 This method describes procedures for making, curing, and testing cylindrical specimens from representative samples of Cement Treated Base (CTB).

2 Referenced Documents**AASHTO**

- T 19 Bulk Density ("Unit Weight") and Voids in Aggregate
 T 134 Moisture-Density Relations of Soil-Cement Mixtures
 T 231 Capping Cylindrical Concrete Specimens

ASTM

- D1633 Standard Test Method for Compressive Strength of Molded Soil-Cement Cylinders

MT Materials Manual

- MT 201 Sampling Roadway Materials
 MT 212 Determination of Moisture and Density of In-Place Materials
 MT 228 Method of Establishing Field Target Density for Cement Treated Base Density Control
 MT 405 Wire Cloth Sieves for Testing Purposes
 MT 601 Materials Sampling, Testing and Acceptance Guide

3 Apparatus

- 3.1 *Molds* - Use solid-wall, metal cylinders manufactured with dimensions and capacities shown in 3.1.1. They must have a detachable collar assembly approximately 2.375 in. (60 mm) in height, to permit preparation of compacted specimens of soil-cement mixtures of the desired weight and volume. The mold and collar assembly must be constructed so that it can be fastened firmly to a detachable base plate made of the same material.

Note 1 – Alternate types of molds with capacities as stipulated herein may be used, provided the test results are correlated with those of the solid-wall mold on several soil types and the same moisture-density results are obtained. Records of such correlations shall be maintained and readily available for inspection when alternate types of molds are used.

- 3.1.1 A 4 in. (101.6 mm) mold having a capacity of $1/30 \pm 0.0003$ cu. ft. (943 ± 8 cm³) with an internal diameter of 4.000 ± 0.016 in. (101.6 ± 0.41 mm) and a height of 4.584 ± 0.005 in. (116.43 ± 0.13 mm).

- 3.1.2 *Molds Out of Tolerance Due to Use* - A mold that fails to meet manufacturing tolerances after continued service may remain in use provided those tolerances are not exceeded by more than 50 percent; and the volume of the mold, calibrated in accordance with AASHTO T 19, Section 8 (Calibration of Measure), is used in the calculations.

3.2 *Rammer*

- 3.2.1 *Manually Operated* - Metal rammer having a flat circular face of 2.000 in. (50.8 mm) diameter, a manufacturing tolerance of ± 0.01 (0.25 mm) and weighing 5.50 ± 0.02 lb. (2.495 ± 0.009 kg). The in-service diameter of the flat circular face shall be not less than 1.985 in. (50.42 mm). Use a rammer equipped with a suitable guide-sleeve to control the height of drop to a free fall of 12.00 ± 0.06 in. (305 ± 2 mm) above the elevation of the soil. The guide-sleeve must have at least 4 vent holes, no smaller than $3/8$ in. (9.5 mm) diameter spaced approximately 90 degrees (1.57 radius) apart and approximately $3/4$ in. (19 mm) from each end, and provide sufficient clearance so the free fall of the rammer shaft and head is unrestricted.

- 3.2.2 *Mechanically Operated* - A metal rammer equipped with a device to control the height of drop to a free fall of 12.00 ± 0.06 in. (305 ± 2 mm) above the elevation of the soil and uniformly distributes such drops to the soil surface (Note 2). The rammer must have a flat circular face 2.000 in. (50.8 mm) diameter, a manufacturing tolerance of ± 0.01 (0.25 mm) and weighing 5.50 ± 0.02 lb. (2.495 ± 0.009 kg).

Note 2 – Calibrate the rammer apparatus with several soil-cement mixtures. Adjust the mass of the rammer, if necessary, to give the same moisture-density results as with the manually operated rammer. It may be impractical to adjust the mechanical apparatus so the free fall is 12 in. (305 mm) each time the rammer is dropped, as with the manually operated rammer. To make the adjustment of free fall, the portion of loose soil to receive the initial blow should be slightly compressed with the rammer to establish the point of impact from which the 12 in. (305 mm) drop is determined. Subsequent blows on the layer of soil-cement may all be applied by dropping the rammer from a height of 12 in. (305 mm) above the initial-setting elevation, or when the mechanical apparatus is designed with a height adjustment for each blow, all subsequent blows should have a rammer free fall of 12 in. (305 mm) measured from the elevation of the soil-cement as compacted by the previous blow.

- 3.2.3 *Rammer Face* – Use the circular face rammer. If necessary, use a sector face rammer as an alternative. Indicate the type of face used other than the 2 in. (50.8 mm) circular face in the report. The alternate must have an area equal to that of the circular face rammer.

- 3.3 *Sample Extruder* - A jack, lever, frame, or other device adopted for the purpose of extruding compacted specimens from the mold.

- 3.4 *Balances and Scales* - A balance or scale of at least 25 lb. (11.5 kg) capacity having sensitivity and readability to 0.01 lb. (5 grams). Also, a balance of at least 3 lb. (1 kg) capacity having sensitivity and readability to 0.003 oz. (0.1 gram). Use balances or scales of the same units shown in the contract.

- 3.5 *Heat Source* - Oven, hot plate or alternate heating source.

- 3.6 *Straightedge* - A hardened steel straightedge at least 10 in. (254 mm) in length. Use a straightedge with one beveled edge. At least one longitudinal surface (used for final trimming) must be plane within 0.01 in. per 10 in. (0.25 mm per 250 mm) (0.1 percent) of length within the portion used for trimming the soil. (Note 3)

Note 3 – The beveled edge may be used for final trimming if the edge is true within a tolerance of 0.01 in. per 10 in. (0.25 mm per 250 mm) (0.1 percent) of length; however, with continued use, the cutting edge may become excessively worn and not suitable for trimming the soil to the level of the mold. The straightedge should not be so flexible that trimming the soil surface with the cutting edge will concave the soil surface.

- 3.7 *Sieves* – 2 in. (50 mm), $\frac{3}{4}$ in. (19.0 mm), No. 4 (4.75 mm) sieves conforming to the requirements of [MT 405](#).

- 3.8 *Mixing Tools* – Miscellaneous tools such as mixing pan, spoon, trowel, spatula, etc., or a suitable mechanical device for thoroughly mixing the sample of soil with increments of water.

- 3.9 *Container* – A flat, round pan for moisture absorption by soil-cement mixtures about 12 in. (305 mm) in diameter and 2 in. (50 mm) deep.

- 3.10 *Moisture Containers* - Suitable containers made of material resistant to corrosion and not subject to change in weight or disintegration on repeated heating and cooling. Use containers with close-fitting lids to prevent loss of moisture from samples before initial weighing and to prevent absorption of moisture from the atmosphere following drying and before final weighing. One container is needed for each moisture content determination.

- 3.11 *Butcher Knife* - A butcher knife approximately 10 in. (250 mm) in length, for trimming the top of the specimens.

4 CTB Mix Design

- 4.1 Verify that the contractor has submitted a cement treated base mix design to the Materials Bureau at least 10 business days before scheduled placement. Confirm with the Materials Bureau that the design is approved for use before allowing placement on the project.

5 Acceptance

- 5.1 *In-Place Densities* – Test for compaction in accordance with Specifications 304.03.5. Determine in-place densities in accordance with [MT 212](#). Establish a corrected moisture curve by correcting the nuclear moisture reading to oven-dry moisture contents.
- 5.2 *Field-Made Compression Specimens* – Mold a minimum of one set of compressive strength specimens for every 750 cubic yards (575 cubic meters) of CTB in accordance with [MT 601](#). A set consists of three compressive strength specimens molded in accordance with Section 6 of this procedure. It is desirable that these specimens represent the material placed at the locations of the in-place densities so moisture-density comparisons can be made. Two specimens from each set will be tested at 7 days to determine strength acceptance. The remaining specimens will be broken at 28 days to identify strength gain. A copy of the sample record containing moisture content, cementitious material content, and density must accompany each set of compressive strength specimens in the shipping boxes.
- 5.3 *Acceptance Samples of Aggregate* - Sample for gradation analysis in accordance with Specification 304.03.1.

6 Molding Specimens in the Field

- 6.1 Sample the CTB mixture placed on the roadway from a representative location in accordance with [MT 201](#). Obtain approximately one cubic foot of material and place in suitable container(s) lined with a plastic bag. Once the sample is complete, close the bag and place a lid on the container(s). This is done to reduce any possibility of moisture loss from the sample. Transport the sample to the place of molding as quickly as possible in order to minimize hydration (excessive hydration can reduce the lubrication properties and result in less than maximum density and therefore lower strengths). Remix the sample before and during molding to ensure uniformity and prevent segregation.
- 6.2 Immediately form a specimen by compacting the mixture in the mold in accordance with AASHTO T 134, Section 5.5 (with the collar attached). Trim the specimen in accordance with AASHTO T 134, Section 5.6. Uniformly distribute the material by spading along the inside of the mold with a spatula for each lift placed in the mold and before compaction. After compaction of each lift, scarify or roughen the top of the layer in order to obtain a good bond between lifts.
- 6.3 During compaction, obtain a representative sample of the mixture, weighing not less than 500 grams. Weigh the sample immediately and dry until further drying does not alter the weight greater than 0.1 percent, constant mass. Determine the moisture content as a check against design moisture content.
- 6.4 Weigh the compacted specimen to check against design density before beginning the initial cure. (Note 4)

Note 4 – Once the specimen has been struck off to the required smoothness and weighed, cover the top of the mold with plastic and place the compaction collar back on the mold, leaving the plastic in place. Tighten the collar so that the plastic will make an airtight seal around the rim of the mold and the surface of the specimen. This is done to prevent moisture loss from the specimen during the initial cure. Once all specimens have been molded and sealed with plastic, place in a cure box to protect the specimens from temperature extremes and from direct sunlight. Maintain a temperature range of 60° F to 80° F during the initial cure in the field. The location for the initial cure must be horizontally level, rigid, and free from vibration or other disturbances.

- 6.5 Maintain a running average of densities and moistures in accordance with [MT 228](#) to establish density control.
- 6.6 Form two additional specimens in the same manner as the first as rapidly as possible. Identify two specimens as 7-day compression specimens, and the third as a 28-day compression specimen. (Note 5)

Note 5 – A satisfactory method of identifying the specimens for the 7-day or 28-day breaks is to wrap a piece of masking tape around the specimen. Indicate on the masking tape the date made, stationing & lane, type of test, etc.

- 6.7 Cure the compacted specimens in the molds a minimum of 24 hours. Extract the specimens from the molds, place in the shipping box packed in damp sawdust, and transport to the Materials Bureau as soon as possible so that the final cure can be accomplished in the moist cure room for the remainder of the curing period.

7 Compressive Strength Determination

- 7.1 Determine the diameter using two diameter measurements to the nearest 0.01 inches (0.25 mm) taken at 90 degrees to one another near mid height of the specimen. Prior to placing compressive strength specimens in the compression machine, verify that both ends of the specimen are plane to within 0.002 in (0.05 mm). If an end of the specimen is outside of the 0.002 in. (0.05 mm) tolerance, cap that end of the specimen in accordance with AASHTO T 231.
- 7.2 Determine the 7 day unconfined compressive strength in accordance with ASTM D1633 except as modified herein. Omit the requirement for immersing cured specimens in water for 4 hours prior to testing.
- 7.3 Maintain free moisture on the outsides of specimens to prevent drying until testing is complete (except for the ends of the specimens when sulfur capping). When capping with sulfur, be certain that the ends of the specimen are dry enough to prevent small pockets of steam from forming within the capping compound.

8 Calculation

- 8.1 Calculate the unit compressive strength of the specimen by dividing the maximum load by the cross-sectional area.

$$S = \frac{lbf}{\pi r^2}$$

Where:

S = Strength

lbf = Maximum Load

r = Radius of Specimen

- 8.2 For purposes of this method, determine strength of specimens using a height (uncapped) divided by diameter ratio of 1.15. This is standard and is not to be corrected by a length to diameter correction factor.

9 Report

- 9.1 The field technician is to report the following:
Sample Date the cylinder was made
Percent cement rounded to the nearest tenth
Percent fly ash rounded to the nearest tenth
Depth of material placed rounded to the nearest tenth of a ft (m)
Station where sample was taken
Density rounded to the nearest tenth of lbs per ft³ (kg per m³)
Moisture content rounded to the nearest tenth of a percent
- 9.2 The lab technician is to report the following:
Date the cylinder was broken
Diameter of the cylinder rounded to the nearest hundredth of an inch (mm)
Load rounded to the whole number in lbs per ft (kg per m)
Compressive strength rounded to the nearest whole number in lbs per in² (MPa)

Report the average strength of the two 7-day cylinders rounded to the nearest whole number.

METHODS OF SAMPLING AND TESTING
MT 218-04
METHOD OF TEST FOR
DETERMINING RELATIVE COMPACTION AND PERCENT MOISTURE
(*Montana Test Method*)

1 Scope

- 1.1 This procedure is intended as a guide for comparing in-place moisture and density to optimum moisture and maximum density, respectively, in order to determine compliance with standard specifications and contract special provisions.

2 Referenced Documents

MT Materials Manual

MT 210 Moisture-Density Relations of Soils Using a 5.5 lb. Rammer
MT 212 Determination of Moisture and Density of In-Place Materials
MT 230 Moisture-Density Relations of Soils Using a 10 lb. Rammer

3 In-Place Moisture and Density

- 3.1 The in-place moisture and density shall be determined in accordance with MT 212.

4 Optimum Moisture and Maximum Density

- 4.1 The optimum moisture and maximum density shall be determined in accordance with MT 210 or MT 230, Method A, B, C, or D, whichever is applicable, using the following criteria as a guide.
- 4.2 When the material under test is a soil or aggregate consisting of entirely minus 4 mesh (4.75 mm), Method A or B will be used.
- 4.3 When the material under test is a soil or aggregate with a maximum size of 3/4 inch (19.0 mm), Method C or D will be used.
- 4.4 When the material under test is a soil or aggregate with a maximum size of 2 inches (50 mm), Method D will be used.
- 4.5 When the material under test is a soil or aggregate with a maximum size of 4 inches (100 mm) and no more than 50% of the material under test is retained on the 4 mesh (4.75 mm), Method D will be used.
- 4.6 When the material under test is a soil or aggregate with a maximum size larger than 2 inches (50 mm) and more than 50% of the material under test is retained on the 4 mesh (4.75 mm), the material will not be required to meet 95% density within 2% optimum moisture.
- 4.6.1 A screen analysis must be provided on representative samples from each lift of the embankment area to prove that more than 50% of the material is retained on the 4 mesh (4.75 mm) sieve.
- 4.6.2 Nuclear moisture and/or density readings ([MT 212](#)) must be taken on each lift in the embankment area to demonstrate that uniform relative density has been achieved. Report percent moisture and density reading to the nearest whole percent.
- 4.6.3 Notes must be made on the [Summary of Compaction Data \(Form 1006\)](#) showing the results obtained in paragraphs 4.6.1 and 4.6.2.

5 Calculation

- 5.1 Determine the relative compaction by dividing the in-place density (pounds per cubic foot) by the maximum density (pounds per cubic foot) and multiplying by 100.
- 5.2 A direct comparison of the in-place moisture and the optimum moisture will determine compliance with specifications.

6 Family of Curves

- 6.1 A "family of curves" is a term applied to a number of moisture-density curves which are plotted on one cross-section sheet, using the same ordinates and abscissas as dry weights pounds per cubic foot and moisture contents, respectively. The family of curves is plotted, initially, from values obtained by the sampling and testing of the various soil types during the Preconstruction Soils Survey and every effort must be made to sample and identify all of the various soil types that will be encountered on the project. Each new soil type, or mixture of soils, encountered on the project during construction, will be represented by a moisture-density curve, which is added to the "family".

Note 1 – New curves drawn through plotted one-point determinations shall not become a permanent part of the family of curves until verified by a full moisture-density relationship.

7 One Point Proctors

- 7.1 A "one point Proctor" is an abbreviated standard Proctor compaction test and is used in conjunction with the family of curves. Rather than determining the moisture and density points for an entire curve, a single point is determined for the purpose of selecting the curve, which represents the soil being compacted, from the family of curves.
- 7.1.1 One-point Proctors shall be run whenever there is any doubt that the soil being compacted is from a location on the project, which is represented, by one of the curves in the family of curves.
- 7.1.2 Frequently soils may be mixed by heavy equipment excavating and hauling to the embankment site and a one-point Proctor may not fit any of the established curves. In these cases a new curve will have to be prepared from the mixture and added to the family of curves.
- 7.1.3 It is necessary to run the one-point Proctor as close to optimum moisture as possible. The point should be within plus or minus three percent of optimum on most curves and within plus or minus two percent of optimum on sharp breaking curves. If the point is established on either side of optimum and some distance from the peak of the curve, it may very well fit more than one curve in the family of curves, or none at all and it will be impossible to select the proper curve.
- 7.1.4 The moisture and density results obtained by the one-point Proctor are plotted on the family of curves and, when obtained near optimum, will fall near one of the curves in the family of curves, provided that particular type of soil or mixture of soils has been tested for optimum moisture and maximum density. The peak of the curve selected shall be considered the optimum moisture and maximum density of the material represented by the one-point Proctor.

Note 2 – If the one-point plotted within or on the family of curves does not fall in the 80 to 100 percent of optimum moisture range, compact another specimen, using the same material, at an adjusted moisture content that will place the one-point within this range.

8 Numbering Check Samples

When a check sample is taken it will be assigned the same number as the sample being checked, with the addition of a letter suffix. For example, if sample number 38 failed to meet specifications, the first check sample would be numbered 38-A, the second check sample would be 38-B.

METHODS OF SAMPLING AND TESTING
MT 219-19
METHOD OF TEST FOR CONTROLLING COMPACTION
USING A CONTROL-STRIP TEST SECTION WITH NUCLEAR GAUGES
(Montana Test Method)

1 Scope

- 1.1 This test method is intended to control the density of compacted courses of embankment and borrow containing oversized particles and/or recycled asphalt pavement (RAP), pulverized bituminous surfacing, and cold recycled bituminous surfacing using nuclear gauges. Density control is performed in place after compaction. Cold recycled bituminous surfacing may be produced in-place or off-site in a central plant.

2 Referenced Documents

MT Materials Manual

MT 212 Determination of Moisture and Density of In-Place Materials

MT 230 Moisture-Density Relations of Soils using a 10 lb. Rammer

MT 321 Determining Theoretical Maximum Specific Gravity of Bituminous Paving Mixtures –
"Rice Gravity"

3 Definitions

- 3.1 *Control-Strip A - Embankment, Borrow, or Pulverized Bituminous Surfacing* – A section approximately three hundred (300) feet long by the typical section width of two lanes on a firm sub-grade.
- 3.2 *Control-Strip B - Cold Recycled Bituminous Surfacing* – A section approximately three hundred (300) feet long by one paver width on a firmly compacted base.
- 3.3 *Test Section - Embankment, Borrow, or Pulverized Bituminous Surfacing* - Individual sections each approximately two thousand (2000) feet long, as constructed, on which the surfacing aggregates will be placed, using the same layer thickness, compaction watering, and procedures used in constructing the Control-Strip A above.
- 3.4 *Test Section - Cold Recycled Bituminous Surfacing* – Individual sections each approximately two thousand (2000) feet long by one paver width on which Cold Recycled Bituminous Surfacing will be placed, using the same layer thickness, compaction and procedure used in construction the Control-Strip B above.
- 3.5 *Constant Mass* – Constant mass has been reached when there is less than a 0.1 percent change in mass after additional drying time: for an oven at $110 \pm 5^\circ \text{C}$ ($230 \pm 9^\circ \text{F}$), an additional 30 minutes of drying; for an uncontrolled heating source such as hot plates, an additional 20 minutes of drying; or for microwaves, an additional 10 minutes of drying.

4 Apparatus

- 4.1 *Nuclear moisture/density gauge* containing radioactive sources, electronics and rechargeable batteries
- 4.2 *Standard Count Reference Block*
- 4.3 *AC Charger 115v/60Hz and DC Adapter 12v negative ground*
- 4.4 *Transport case* designed and labeled for each specific gauge
- 4.5 *Scraper Plate/Drill Rod Guide*

4.6 *Drill Rod and Drill Rod Extractor*4.7 *Nuclear Gauge Operators Manual and Gauge Booklet***5 Operational Procedures**5.1 *Control-Strip A - Embankment, Borrow, or Pulverized Bituminous Surfacing*

At the beginning of compaction operations, the density requirements shall be determined by compacting a Control-Strip of an approved thickness. The procedure MT 230 (Proctor Test) establishes the dry density for aggregates being used in the Control-Strip (Note 1).

Note 1 – The moisture and density of the Control-Strip will be determined by approved nuclear equipment under field conditions.

5.1.1 After each application of the roller, wet density and moisture determinations are made with the nuclear device at a minimum of three (3) random locations. Density and moisture determinations for aggregate surfacing are to be taken at the appropriate depth relative to lift thickness using the “direct transmission” option with the nuclear gauge. These locations may be marked with a small quantity of minus 30 mesh dry sand - the finer the better. This sand should be screened from the material that is being compacted and dried to constant mass. This sand serves to identify each test location and is an aid for seating the nuclear device to preclude air voids between the bottom surface of the probe and the coarser aggregate particles that may be extruding above the surface of the lift. To avoid any errors in reading due to the build-up of sand beneath the nuclear device, approximately the same quantity of sand is used at each of the three test locations. The test locations are marked so that the same locations are tested after each pass.

5.1.2 An average dry density is computed and plotted on a chart of dry density versus the number of roller passes. Rolling is discontinued when the curve plotted for dry density versus roller passes levels off. When the density plot levels off, density and moisture readings are taken at seven additional locations. Ten test sites in the 300 feet long Control-Strip are calculated to yield satisfactory statistical results. The average dry density is computed from the ten sets of readings and this serves as the standard of compaction. A new Control-Strip is required when the aggregate characteristics change appreciably, the aggregate is produced from a different source, or there has been a change in the rolling equipment or procedures used. Each new lift will require a new Control-Strip to determine if there is any change in Control-Strip density. If a different nuclear device is used, a new Control-Strip might have to be established.

5.2 *Test Sections for Embankment, Borrow, or Pulverized Bituminous Surfacing*

The remainder of the project is divided into Test Sections as described above in Section 3.3. After placing and compacting a lift of surfacing aggregate, employing the same thickness and procedures used in the Control-Strip, moisture and density readings are taken at ten randomly selected locations. Dry density determinations are made for each set of readings.

5.2.1 Whenever the minimum density results are not met, immediate corrective action must be taken by additional rolling or additional water and rolling. The densities of the completed Test Sections must be determined without delay for applicable comparison (under the same conditions) with the Control-Strip density (Note 2). Similarly, proper use of the most suitable roller can decrease time in attaining proper density in the Test Section. The contractor should be encouraged to use various methods in establishing density in the Control-Strip.

Note 2 – (Not a specification requirement) The effective use of water and the method used in compacting the Control-Strip can influence the time and the compactive effort required to attain satisfactory density. Appropriate compaction equipment for the material should be used at all times.

5.3 *Control-Strip B - Cold Recycled Bituminous Surfacing*

All roller equipment will be approved by the engineer prior to the construction of the Control-Strip as specified in the Standard Specification. Whenever a Control-Strip is required on cold recycled bituminous surfacing a comparison will be made between the established Control-Strip density

and the Maximum Mixture Specific Gravity (Rice Gravity) as determined by MT 321. This should be done to ensure a reasonable Control-Strip density is established and is in line with the specified compaction percentage.

- 5.3.1 Three test sites will be randomly selected on the Control-Strip. Each site will be marked with minus 30 mesh dry seating sand used to seat the nuclear gauge. This sand should be screened from the material that is being compacted and dried to constant mass. Compaction of the Control-Strip shall commence as soon as possible after cold recycling of the mixture and be uniform over the entire Control-Strip. A test will be taken on each test site with a nuclear gauge after each pass of the compaction equipment. Density determinations for cold recycled bituminous surfacing are to be taken using the "backscatter" option with the nuclear gauge. When testing cold recycled bituminous surfacing in backscatter mode, consult the nuclear gauge operator's manual to determine if "Asphalt mode" should be enabled.
- 5.3.2 This procedure will continue until the density increase is less than one (1) pound per cubic foot. After completion of the rolling, then two more tests sites are established so that a total of five density tests are averaged for the Control-Strip density.
- 5.3.3 Each new lift will require a new Control-Strip to determine if there is any change in Control-Strip density. If a different nuclear device is used, a new Control-Strip must be established.

5.4 *Test Sections for Cold Recycled Bituminous Surfacing*

The remainder of the project is divided into 2000 ft. Test Sections. After placing and compacting a lift of cold recycled bituminous surfacing, employing the same thickness and procedures used in the Control-Strip, density readings are taken at five randomly selected locations. The average density of each Test Section will be evaluated based upon the results of five tests in each Test Section. Whenever the minimum density results are not met, immediate corrective action must be taken by additional rolling or re-recycling. The densities of the completed Test Sections must be determined without delay for applicable comparison (under the same conditions) with the Control-Strip density.

6 Forms and Reports

- 6.1 Use Lab Form No. 1000A for controlling the compaction of surfacing aggregates. This form may also be used for Control-Strip paving.
- 6.2 Lab. Form No. 1006-A, Summary of Compaction Data for Surfacing, is applicable for all types of nuclear devices. It is requested that the serial number of the device being used and the Laboratory Number of each pit, be entered on this form.

METHODS OF SAMPLING AND TESTING
MT 226-16
MAXIMUM ACCEPTABLE DEVIATIONS
IN THE SIEVE ANALYSIS OF INDEPENDENT ASSURANCE SAMPLES
(Montana Method)

1 Scope

- 1.1 This method shall serve as a guide in evaluating the maximum acceptable deviations in the sieve analysis of **Independent Assurance** samples. If the individual grading percentages vary from the group average percentages by more than the amounts listed, the cause must be determined and the error remedied. Deviation percentages are based on the weight of the total sample.

2 References***MT Materials Manual***

MT 201 Sampling Roadway Materials

MT 602 Independent Assurance and Final Record Sampling

MT 607 Procedure for Reducing Field Samples of Aggregate to Testing Size

Sieve Size	Permissible Variation
4" (100 mm)	±3%
3" (75 mm)	±3%
2 1/2" (63 mm)	±3%
2" (50 mm)	±3%
1 1/2" (37.5 mm)	±3%
1" (25 mm)	±3%
¾" (19 mm)	±3%
5/8" (16.0 mm)	±3%
½" (12.5 mm)	±3%
3/8" (9.5 mm)	±3%
No. 4 (4.75 mm)	±2%
No. 8 (2.36 mm)	±2%
No. 10 (2.00 mm)	±2%
No. 16 (1.18 mm)	±2%
No. 30 (0.600 μm)	±2%
No. 50 (0.300 μm)	±2%
No. 100 (0.150 μm)	±2%
No. 200 (0.075 μm)	±1.5

METHODS OF SAMPLING AND TESTING
MT 228-13
METHOD OF ESTABLISHING FIELD TARGET DENSITY FOR
CEMENT TREATED BASE DENSITY CONTROL

1 Scope

- 1.1 This method is the procedure for establishing the field target density and moisture for compaction control of cement treated base (CTB).

2 Referenced Documents

AASHTO

T 134 Moisture-Density Relations of Soil-Cement Mixtures

MT Materials Manual

MT 216 Method of Sampling and Testing Cement Treated Base

3 Procedure

- 3.1 At the start of CTB production, use the maximum density and optimum moisture determined by AASHTO T 134 and provided in the mix design as the target for compaction control.
- 3.2 When samples for MT 216 have been taken, use the specimens molded for compressive strength to determine density. Use the average density of the three specimens to represent each sample. Use additional material taken for MT 216 to determine moisture content. Once the field density and moisture have been determined for two samples, average the results. If the average results in an increase of 1.0 pounds per cubic foot (16.0 kg per cubic meter) or greater or a decrease of 1.5 pounds per cubic foot (24.0 kg per cubic meter) or greater, calculate a new maximum density and optimum moisture in accordance with AASHTO T 134 for the material produced. Apply the new maximum density retroactive to the start of CTB production on the project. Do not change the target moisture unless a new optimum moisture is determined by AASHTO T 134.
- 3.3 When field densities on four samples have been completed, average the four test values. If the average results in an increase of 0.5 pound per cubic foot (8.0 kg per cubic meter) or greater or a decrease of 1.0 pound per cubic foot (16.0 kg per cubic meter) or greater, calculate a new maximum density and optimum moisture in accordance with AASHTO T 134 for the material produced. Apply the new maximum density to all subsequent CTB produced. Do not change the target moisture unless a new optimum moisture is determined by AASHTO T 134.
- 3.4 As each additional field density and moisture is completed, add the results to the results of the previous three densities and moistures, and average. If the average results in an increase of 0.5 pound per cubic foot (8.0 kg per cubic meter) or greater or a decrease of 1.0 pound per cubic foot (16.0 kg per cubic meter) or greater, calculate a new maximum density and optimum moisture in accordance with AASHTO T 134 for the material produced. Apply the new maximum density to all subsequent CTB produced. Do not change the target moisture unless a new optimum moisture is determined by AASHTO T 134.

METHOD OF SAMPLING AND TESTING
MT 229-15
PROCEDURE FOR SOLIDS - WATER - VOIDS RELATIONS
OF SOIL MASSES (ZERO-AIR VOIDS)

1 Scope

- 1.1 This method covers the compaction of soils by using the solids-water-voids (zero-air voids) chart. This method usually applies to the north central, eastern and southeastern areas of Montana but may apply to other areas of the state. It will be the responsibility of the District Materials Supervisor to monitor the applicability of this method.

2 Referenced Documents

AASHTO

T 100 Specific Gravity of Soils

MT Materials Manual

MT 210 Moisture Density Relations of Soils Using a 5.5 Lb. Rammer and a 12 Inch Drop

MT 230 Moisture Density Relations of Soils Using a 10 Lb. Rammer and a 18 Inch Drop

3 Procedure

- 3.1 Air voids are another method used to determine the compaction of soils. The zero-air voids method will usually apply to soils classified from A-4 to A-7. When the zero-air voids method is not applicable, the 95% of maximum density and $\pm 2\%$ of optimum moisture will be used.
- 3.2 In order for this method to be accurate, it is necessary to find the specific gravity for the soils proposed for use. The most logical time to determine the specific gravity is during the pre-construction soil survey. However, due to the excavation process, which may result in a mixture of various soil strata, it may become necessary to perform additional specific gravity tests once the project is under contract. The specific gravity of soils is determined in accordance with AASHTO T 100. (An average specific gravity is determined for the soil samples secured within any individual project.)
- 3.3 Individual proctor tests determined during the pre-construction soil survey are plotted on the zero-air voids chart. If the plot of the peaks from the family of proctor curves from the preliminary soil survey falls on a line roughly parallel to the zero-air voids, the zero-air voids method should work. Tests that fall to the left of the 10% air voids line are generally single size granular particle soils or excessively wet condition type soils. With these soils, the 95% of maximum density and $\pm 2\%$ of optimum moisture will be used.
- 3.4 Tests taken in the field that lie outside, or to the right of the 0% air voids line, not within the band, should be reviewed and treated as a failing test or possibly a bad reading by the density gauge. However, it is unusual to get tests that fall to the right of the 0% line. If tests consistently fall to the right of the 0% line, a specific gravity on the soil in question should be determined in accordance with AASHTO T100. Special Provision covers Proctor tests that plot outside the zero-air voids chart under compaction control. All proctor tests must be plotted on a zero-air voids chart to see if each test fits the zero-air voids chart.

4 Calculations

4.1 Formula for calculating % voids:

$$\% \text{ Voids} = 100 - \left(\left[\frac{d(1 + [G_s(m/100)])}{(G_s)(W)} \right] \times 100 \right)$$

where:

US Standard

d = Dry Density in lb/ft³

G_s = Specific Gravity

m = % moisture

W = wt of water in lb/ft³ or 62.42796

Metric

d = Dry Density in Kg/m³

G_s = Specific Gravity

m = % moisture

W = wt of water in Kg/m³ or 1000

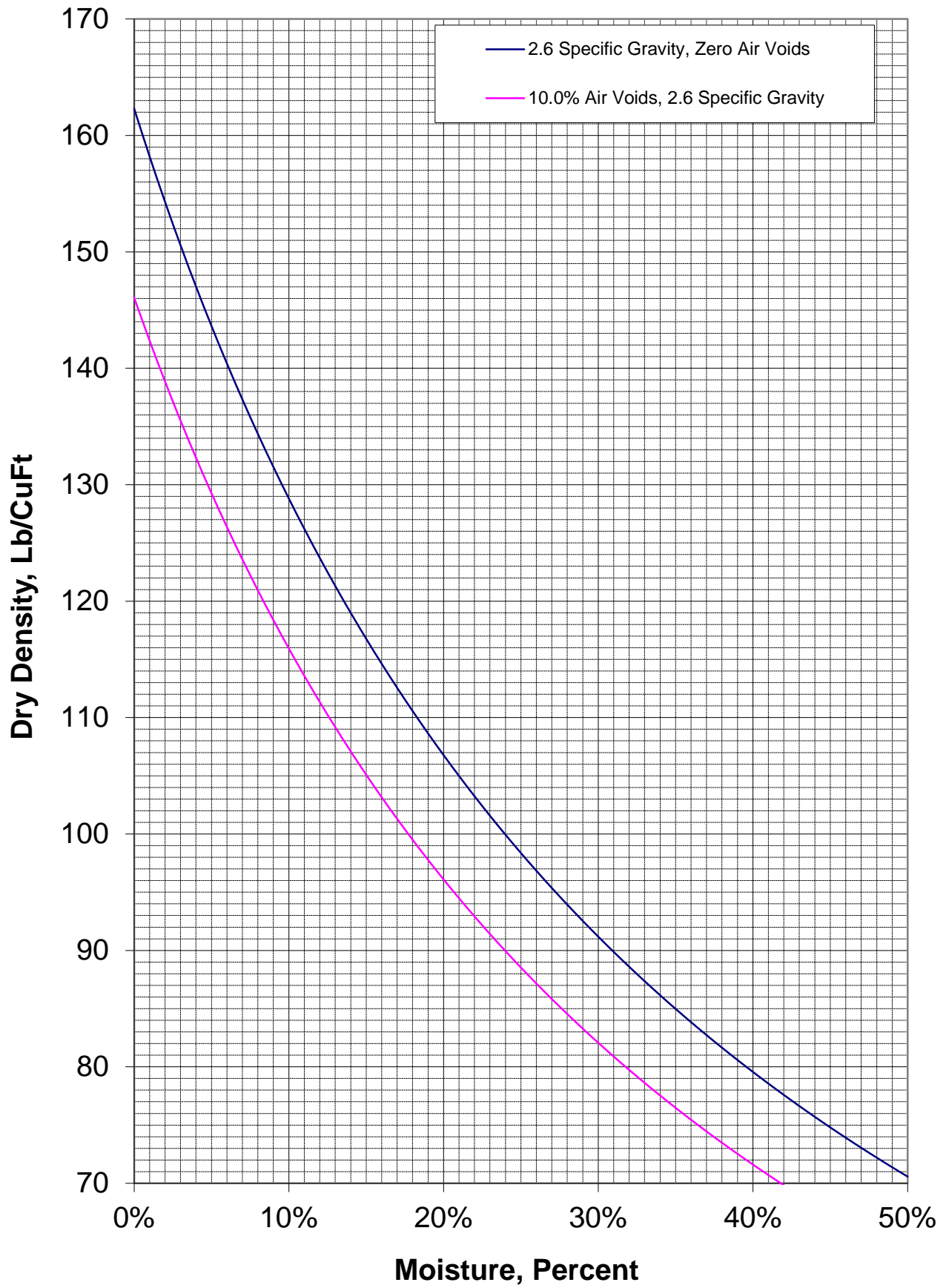

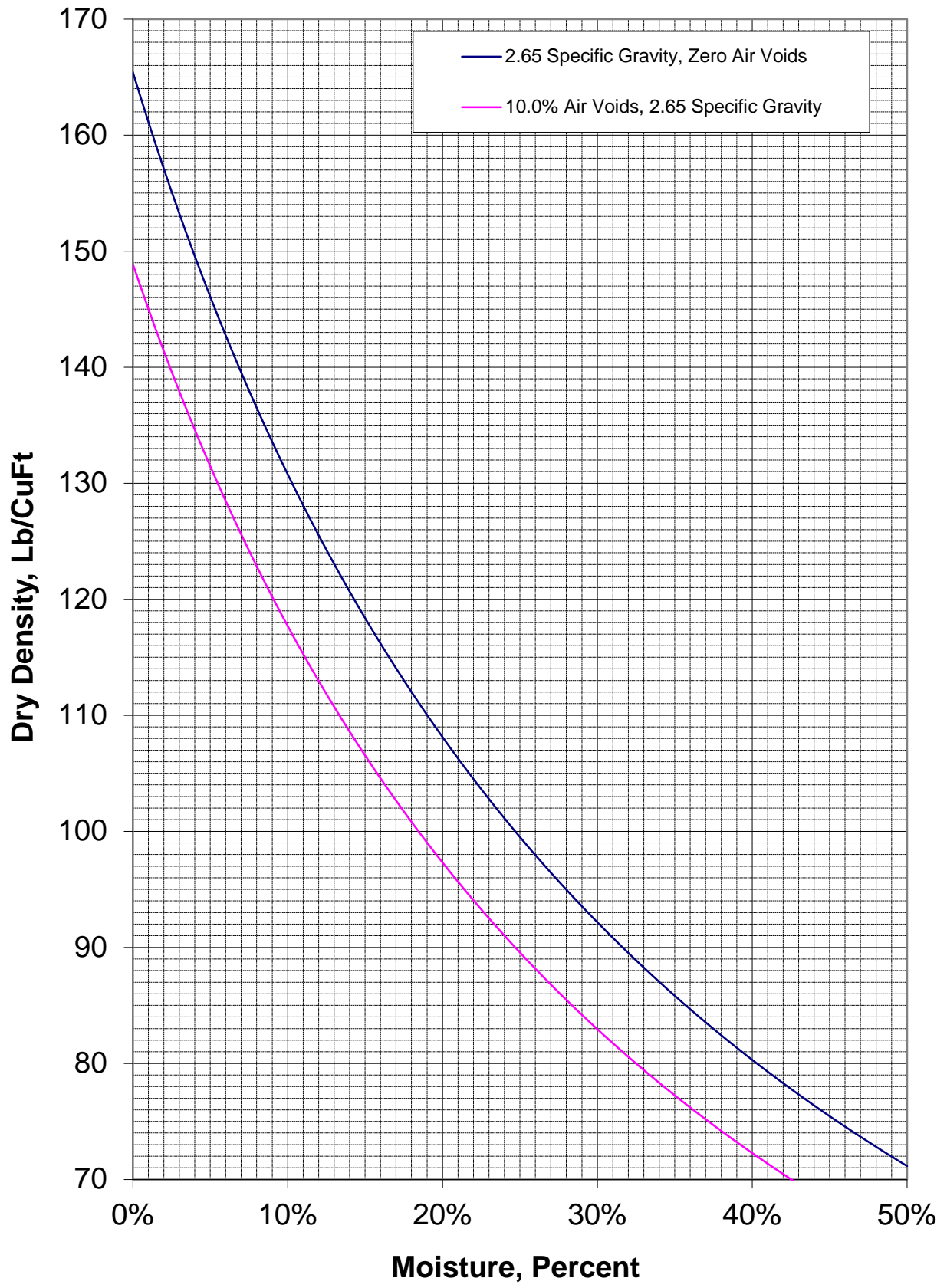

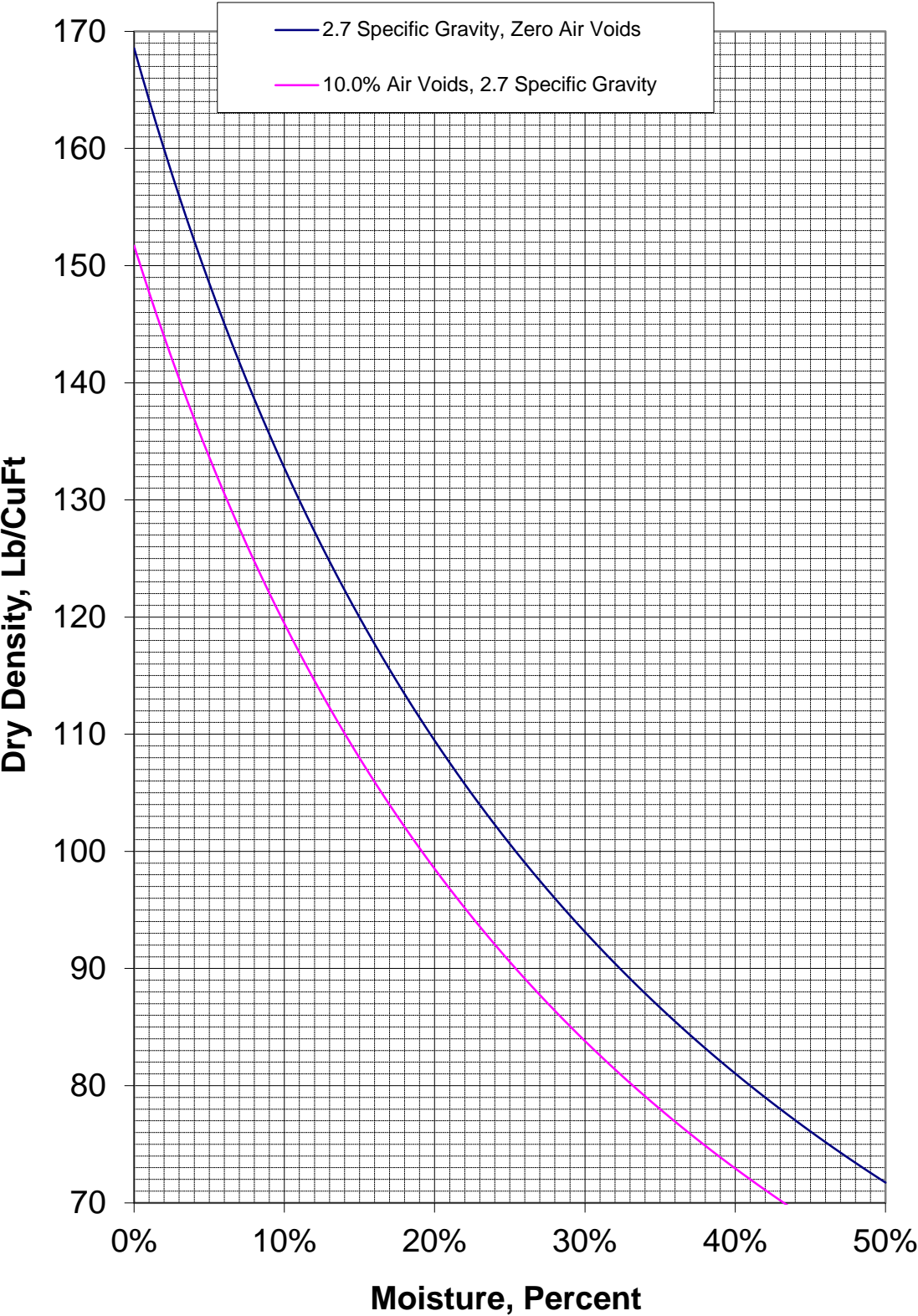

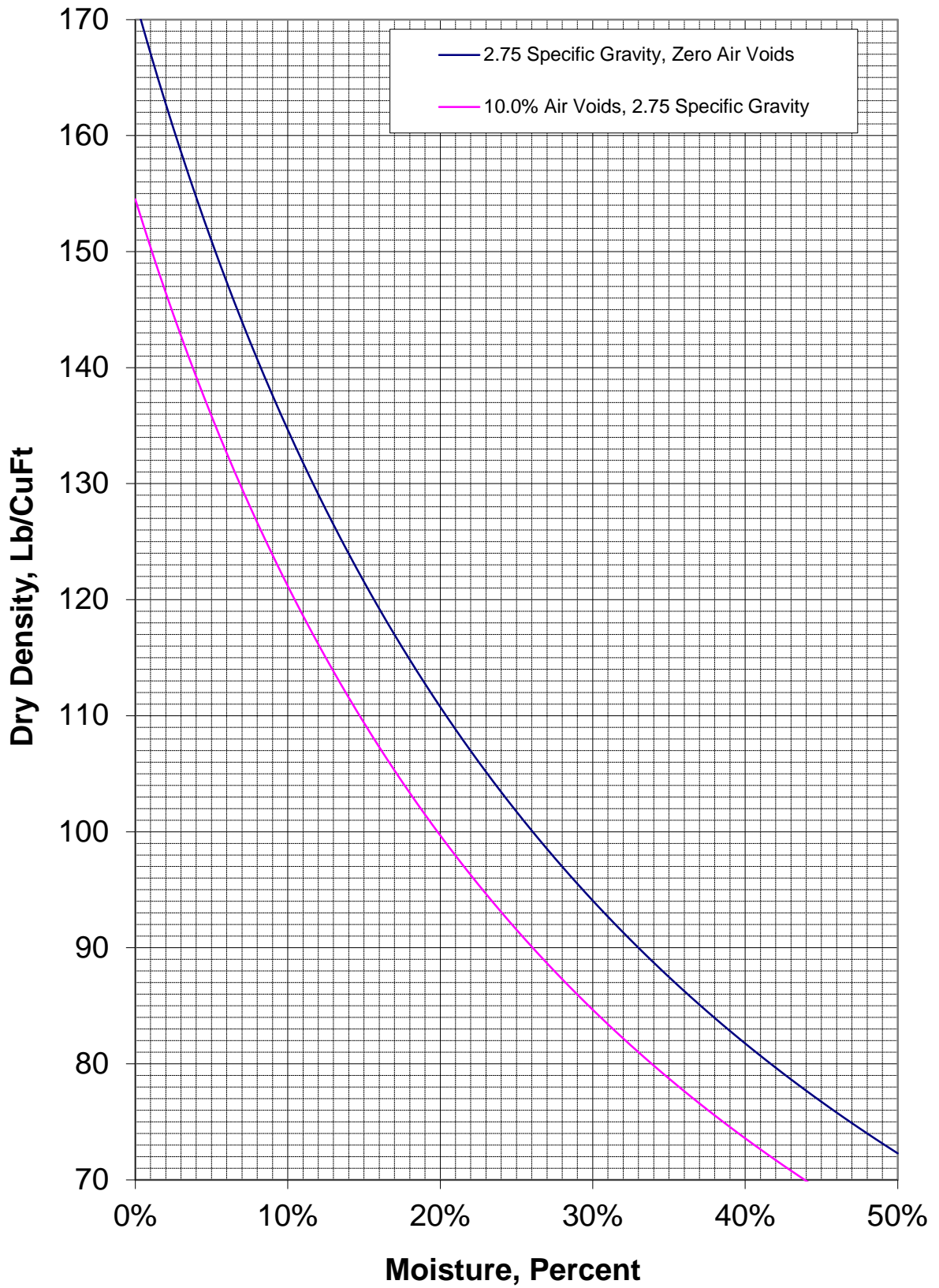

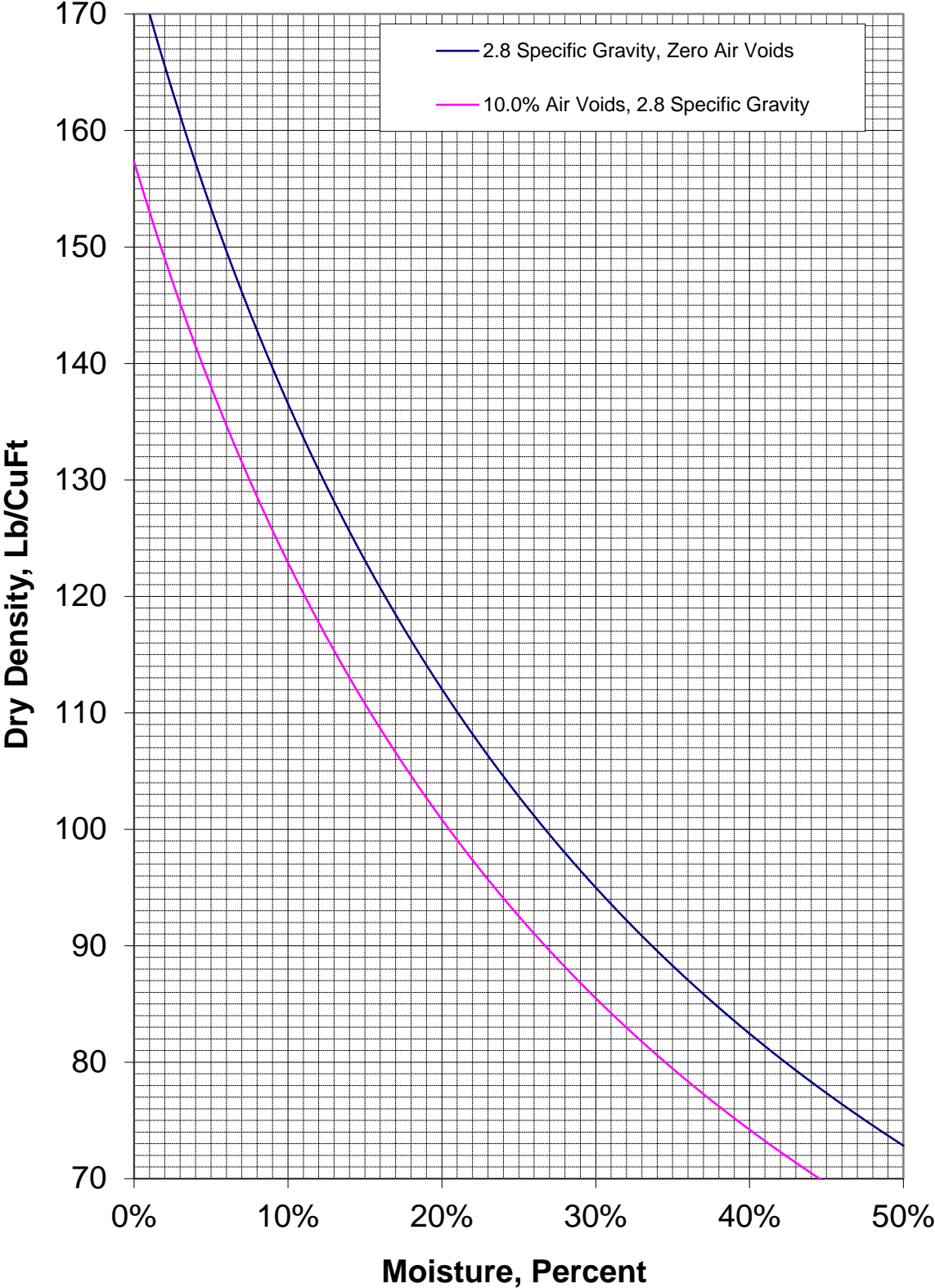

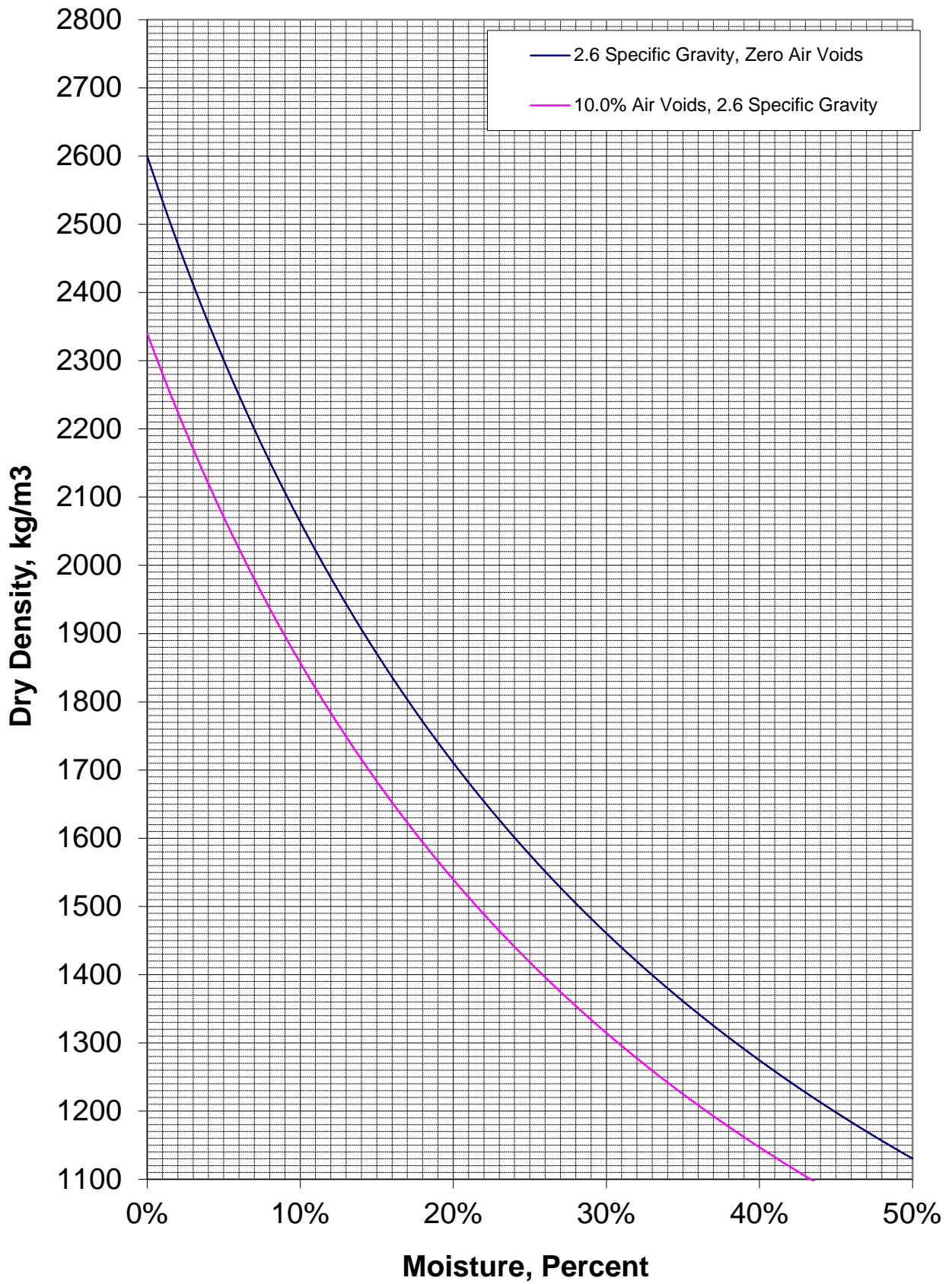

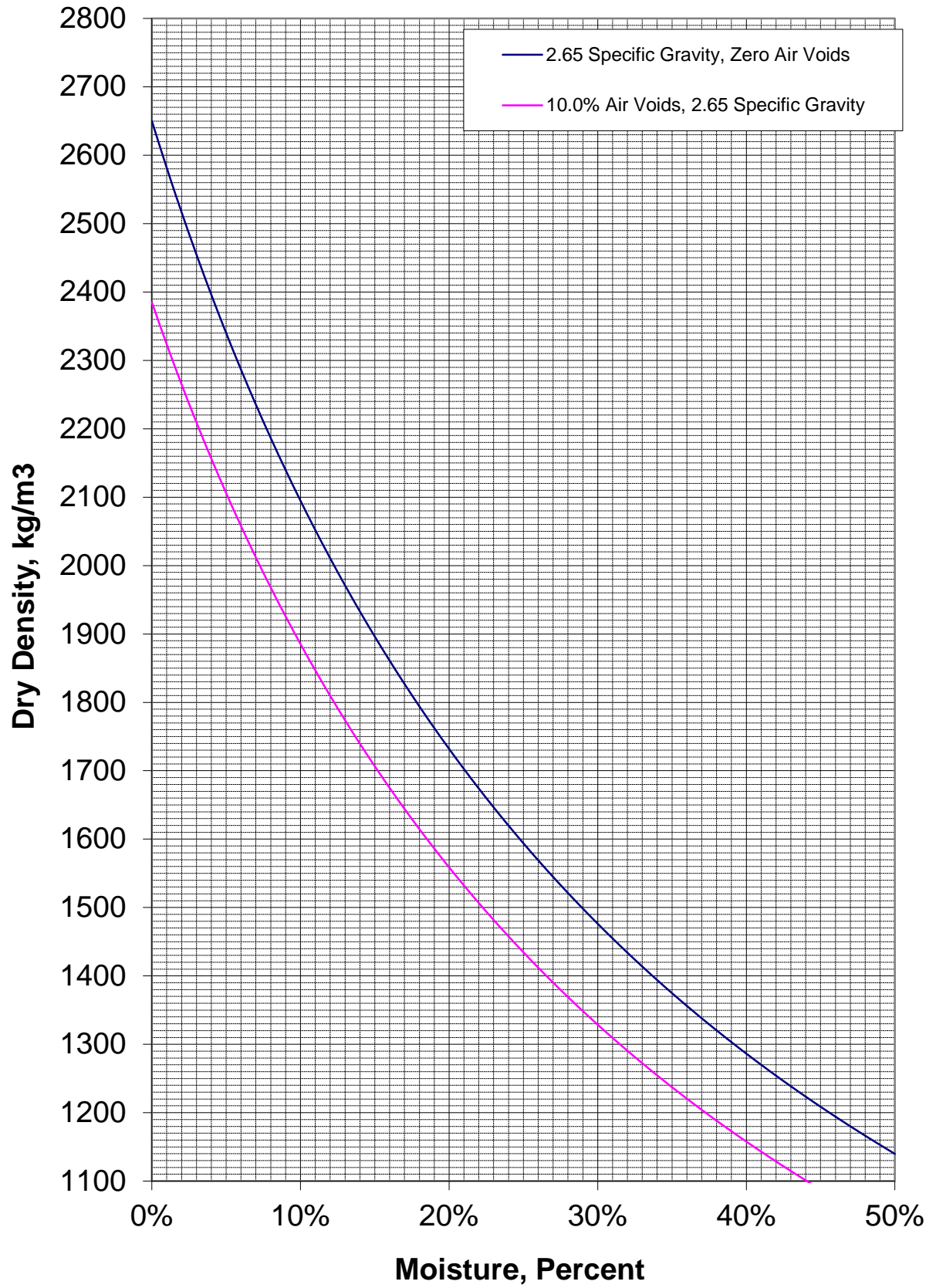

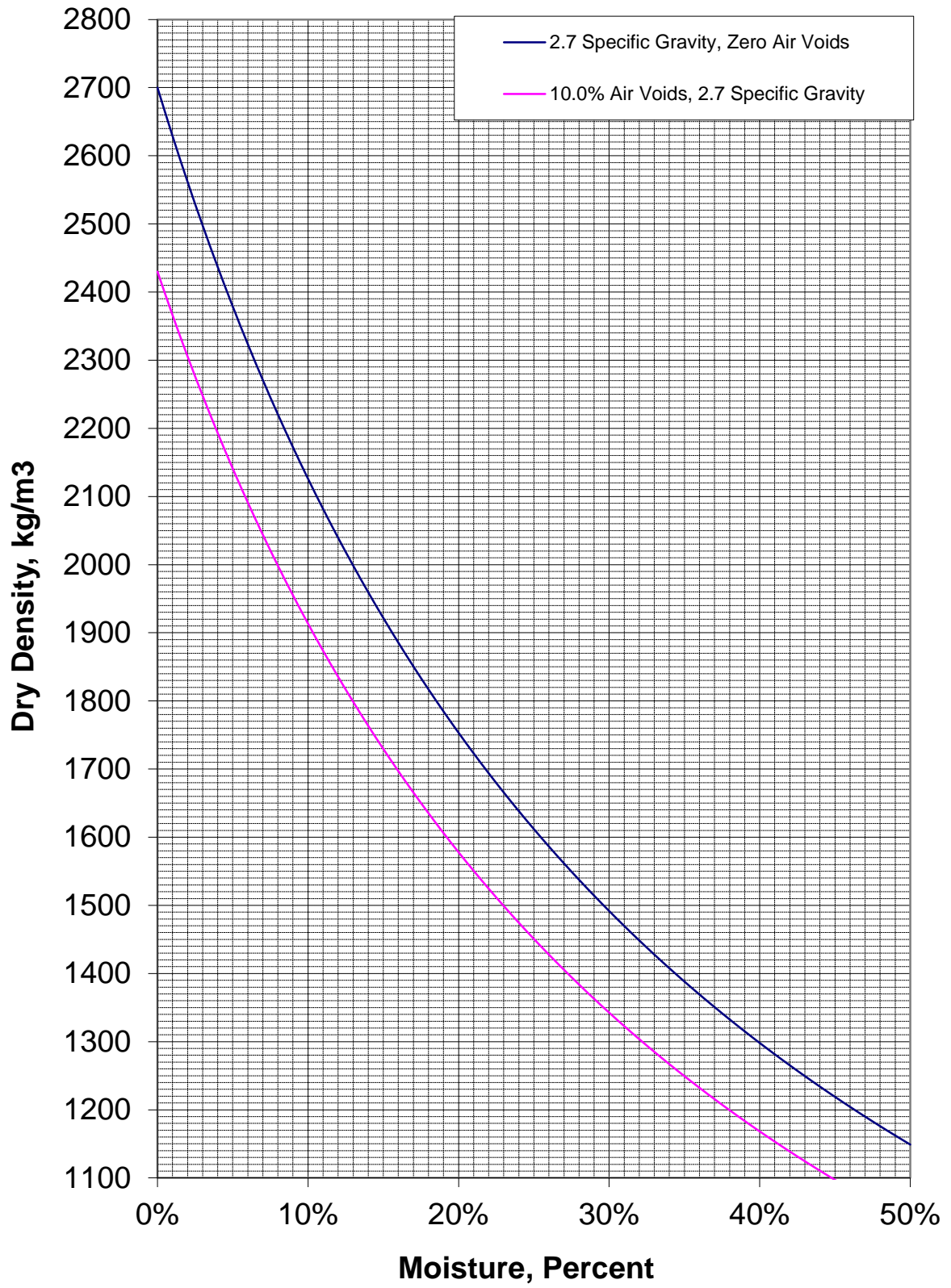

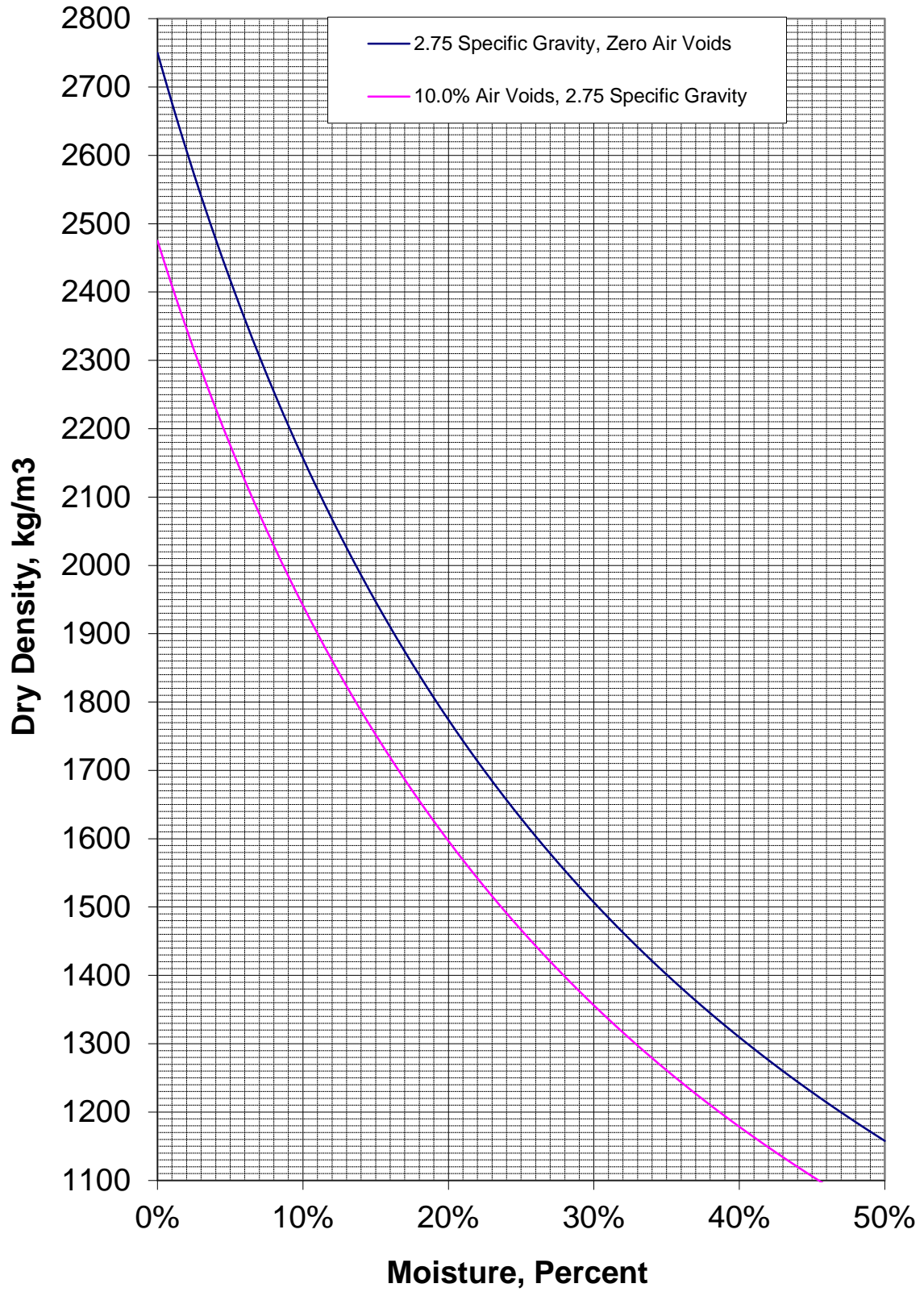

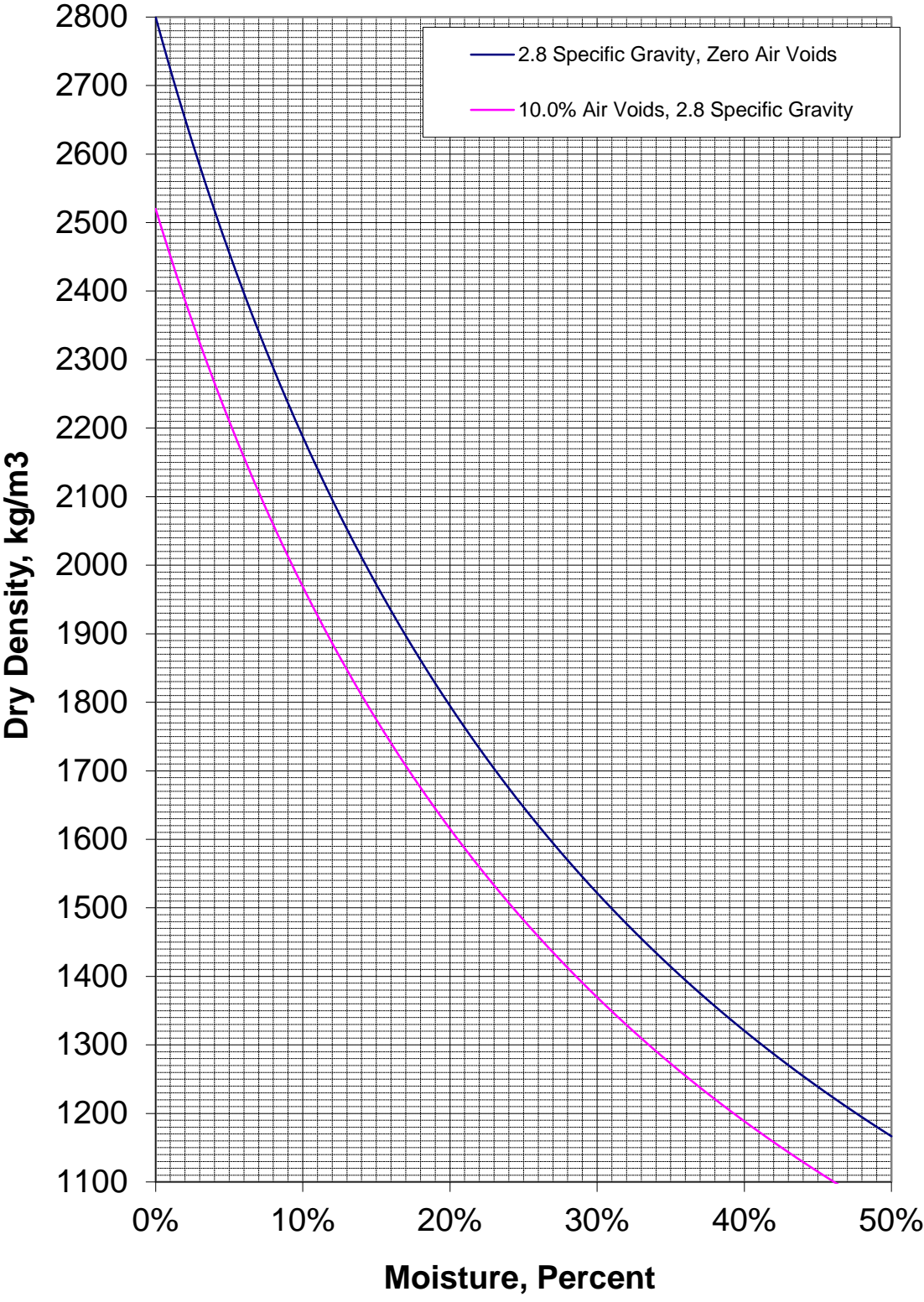

METHODS OF SAMPLING AND TESTING
MT 230-16
METHOD OF TEST FOR THE MOISTURE-DENSITY RELATIONS OF SOILS
USING A 10 LB. (4.54 KG) RAMMER AND A 18 IN. (457 MM) DROP
(Modified AASHTO T 180)

MT 230 is identical to AASHTO T 180 except for the following stipulations:

1. Replace Section 1.5 with the following:

If the specified oversized particle maximum percentage is exceeded (except for material that meets the criteria described in MT 218, Section 4.6.), the replacement method should be used. The replacement method maintains the same percentage of coarse material (passing a 50 mm sieve and retained on a 4.75 mm sieve) in the moisture-density sample as in the original field sample. The material retained on the 19.0 mm sieve shall be replaced as follows: sieve an adequate quantity of the representative soil over the 50 mm and 19.0 mm sieve. Weigh the material retained on the 19.0 mm sieve. Replace this material with an equal mass of material passing the 19.0 mm sieve and retained on the 4.75 mm sieve. Take the material for replacement from the extra portion of the sample.

METHOD OF SAMPLING AND TESTING
MT 232-16
SOIL CORROSION TEST
(Montana Method)

1 Scope

- 1.1 This test method covers procedures and apparatus for determining the pH, conductivity and sulfate content of a soil in corrosion testing.
- 1.2 The intent of these tests is to supplement soil-resistivity measurements and thereby identify conditions under which the corrosion of metals in soil may be accentuated.
- 1.3 At the discretion of the Chief Chemist, MT 532 may be used to determine sulfate content of soils.

2 Referenced Documents**AASHTO**

M 231 Weighing Devices Used in the Testing of Materials

MT Materials Manual

MT 532 Determination of Sulfate Content In Soils by Ion Chromatography

3 Apparatus

- 3.1 *Sieves* – A series of sieves of the following sizes: 1/4 in. (6.3 mm), No. 4 (4.75 mm), No. 10 (2.00 mm) and a pan
- 3.2 *Balance* – A balance with an accuracy of at least 0.1 percent and conforming to the requirements of AASHTO M 231
- 3.3 *Drying Apparatus* – A suitable device capable of drying samples at a temperature of 140°F (60°C)
- 3.4 *Pulverizing Apparatus* – Either a mortar and a rubber-covered pestle or any device suitable for breaking up the aggregations of soil particles without reducing the size of the individual grains.
- 3.5 *Sample Splitter* – A suitable riffle sample splitter or sample splitter for proportional splitting of the sample and capable of obtaining representative portions of the sample without appreciable loss of fines. The width of the container used to feed the riffle splitter should be equal to the total combined width of the riffle chutes. Proportional splitting of the sample on a canvas cloth is also acceptable.
- 3.6 *pH Meter* – With electrodes suitable for laboratory analysis
- 3.7 *Standard Buffer Solutions* – Buffer solutions with known pH values of 4.0, 7.0, 10.0
- 3.8 *Beakers* – 100 ml and 250 ml wide mouth glass beakers with a watch glass for cover
- 3.9 *Glass stirring rods*
- 3.10 *Conductivity Meter* - Suitable for laboratory or field analysis
- 3.11 *Muffle Furnace* – The muffle furnace shall be capable of operation at the temperatures required and shall have an indicating pyrometer accurate within $\pm 25^{\circ}\text{C}$, as corrected, if necessary, by calibration.
- 3.12 *Platinum Crucible* – Platinum crucibles for ordinary chemical analysis should preferably be made of pure unalloyed platinum of 15 to 30-ml capacity. Where alloyed platinum is used for greater stiffness or to avoid sticking of crucible and lid, the alloyed platinum should not decrease in mass by more than 0.2 mg when heated at 1200°C for one hour.

- 3.13 *Filter Paper* – Fast filter paper (Whatman #41) and slow filter paper (Whatman #42)

4 Sample Preparation

- 4.1 The sample as received shall be in a moist condition for pH purposes. If the sample is too wet, it may be dried to a moist condition in air or a drying apparatus not to exceed 140°F (60°C) prior to sample selection (Note 1). A representative test sample to perform the pH test shall then be obtained with a sampler or by splitting or quartering.

Note 1 – Samples dried in an oven or other drying apparatus at a temperature not exceeding 140°F (60°C) are considered to be air dried.

5 Determination of pH

- 5.1 Place a sufficient amount of soil into a 100 ml glass beaker or other suitable container to fill to the 80 ml mark.
- 5.2 Stir enough distilled water into the sample to produce a soil slurry and then cover with a watch glass.
- 5.3 Let the sample stand for a minimum of one hour, stirring every 10 to 15 minutes. This is to allow the pH of the soil slurry to stabilize.
- 5.4 Measure the temperature of the soil and adjust the temperature controller of the pH meter to that of the sample temperature. This adjustment should be done just prior to testing.
- 5.5 Calibrate the pH meter by means of the standard solutions provided.
- 5.6 Stir the sample with a glass rod immediately before immersing the electrode into the soil slurry solution and gently turn the beaker or container to make good contact between the solution and the electrode. **DO NOT** place the electrode into the soil, only into the soil slurry solution.
- 5.7 Immerse the electrode in the solution for at least 30 seconds to allow the meter to stabilize. If the meter has an auto read system, it will automatically signal when stabilized.
- 5.8 Read and record the pH value to the nearest tenth of a whole number.
- 5.9 Rinse the electrode well with distilled water, then dab lightly with tissues to remove any film formed on the electrode. Caution: Do not wipe the electrode as this may result in polarization of the electrode and consequent slow response.
- 5.10 Add approximately 1 gram of calcium carbonate (CaCO₃) to the soil slurry and set aside for approximately 24 hours. Determine the marble pH by following sections 5.4 to 5.9.

6 Determination of Conductivity

- 6.1 Place a sufficient amount of soil on a 100 mm watch glass to completely cover the watch glass. Let stand overnight to allow the sample to dry.
- 6.2 Sieve the dry sample over a No. 10 sieve (2.00 mm) and then pulverize the material remaining on the sieve (+2.00 mm) with a mortar and pestle in such a manner so as to break up the aggregations without fracturing the individual grains. If the sample contains brittle particles, pulverize carefully and with just enough pressure to free the finer material that adheres to the coarser particles.
- 6.3 Place a portion of the pulverized soil in a 100 ml beaker and add distilled water at a ratio of 1 part soil to 2 parts water and let stand for 30 minutes.
- 6.4 After conditioning, pour the water from the beaker into the sample container of the conductivity meter and determine the conductivity to the nearest 0.01 m. mhos.

7 Determination of Sulfate Content

- 7.1 Place 3 grams of the pulverized soil prepared in Section 6 into a 500 ml Erlenmeyer flask.
- 7.2 Add 150 ml of distilled water; stopper the flask and shake to mix.
- 7.3 Centrifuge the sample for 30 minutes.
- 7.4 Decant the liquid into a 250 ml beaker and add 2 ml of dilute Hydrochloric acid (50% strength), to flocculate the suspended particles. Cover with a watch glass and place onto a hot plate until the sample boils.
- 7.5 Remove the beaker from the hot plate and immediately filter through a fast filter paper (Whatman #41).
- 7.6 Add 10 ml of a 10% Barium Chloride ($\text{BaCl}_2 \cdot 2\text{H}_2\text{O}$) solution to the filtered sample to determine the presence of sulfate. (The liquid will become milky in the presence of sulfate).
- 7.7 Cover the beaker with a watch glass and return to the hot plate until the sample boils.
- 7.8 Remove the beaker from the hot plate and immediately filter through a slow filter paper (Whatman #42). Wash the filter with several hot water rinses.
- 7.9 Place the filter paper in a tared 30 ml platinum crucible, place the crucible into a muffle furnace and slowly raise the temperature to 1000°C to burn off filter paper.
- 7.10 Remove the crucible from the muffle furnace and desiccate until cool. Weigh to the nearest 0.0001 grams and record weight as W.
- 7.11 Sulfate Calculation

$$\% \text{ Sulfate (SO}_4) = [(W * 0.4115) / S] * 100$$

Where:

W = Sulfate weight

S = Soil sample weight

8 Report

Include the following parameters in the report:

pH

Marble pH

Sulfate as % SO_4

Conductivity in m. mohs

**CURRENT DATE OF REVISION
MT 300 SECTION
HOT MIX PAVEMENT**

Test Method No.	Title	Pages	Date of Publication or Revision
MT 301	Vacant		
MT 302	Sampling and Testing Bituminous Materials	2 pp	Jul 2014
MT 303	Sampling Bituminous Paving Mixtures	3 pp	Jul 2014
MT 304	Moisture Test on Plant Mix Bituminous Surfacing Aggregates	2 pp	Jul 2014
MT 305	Volume Swell of Bituminous Mixtures	6 pp	May 2009
MT 306	Vacant		
MT 307	Vacant		
MT 308	Vacant		
MT 309	Eliminated (<i>Use AASHTO R 47 Reducing Samples of Hot Mix Asphalt to Testing Size</i>)		
MT 310	Determining the Macro-Texture of a Pavement Surface	6 pp	Dec 2017
MT 311	Vacant		
MT 312	Eliminated (<i>Use AASHTO T 329 Moisture Content of Asphalt Mixtures by Oven Method</i>)		
MT 313	Vacant		
MT 314	Eliminated (<i>Use AASHTO T 166 Bulk Specific Gravity (Gmb) of Compacted Asphalt Mixtures Using Saturated Surface-Dry Specimens</i>)		
MT 315	Vacant		
MT 316	Method of Sampling Recycled Pavement and Field Control of Recycle Paving	5 pp	Jun 2004
MT 317	Vacant		
MT 318	Vacant		
MT 319	Determining the Asphalt Binder Content of Plant Mix Surfacing (PMS) by the Ignition Method	6 pp	Sep 2017
MT 320	Mechanical Analysis of Aggregate Recovered from Ignition Oven Burn.....	1 pp	Jun 2017
MT 321	Determining Theoretical Maximum Specific Gravity of Bituminous Paving Mixtures - "Rice Gravity"	4 pp	Jun 2017
MT 322	Method of Determining the Percent of Adhesion of Bituminous Materials to Aggregate	2 pp	Oct 2004
MT 323	Vacant		
MT 324	Vacant		
MT 325	Vacant (ELIMINATED)		
MT 326	Vacant		
MT 327	Vacant		

**CURRENT DATE OF REVISION
MT 300 SECTION
HOT MIX PAVEMENT**

Test Method No.	Title	Pages	Date of Publication or Revision
MT 328	Establishing Field Target Density for Plant Mix Surfacing Density Control...	1 pp	Jul 2014
MT 329	Procedure for Evaluating Plant Mix Surfacing Failures.....	5 pp	Jun 2004
MT 330	Vacant		
MT 331	Sampling and Evaluating Stripping Pavements	7 pp	Jul 2014
MT 332	Gyratory Compaction of Bituminous Mixtures.	2 pp	Jun 2017
MT 333	Method of Test for the Torsional Recovery of Latex Modified Asphalt Emulsion Residue.....	3 pp	Jun 2004
MT 334	Method of Test for Hamburg Wheel-Track Testing of Compacted Bituminous Mixtures	4 pp	Dec 2017
MT 335	Linear Kneading Compaction of Bituminous Mixtures.....	2 pp	Jul 2014
MT 336	Vacant		
MT 337	Vacant (ELIMINATED)		
MT 338	Eliminated (<i>Use ASTM D6390 Determination of Draindown Characteristics in Uncompacted Asphalt Mixtures</i>)		

METHODS OF SAMPLING AND TESTING
MT 302-14
SAMPLING AND TESTING BITUMINOUS MATERIAL
(Montana Method)

1 Scope

- 1.1 This method covers the procedure for sampling and testing bituminous materials, submitting samples, retaining samples, precautions to be used during sampling, designating who is to take the sample and the recording of information pertinent to the acceptance of bituminous materials.

2 Referenced Documents**AASHTO**

R 66 Sampling Asphalt Materials

ASTM

D140 Standard Practice for Sampling Bituminous Materials

MT Materials Manual

MT 601 Material Sampling, Testing and Acceptance Guide

MT 610 Numbering Subgrade Material, Surfacing Material, Bituminous Treated Material, and Liquid Asphalt

3 Inspection

- 3.1 The Department will witness the taking of any or all acceptance samples by the Contractor or designated personnel.

4 Sampling Procedure

- 4.1 *Importance of proper sampling* - Sampling is equally as important as testing. Take every precaution to obtain samples that show the true nature and condition of the materials they represent. Test results are valuable only when the tests are performed on representative samples. Take samples in accordance with the following procedures, so there will be no question as to validity. This is very important in case of a test failure, which may be the basis for rejection of the material.
- 4.2 Refer to [MT 601](#) for sample size and container type. Use containers furnished by the Department. Do not use second-hand containers, any containers washed or rinsed with solvents, or any containers provided by the contractor. (*Note 1*)

Note 1 – Use metal containers for cut-back asphalt and asphalt cement. Use plastic containers for asphalt emulsions only.

- 4.2.1 Per 402 Specification, all truck tanks, trailer tanks, or other conveyances containing bituminous materials must be equipped with a sampling valve not less than $\frac{3}{8}$ -inch or more than $\frac{3}{4}$ -inch in diameter. These valves may be installed either through the tank's bulkhead at centerline or on the discharge line between the truck unloading pipe and the hose. Sample the contents of railroad tank cars and truck transports, not equipped with a sampling valve, from the pressure side of the unloading pump.
- 4.2.2 Discharge one gallon or sufficient volume of material to clear the sampling device prior to taking the samples. This step is important to ensure a representative and uniform sample is taken.
- 4.2.3 Take the duplicate samples consecutively with a minimum lapse of time from the same tank or trailer.

Note 2 – Sample all emulsion shipments, regardless of the size of the shipment, within a reasonable time as to not compromise the sample. If emulsion sample has been diluted, note this on the sample record. Protect the emulsions samples from freezing. Re-sample when the material is stored without agitation for three or more days before use.

- 4.2.4 Leave the screw caps loose until the contents cool so the contraction of the asphalt will not collapse the containers. Remove any spillage on the outside of the container with a clean, dry cloth, cotton waste or paper towels. Do not use solvents (diesel fuel, gasoline, etc.) for this purpose.

Note 3 – For other sampling methods, refer to AASHTO R 66 and ASTM D140.

5 Submitting, Reporting and Testing of Samples

5.1 Submitting

- 5.1.1 After samples are taken, immediately forward to the Materials Bureau for testing.

5.2 Reporting

- 5.2.1 Create a SiteManager Sample Record to submit samples.
- 5.2.2 Refer to [MT 610](#) for numbering the bituminous material samples.

5.3 Testing

- 5.3.1 The Materials Bureau will perform tests for all specification requirements on samples selected at random for each project.
- 5.3.2 The Materials Bureau will immediately notify the Project Manager, who in turn will notify the Prime Contractor, when the result of a series of tests is not within the specification limits.
- 5.3.3 In the event of a failure, refer to applicable Specification.

6 Certification of Shipments

- 6.1 Ensure suppliers of bituminous materials furnish the Project Manager or their representative, one copy of the original bill of lading or invoice and a Certificate of Compliance. Ensure this documentation accompanies each tank car, truck-trailer tank, or other individual conveyance of bituminous materials shipped, or hauled to the project. This certificate, signed by a supplier's responsible representative, attests to the fact that the bituminous material complies with Department specifications for the type and grade of material represented and the conveyance was inspected and found to be free of contaminating material.
- 6.2 The Certificate of Compliance is the basis for tentative acceptance and use of the material. Do not allow the shipment to be tentatively accepted or incorporated in the work without the receipt of the certification. It may be included on the bill of lading or invoice or it may be a separate document attached to the bill of lading. The Project Manager will retain the certificate and bill of lading in the project files and digital files for record purposes.

METHODS OF SAMPLING AND TESTING
MT 303-14
SAMPLING BITUMINOUS PAVING MIXTURES
(Modified AASHTO T 168)

1 Scope

- 1.1 These methods cover sampling of bituminous paving mixtures at points of manufacturer, storage, delivery, or in place.

2 Referenced Documents

AASHTO

- R 47 Reducing Samples of Hot Mix Asphalt (HMA) to Testing Size
 R 97 Sampling Asphalt Mixtures

ASTM

- D979 Sampling Bituminous Paving Mixtures

MT Materials Manual

- MT 601 Materials Sampling, Testing and Acceptance Guide

Alberta Transportation ATT Test Procedures

- ATT 37 Sampling, Mixes

3 Inspection

- 3.1 Inspect the material to determine discernible variations. Ensure the contractor provides equipment needed for safe and appropriate inspection and sampling.

4 Sampling Procedure

- 4.1 *Importance of proper sampling* – Sampling is equally as important as testing. Take every precaution to obtain samples that show the true nature and condition of the materials they represent. Test results are valuable only when the tests are performed on representative samples. Take samples in accordance with the following procedures, so there will be no question as to validity. This is very important in case of a test failure, which may be the basis for rejection of the material.
- 4.2 *Sampling from Truck Transports* – Select the units to be sampled from the production of materials delivered. Obtain a minimum of three approximately equal increments as shown in Figure 1 and combine to form a field sample. Obtain the sample by collecting the increments with a scoop or shovel. Avoid sampling the extreme top surface.

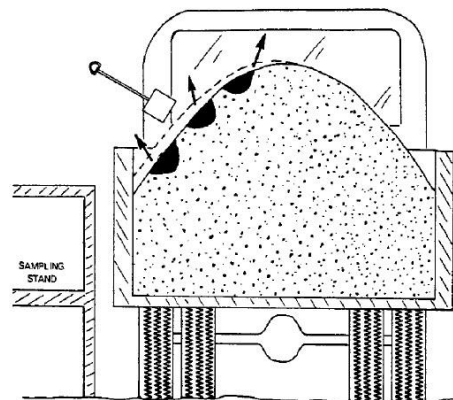

Figure 1. Sampling from Truck Transports

- 4.3 *Sampling from a Paver Auger* – Obtain samples from the end of the auger using a square head shovel. Place the shovel in front of the auger extension, with the blade flat upon the surface to be paved over. Allow the front face of the auger stream to cover the shovel, and remove the shovel before the auger reaches the shovel by lifting it upward as vertically as possible. Obtain sample from a minimum of three equal increments of material.
- 4.4 *Sampling from a Windrow* – Obtain a representative sample from the windrow of one transport unit. Combine a minimum of three approximately equal increments as shown in Figure 2.
1. Use the shovel to flatten a sufficient length of the windrow, discarding the material to either side.
 2. Dig into the windrow's top at three or more equally distributed points along its flattened portion. Do not include material from the subgrade or base. The sample is the total mix from three or more holes.

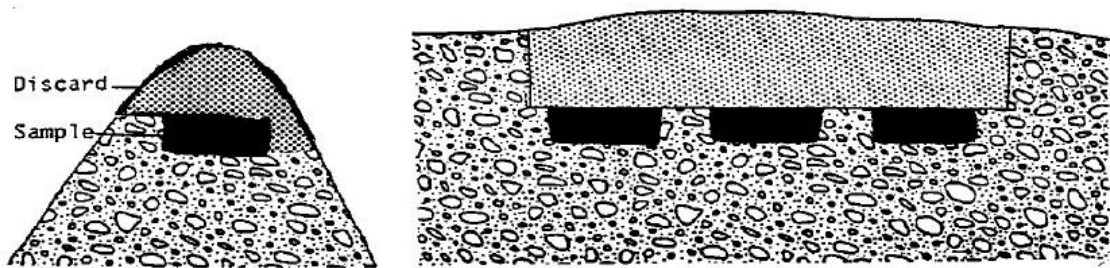

Figure 2. Sampling from a Windrow

- 4.5 *Sampling from Bituminous Cold Mix or Recycled Asphalt Pavement (RAP) Stockpiles* – Cold mixes that are in a stockpile for some time may develop a crust on the surface of the pile. Remove this crust to a depth of 4 inches, over an area of one square yard, to expose the unweathered mix as shown in Figure 3. Stir the exposed stockpile and obtain three approximately equal samples selected at random, and combine to form a field sample.

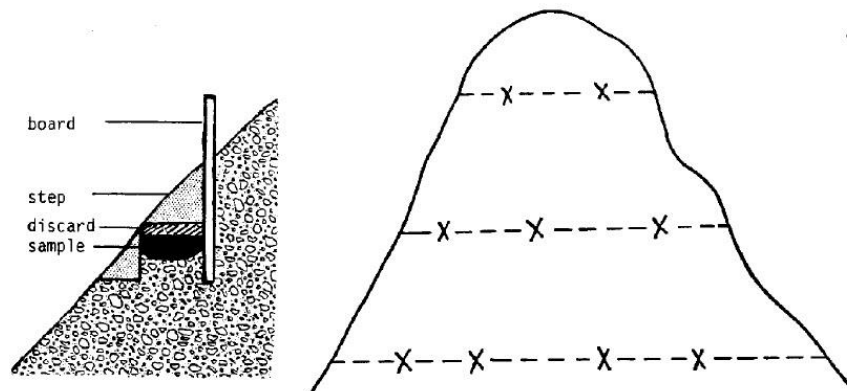

Figure 3. Sampling from a Stockpile

5 Number and Quantities of Field Samples

- 5.1 Designate each unit from which a field sample is to be obtained prior to sampling.
- 5.2 Refer to [MT 601](#) for sample size. The quantities depend on the type and number of tests to which the material is to be subjected. Obtain sufficient material to provide for the proper execution of standard control and acceptance tests.

6 Securing or Submitting Samples

- 6.1 Transport samples in containers constructed to minimize heat loss, contamination, or damage to the sample from mishandling during shipment.
- 6.2 Record pertinent information in the Quality Assurance Suite (QA Suite) Plant Mix section.
- 6.3 Using the [Hamburg Sampling Guideline](#), attach identification to each Hamburg sample sent to a district or headquarter lab.
- 6.4 Create a SiteManager Sample Record and attach to any plant mix sample sent to a district or headquarter lab.
- 6.5 Use tamper resistant container(s) when sample(s) leave Department custody.

METHODS OF SAMPLING AND TESTING
MT 304-14
MOISTURE TEST ON PLANT MIX
BITUMINOUS SURFACING AGGREGATES
(Montana Method)

1 Scope

This test method covers the determination of the moisture content of bituminous surfacing aggregates by various drying methods.

2 Referenced Documents***AASHTO Standards***

M 231 Weighing Devices Used in the Testing of Materials

MT Materials Manual

MT 201 Sampling Roadway Materials

3 Terminology

- 3.1 Constant mass – the state at which a mass does not change more than 0.10 percent, after additional drying for the defined time interval in Table 3.1.

Table 3.1
Methods of Drying

Heat Source	Specific Instructions	Drying increments (minutes)
Controlled: Forced draft (preferred), ventilated, or convection oven	110 ±5°C (230 ±9°F)	30
Uncontrolled: Hot plate, Heat Lamp, etc.	Stir frequently	20
Microwave	Heap sample and cover with ventilated lid	10

4 Apparatus

Ensure equipment used meets the following requirements

- 4.1 *Drying Apparatus* - any suitable device capable of drying samples.
- 4.2 *Balance* – balance or scale with a capacity larger than the size of the sample being tested. The balance or scale must have a sensitivity of 0.1 gram and conform to the requirements of AASHTO M 231.
- 4.3 *Sample container* – not affected by heat and of sufficient size to contain a test sample of at least 4,000 g without danger of spilling.

5 Sampling

- 5.1 Obtain a representative sample of at least 3 pounds from each bin, stockpile, or cold feed belt per [MT 201](#). Immediately place the material, from each separate bin, stockpile, or cold feed belt, into a weighed container and seal.

6 Procedure

- 6.1 After weighing the container with aggregate, transfer the material to drying pans and dry to constant mass in an approved manner. Stir the sample occasionally to facilitate drying.
- 6.2 Reweigh sample and container when the sample has been dried to constant mass.

Note 1 – Perform moisture testing on mixes showing the following properties:

- *Foaming on the surface of the coarse aggregate particles*
- *Excessive slumping of the mix in the truck*
- *Condensed water dripping from the truck box*
- *Bubbles or blisters forming on the surface immediately behind the paver*

Ordinarily these conditions will not develop if the moisture content is below approximately 2 percent.

7 Calculations

- 7.1 Compute the moisture content of each sample of the aggregate using the following formula:

$$M = \left(\frac{W-D}{D-C} \right) \times 100$$

where:

M = percent of moisture

W = wt. of wet sample and container

D = wt. of dry sample and container

C = wt. of container

- 7.2 Compute the composite moisture content of the total aggregate according to the following example:

Aggregate Size	Fraction of Job Mix	x	Moisture Content, Percent
3/4" to 3/8"	0.20	x	2.00 = 0.40
3/8" to No. 10	0.40	x	1.00 = 0.40
Passing No. 10	0.40	x	0.50 = 0.20
Composite Moisture Content			= 1.00

8 Reporting

- 8.1 Report the moisture content to the nearest 0.10 percent.

METHODS OF SAMPLING AND TESTING
MT 305-09
METHOD OF TEST FOR VOLUME SWELL OF BITUMINOUS MIXTURES
(MONTANA TEST METHOD)

1 Scope

- 1.1 This test method provides for the determination of the maximum volume swell of compacted aggregates, soil, sand, or combination of mixtures passing the 10 Mesh (2.0 mm) sieve and stabilized with bituminous material.

2 Apparatus**2.1 Compaction Apparatus:**

- 2.1.1 *Forming mold* – This forming mold shall be a steel cylinder 2.50 inches (63.5 mm) or greater in outside diameter, 2.000 - 2.001 inches (50.80 - 50.8254 mm) inside diameter, and approximately 2.75 inches (69.85 mm) high. One end shall be recessed 0.245 - 0.250 inches (6.223 - 6.350 mm) with an inside diameter of 2.250 - 2.252 inches (57.1500 - 57.2008 mm) to fit the 2.247 - 2.249 inch (57.0738 - 57.1246 mm) base if the base plate method is used.

- 2.1.2 *Plungers* – Cylindrical steel plungers, fitted to the molding cylinders, 1.997 ± 0.001 inch (50.7238 ± 0.0254 mm) in diameter and 3 inches (76.2 mm) high.

- 2.1.3 *Base* – Solid steel, circular plate 1 inch (25.4 mm) thick and 3 inches (76.2 mm) in diameter, beveled and machined to a 2.247 - 2.249 inch (57.0738 - 57.1246 mm) top diameter above the mold seat.

- 2.2 *Compression Testing Machine or Press* – A compression machine or press capable of applying loads of 10,000 pounds (4535.9 kg.) or greater and indicating the applied load with a sensitivity of 50 pounds (22.7 kg.) or less.

2.3 Mixing Apparatus:

- 2.3.1 *Mixing pans* – shall be smooth and conform to the following dimensions:

Bottom inside diameter = approximately 4-3/4" (120.65 mm)

Top inside diameter = approximately 6-1/4 in. (158.75 mm)

Height = approximately 3 in. (76.2 mm)

- 2.3.2 *Spatula* – approximately 7 in. (177.8 mm) long and 1/2 in. (12.7 mm) wide.

- 2.3.3 *Putty knife* – approximately 1-1/2 in. (38.1 mm) wide with a rounded tip.

- 2.3.4 *Large metal scoop* with handle (24 to 48 oz.).

- 2.3.5 *Anti-slip, flexible rubber gloves (nitrile or vinyl).*

- 2.4 *Heater* – An electric thermostatically controlled hot plate for warming pans of bituminous mix.

- 2.5 *Vacuum Desiccator* – of convenient size with a vacuum gauge incorporated on the lid. The gauge shall be calibrated in inches or centimeters of Hg (mercury) vacuum.

- 2.6 *Hand or motor driven vacuum pump* with approximately two feet of plastic vacuum hose.

- 2.7 *Stop-cock grease for desiccator seal.*

- 2.8 *Screw clamp.*

- 2.9 *Measuring and weighing apparatus.*

- 2.9.1 *A balance* with a capacity of 500 grams and sensitive to 0.1g.

- 2.9.2 *A measuring device* that is accurately calibrated and equipped to determine heights and diameters of test specimens to the nearest 0.01 cm.
- 2.9.3 *Mercury Displacement Cup* – A glass or plastic cup with flat ground edge of convenient size to contain test specimens for mercury displacement measurement.
- 2.9.4 *Glass dish* approximately 10 x 6 x 2 in. (254 x 152.4 x 50.8 mm)
- 2.9.5 *Porcelain pan* approximately 15 x 10 x 2-1/2 in. (381 x 254 x 63.5 mm)
- 2.10 *Drying Oven* – A thermostatically controlled drying oven capable of maintaining a temperature of $140 \pm 5^{\circ}\text{F}$ ($60 \pm 3^{\circ}\text{C}$)
- 2.11 *A 4 mesh (4.75 mm) and a 10 mesh (2.0 mm) sieve.*
- 2.12 Thermometers, beakers, and a 100 ml, glass, graduated cylinder with intervals of 1.0 mm.
- 2.13 *Pulverizing Apparatus* – Either a mortar and rubber covered pestle or a mechanical device consisting of a power-driven rubber covered mallet suitable for breaking up the aggregations of soil particles without reducing the size of the individual grains.

3 Materials

- 3.1 *Distilled water* with a pH of approximately 7. (Tap water is satisfactory if it does not interfere chemically with the test.)
- 3.2 *Bituminous material* - 200/300 Pen A.C.
 - 3.2.1 200/300 Pen A.C. should be replaced with new asphalt at the beginning of each construction season.
- 3.3 *Mercury*
 - 3.3.1 Mercury (Hg) is a poison and can be absorbed through the respiratory tract, the intestinal tract or through unbroken skin. Mercury is a cumulative poison and is a very volatile element. Dangerous levels are readily attained in the air at 77°F (25°C). Tests involving the use of Mercury should be performed under conditions of adequate ventilation. A fume hood is recommended for large numbers of samples or where the test is to be carried out frequently over extended periods of time. Protective gloves should be worn under conditions here skin contact with mercury may occur.
 - 3.3.2 This test procedure does not purport to address all of the safety concerns, if any, associated with its use. It is the responsibility of the user of this test procedure to establish appropriate safety and health practices and determine the applicability of regulatory limitation prior to use.

4 Preparation of Aggregate

- 4.1 A representative sample of the 10 mesh (2.00 mm) material as described in AASHTO R 58 shall be prepared. The sample shall be large enough to produce approximately 400 grams of minus 10 mesh (2.00 mm) material at the conclusion of the pulverizing procedure.

5 Volume Swell Procedure

The caliper method will be used to test all volume swell samples. If the caliper method yields a volume swell of 8.0 or greater than a sample will be submitted to either the Helena Materials Lab or the Billings District Lab for testing using the mercury method. The mercury method will only be performed in the Helena Materials Lab or the Billings District Lab. Porous briquettes that may entrap mercury shall be measured with calipers only.

5.1 Volume Swell Procedure – Caliper Method

- 5.1.1 Warm the 200/300 pen asphalt cement for mixing to approximately $250 \pm 15^{\circ}\text{F}$ ($121 \pm 8^{\circ}\text{C}$).
- 5.1.2 Stabilize the hot plate at 425°F to 475°F (218°C to 246°C).
- 5.1.3 Stir the sample prepared in paragraph 4 with a spatula and transfer a 100 gram sample to the weighing scoop. Use the spatula to obtain a uniform discharge and to pull material from the bottom of the sample container when transferring the material. If desired, the material may be preheated in an oven $230 \pm 9^{\circ}\text{F}$ ($110 \pm 5^{\circ}\text{C}$).
- 5.1.4 Transfer the 100 gram sample from the weighing scoop to the mixing pan, stir with a putty knife and shake the material to one side of the mixing pan.
- 5.1.5 Place the mixing pan and sample on the balance and add 6.5 grams of 200/300 Pen A.C., do not pour asphalt on material; place the pan back on the hot plate.
- 5.1.6 When asphalt starts to flow into the sample, start mixing rapidly with a putty knife while shaking the mixing pan close to the hot plate. Avoid overheating the mix, as evidenced by smoking asphalt. Mix and shake until a thorough mixture is obtained. See Note 1.

Note 1 – In the case of material having poor adhesion, the larger particles will only be slightly coated. Do not add more asphalt. Mix and shake until maximum coverage is obtained.

- 5.1.7 Pour the mixture from the mixing pan into a small scoop. Pour the mixture from the scoop into the assembled mold using the spatula to assist in obtaining a uniform discharge from the scoop. Insert the top plunger with a twist and a light tamp to seat firmly. Place the mold in the compression machine and at a uniform rate increase the load to a total of 6280 pounds in no less than 15 seconds. Maintain the maximum load for one minute and release. Remove the base plate with a twisting motion and mark the briquette in the mold with a wax crayon, applying light pressure.
- 5.1.8 After removing the base plate with a twisting motion and marking the briquette, turn the assembly upside down. Place the sleeve on top of the forming mold and using the jack apply pressure to the sleeve and top plunger. This will push the briquette and top plunger up into the sleeve. See Note 2. Cool and cure the briquette for three hours at room temperature.

Note 2 – If the briquettes tend to stick to the mold or plungers, preheat mold to 140°F (60°C).

- 5.1.9 Wipe the forming mold, base plate and plungers clean with a suitable solvent and dry with a cloth before forming each briquette.
- 5.1.10 Measure and record the height and radius of the cured briquette. To obtain the height of the specimen, measure and record the height (flats of the specimen) in four locations. Measurements should be taken at 90 degree intervals. Average the four measurements and use the average height for the calculations. To obtain the radius of the specimen, measure and record the diameter of the specimen (sides) in four locations. Measurements should be taken at 45 degree intervals. Average the four measurements and divide by 2 to obtain the average radius. Use the average radius for the calculations. Refer to Paragraph 6.1.2 (calculations) to determine the volume of the cured briquette.
- 5.1.11 Check the vacuum equipment for leaks before any briquettes are put into the desiccator.

- 5.1.12 Fill the vacuum desiccator with distilled water and allow to stabilize at room temperature. Completely submerge the briquette in the distilled water and seal the top. See Note 3.

Note 3 – A perforated tray is supplied for a second layer of briquettes.

- 5.1.13 Subject the briquette to 8 inches (20.3 cm) of mercury vacuum for one hour. The 8 inches of vacuum will be applied within the desiccator in not less than one minute. The vacuum is maintained for one hour and released gradually to avoid pressure shock to the briquettes.
- 5.1.14 Keep the briquette completely submerged in the distilled water at room temperature for an additional 23 hours. If necessary to transfer to another container of distilled water, wait 15 minutes after releasing pressure before effecting transfer.
- 5.1.15 Remove the briquette, blot the excess water and weigh. Measure and record the height and radius of the swollen briquette. To obtain the height of the specimen, measure and record the height (flats of the specimen) in four locations. Measurements should be taken at 90 degree intervals. Average the four measurements and use the average height for the calculations. To obtain the radius of the specimen, measure and record the diameter of the specimen (sides) in four locations. Measurements should be taken at 45 degree intervals. Average the four measurements and divide by 2 to obtain the average radius. Use the average radius for the calculations. Refer to Paragraph 6.1.2 (calculations) to determine the volume of the cured briquette and the percent of volume swell. In no event will the briquette be allowed to set for more than ten minutes before measuring is completed. The sides of the briquette will be squeezed for recording condition of the briquette such as hard, firm, soft, soft and cracked, or disintegrated. Refer to paragraph 6.1.1 (calculations) to determine the percent of volume swell. (See Note 4)

Note 4 – The test specimen shall be measured immediately after excess water is blotted off the specimen. When measuring with calipers, take four measurements on the sides of the specimen and four measurements on the flats of the specimen at 90 degree intervals and record. The average of the recordings will be used for the calculation.

5.2 Volume Swell Procedure – Mercury Method

The Helena Materials Lab and the Billings District Lab are the only labs that will be performing volume swell testing using Mercury. A designated set of testing apparatus will be used to test using mercury (such as a Vacuum Desiccator designated for mercury method samples). The mercury method briquettes will be stored in a labeled container with a lid. The desiccator disposal water will also be stored in a labeled container with a lid. The waste products will be stored near the mercury method equipment and when a container of approximately five gallons is collected, Environmental Services will be contacted for disposal.

- 5.2.1 Warm the 200/300 Pen Asphalt Cement for mixing to approximately $250 \pm 15^{\circ}\text{F}$ ($121 \pm 8^{\circ}\text{C}$).
- 5.2.2 Stabilize the hot plate at 425 to 475°F (218 to 246°C).
- 5.2.3 Stir the sample prepared in paragraph 4 with a spatula and transfer a 100 gram sample to the weighing scoop. Use the spatula to obtain a uniform discharge and to pull material from the bottom of the sample container when transferring the material. If desired, the material may be preheated in an oven $230 \pm 9^{\circ}\text{F}$ ($110 \pm 5^{\circ}\text{C}$).
- 5.2.4 Transfer the 100 gram sample from the weighing scoop to the mixing pan, stir with a putty knife and shake the material to one side of the mixing pan.
- 5.2.5 Place the mixing pan and sample on the balance and add 6.5 grams of 200/300 Pen A.C., do not pour asphalt on material; place the pan back on the hot plate.

- 5.2.6 When asphalt starts to flow into the sample, start mixing rapidly with a putty knife while shaking the mixing pan close to the hot plate. Avoid overheating the mix, as evidenced by smoking asphalt. Mix and shake until a thorough mixture is obtained. See Note 1.
- 5.2.7 Pour the mixture from the mixing pan into a small scoop. Pour the mixture from the scoop into the assembled mold using the spatula to assist in obtaining a uniform discharge from the scoop. Insert the top plunger with a twist and a light tamp to seat firmly. Place the mold in the compression machine and at a uniform rate increase the load to a total of 6280 pounds in no less than 15 seconds. Maintain the maximum load for one minute and release. Remove the base plate with a twisting motion and mark the briquette in the mold with a wax crayon, applying light pressure.
- 5.2.8 After removing the base plate with a twisting motion and marking the briquette, turn the assembly upside down. Place the sleeve on top of the forming mold and using the jack apply, pressure to the sleeve and top plunger. This will push the briquette and top plunger up into the sleeve. See Note 2. Cool and cure the briquette for three hours at room temperature.
- 5.2.9 Wipe the forming mold, base plate and plungers clean with a suitable solvent and dry with a cloth before forming each briquette.
- 5.2.10 Weigh the cup filled with mercury and record the weight (W1). Place the cured briquette in the cup and allow the mercury to displace by pressing the plastic plate flatly, squarely and firmly down on the specimens top surface until the plate is seated on the top rim on the cup and the excess mercury is fully displaced. Remove the cured briquette. Weigh and record the weight of the mercury and the cup minus the weight of the mercury lost due to immersion of the cured briquette (W2). Wear Rubber exam gloves at all times when while testing with mercury.
- 5.2.11 Check the vacuum equipment for leaks before any briquettes are put into the desiccator.
- 5.2.12 Fill the vacuum desiccator with distilled water and allow to stabilize at room temperature. Completely submerge the briquette in the distilled water and seal the top. See Note 3.
- 5.2.13 Subject the briquette to 8 inches (20.3 cm) of mercury vacuum for one hour. The 8 inches of vacuum will be applied within the desiccator in not less than 1 minute. The vacuum is maintained for one hour and released gradually to avoid pressure shock to the briquettes.
- 5.2.14 Keep the briquette completely submerged in the distilled water at room temperature for an additional 23 hours. If necessary to transfer to another container of distilled water, wait 15 minutes after releasing pressure before transfer.
- 5.2.15 Remove the briquette and blot the excess water. Place the swollen briquette in the mercury cup and allow the briquette to displace the mercury by pressing the plastic plate flatly, squarely and firmly down on the specimen's top surface until the plate is seated on the top rim on the cup and the excess mercury is fully displaced. Weigh and record the weight of the mercury and the cup minus the weight of the mercury lost due to immersion of the swollen briquette (W3). In no event will the briquette be allowed to set for more than ten minutes before weighing is completed. The sides of the briquette will be squeezed for recording condition of the briquette such as hard, firm, soft, soft and cracked, or disintegrated. Refer to paragraph 6.1.2 (calculations) to determine the percent of volume swell. See Note 5.

Note 5 – The test specimen shall be weighed immediately after excess water is blotted off the specimen. If the specimen is allowed to set for any amount of time, the specimen will dry out and shrink giving erroneous swell results.

6 Calculation

6.1 The volume swell, expressed as a percentage can be calculated by either of the two following methods.

6.1.1 Percent Volume Swell by Caliper Method

$$V = \pi r^2 h$$

where:

V = volume of specimen

π = 3.1416

r = radius of specimen

h = height of specimen

and

$$S = \frac{V_2 - V_1}{V_1} \times 100$$

where:

S = volume swell, percent

V1 = volume of specimen before immersion, by caliper

V2 = volume of specimen after immersion

6.1.2 Percent Volume Swell by Mercury Method

$$S = \frac{W_2 - W_3}{W_1 - W_2} \times 100$$

where:

S = volume swell, percent

W1 = weight of cup filled with mercury

W2 = weight of mercury and cup minus mercury lost because of immersion of cured briquette

W3 = weight of mercury and cup minus mercury lost because of immersion of swollen briquette

7 Report

7.1 The report shall consist of the following:

7.1.1 Percent of Volume Swell,

7.1.2 Condition of specimen.

METHODS OF SAMPLING AND TESTING
MT 310-17
METHOD OF DETERMINING THE MACRO-TEXTURE OF A PAVEMENT SURFACE
(Modified ASTM E965)

1 Scope

- 1.1 This method describes the procedures for determining the average macro-texture depth of micro-milled concrete surfaces and micro-milled and cold-milled plant mix surfaces.
- 1.2 This standard does not purport to address all the safety concerns associated with its use. It is the responsibility of the user of this procedure to establish appropriate safety and health practices and to determine the applicability of regulatory limitations prior to use.

2 Reference Documents

AASHTO

M 247 Glass Beads Used in Traffic Paints

ASTM

E965 Measuring Pavement Macrottexture Depth Using a Volumetric Technique

MT Materials Manual

MT 606 Procedure for Selecting Sampling locations by random sampling technique

METHOD A – COLD-MILLED PLANT MIX SURFACES

3 Apparatus

- 3.1 *Filler* – Type 1 glass beads in accordance with AASHTO M 247.
- 3.2 *Spreader* – A flat, stiff, hard disk made from methyl methacrylate (Plexiglas) with a thickness of 0.5 ± 0.1 inch, diameter of 8 ± 2 inch and a round handle affixed in the center
- 3.3 *Graduate* – A conical or cylindrical shape graduate, 250 ml capacity
- 3.4 *Brushes* – A stiff wire brush and a soft bristle brush
- 3.5 *Container* – A small sample container with a secure and easily removable cover, at least 200 ml capacity
- 3.6 *Screen* – A shield to protect the test area location from air turbulence created from wind or traffic.

4 Test Material Preparation

- 4.1 Prepare one sample container for each test area location.
- 4.1.1 Fill the graduate with 200 ± 2 ml of filler.
- 4.1.2 Gently tap the side of the graduate to level the surface of the filler.
- 4.1.3 Place the measured volume of filler in the container.
- 4.1.4 Label the container with type and quantity of filler.

5 Procedure

5.1 Test Area

- 5.1.1 Randomly select a test area location(s) on the milled pavement surface in accordance with MT 606.
- 5.1.2 Inspect the test area location and ensure it is a dry, homogeneous site, free of unique or localized features such as cracks, joints, stripping and patching.
- 5.1.3 If localized features are present, move up-station at the same transverse offset until a suitable site is found.
- 5.1.4 Gently clean an area of about 1 foot by 1 foot for the test area location using the stiff wire brush to remove any residue, debris or loosely bonded material. Be careful not to dislodge bonded material. After using the stiff wire brush, gently brush the test area location with the soft bristle brush to remove any remaining debris.
- 5.1.5 Place the screen on the milled pavement surface to protect the test area location from air turbulence.

5.2 Test Measurement

- 5.2.1 Hold the container with filler no more than 4 inches above the pavement at the test area location.
- 5.2.2 Pour the measured volume of filler from the container onto the milled pavement surface in a conical pile.
- 5.2.3 Place the spreader lightly on top of the conical pile of filler being careful not to compact the filler.
- 5.2.4 Move the spreader in a slow, circular motion to disperse the filler in a circular area and to create a defined crest around the perimeter.
- 5.2.5 Continue spreading the filler until it is well dispersed and the spreader rides on top of the high points of the milled pavement surface.
- 5.2.6 Measure and record the diameter of the circular area four times, at intervals of 45° and to the nearest 0.1 inch, as shown in Figure 1.
- 5.2.7 Measure the diameter of the circular area from the top (crest) of the slope on one side, through the center, and to the top (crest) of the slope on the other side of the circular area.

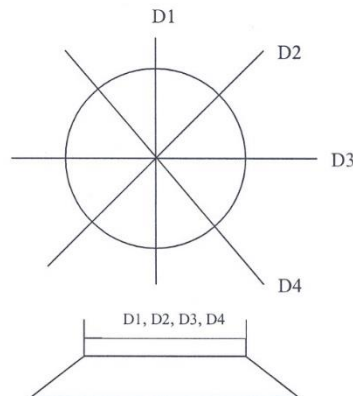

Figure 1: Typical Measuring Pattern

- 5.2.8 Calculate the average diameter of the circular area covered by the filler (Equation 9.1).
- 5.2.9 Determine the macro-texture thickness of the milled pavement surface by using the cross reference table in Section 9.3 below.
- 5.3 Remove the filler material from the location using the soft bristle brush and repeat Subsection 5.2 two more times.

METHOD B – MICRO-MILLED CONCRETE AND PLANT MIX SURFACES

6 Apparatus

- 6.1 *Filler* – Type 1 glass beads in accordance with AASHTO M 247
- 6.2 *Spreader* – A flat, stiff hard disk with a thickness of 1.0 ± 0.5 inch, diameter of 4 ± 2 inch
- 6.3 *Graduate* – A conical or cylindrical shape graduate, 250 ml capacity
- 6.4 *Brushes* – A stiff wire brush and a soft bristle brush
- 6.5 *Container* – A small sample container with a secure and easily removable cover, at least 50 ml capacity
- 6.6 *Screen* – A shield used to protect the test area from air turbulence created from wind or traffic

7 Test Material Preparation

- 7.1 *Prepare one sample container for each test area location.*
 - 7.1.1 *Fill the graduate with 25 ± 2 ml of filler.*
 - 7.1.2 *Gently tap the side of the graduate to level the surface of the filler.*
 - 7.1.3 *Place the measured volume of filler in the container.*
 - 7.1.4 *Label the container with type and quantity of filler.*

8 Procedure

- 8.1 *Test Area*
 - 8.1.1 Randomly determine a test area location on the milled pavement surface in accordance with MT 606.
 - 8.1.2 Gently clean an area of about 1 foot by 1 foot for the test area location using the stiff wire brush to remove any, residue, debris or loosely bonded material. Be careful not to dislodge bonded material. After using the stiff wire brush, gently brush the test area location with the soft bristle brush to remove any remaining debris.
 - 8.1.3 Place the screen on the milled pavement surface to protect the test area location from air turbulence.

8.2 Test Measurement

- 8.2.1 Hold the container with filler no more than 4 inches above the pavement at the test area location.
- 8.2.2 Pour the measured volume of filler from the container onto the milled pavement surface into a conical pile.
- 8.2.3 Place the spreader lightly on top of the conical pile of filler being careful not to compact the filler.
- 8.2.4 Move the spreader in a slow, circular motion to disperse the filler in a circular area and to create a defined crest around the perimeter.
- 8.2.5 Continue spreading the filler until it is well dispersed and the spreader rides on top of the high points of the pavement surface.
- 8.2.6 Measure and record the diameter of the circular area four times, at intervals of 45° and to the nearest 0.1 inch, as shown in Figure 1.
- 8.2.7 Calculate the average diameter of the circular area covered by the filler (Equation 9.1).
- 8.2.8 Determine the macro-texture thickness of the milled pavement surface by using the cross reference table in Section 9.4 below.
- 8.3 Repeat Subsection 8.2 two more times.
- 8.4 Remove the filler material from the locations and properly dispose of the material.

9 Calculations

- 9.1 For each test area location, perform the following calculations.
- 9.1.1 Calculate the average diameter of the circular area covered by the filler.

$$Da = \frac{(D1 + D2 + D3 + D4)}{4}$$

Where:

Da = Average diameter of the filler area, inches

D1, D2, D3, D4 = Diameters of the filler area, inches

- 9.1.2 Calculate the area of the circle covered by the filler in square inches (in²).

$$A = \frac{\pi Da^2}{4}$$

- 9.1.3 Calculate the volume of filler in cubic inches (in³).

$$V(in^3) = \frac{V(ml)}{16.387 \text{ ml/in}^3}$$

- 9.1.4 Calculate Macro-texture Depth (inches):

$$Depth = \frac{V(in^3)}{A(in^2)}$$

9.1.5 Example:

Da = 8.0 inches

Area = $\pi Da^2/4 = \pi 8.0^2/4 = 50.265 \text{ in}^2$

Volume of filler = 25 ml

Convert ml to cubic inches = $25/16.387 = 1.525 \text{ in}^3$

Depth = $V(\text{in}^3)/A(\text{in}^2) = 1.525 \text{ in}^3/50.265 \text{ in}^2 = 0.030 \text{ in.}$

9.2 Calculate the Average Texture Depth (ATD)

9.2.1 Add the three (3) individual macro-texture depth results and divide by three.

9.2.2 Report the ATD to the nearest 0.001 inches.

9.3 Macro-Texture Thickness Based on 200 ml of Filler and Average Diameter

Average Diameter (inches)	Macrotexture Thickness (inches)	Average Diameter (inches)	Macrotexture Thickness (inches)	Average Diameter (inches)	Macrotexture Thickness (inches)
7.1	0.308	8.8	0.201	10.5	0.141
7.2	0.300	8.9	0.196	10.6	0.138
7.3	0.292	9.0	0.192	10.7	0.136
7.4	0.284	9.1	0.188	10.8	0.133
7.5	0.276	9.2	0.184	10.9	0.131
7.6	0.269	9.3	0.180	11.0	0.128
7.7	0.262	9.4	0.176	11.1	0.126
7.8	0.255	9.5	0.172	11.2	0.124
7.9	0.249	9.6	0.169	11.3	0.122
8.0	0.243	9.7	0.165	11.4	0.120
8.1	0.237	9.8	0.162	11.5	0.117
8.2	0.231	9.9	0.159	11.6	0.115
8.3	0.226	10.0	0.155	11.7	0.113
8.4	0.220	10.1	0.152	11.8	0.112
8.5	0.215	10.2	0.149	11.9	0.110
8.6	0.210	10.3	0.146	12.0	0.108
8.7	0.205	10.4	0.144	12.1	0.106

9.4 Macro-Texture Depth Based on 25 ml of Filler and Average Diameter

Average Diameter (Inches)	Macrotexture Depth (Inches)	Average Diameter (Inches)	Macrotexture Depth (Inches)	Average Diameter (Inches)	Macrotexture Depth (Inches)	Average Diameter (Inches)	Macrotexture Depth (Inches)
5	0.078	6.5	0.046	8	0.030	9.5	0.022
5.1	0.075	6.6	0.045	8.1	0.030	9.6	0.021
5.2	0.072	6.7	0.043	8.2	0.029	9.7	0.021
5.3	0.069	6.8	0.042	8.3	0.028	9.8	0.020
5.4	0.067	6.9	0.041	8.4	0.028	9.9	0.020
5.5	0.064	7	0.040	8.5	0.027	10	0.019
5.6	0.062	7.1	0.039	8.6	0.026	10.1	0.019
5.7	0.060	7.2	0.037	8.7	0.026	10.2	0.019
5.8	0.058	7.3	0.036	8.8	0.025	10.3	0.018
5.9	0.056	7.4	0.035	8.9	0.025	10.4	0.018
6	0.054	7.5	0.035	9	0.024	10.5	0.018
6.1	0.052	7.6	0.034	9.1	0.023	10.6	0.017
6.2	0.050	7.7	0.033	9.2	0.023	10.7	0.017
6.3	0.049	7.8	0.032	9.3	0.022	10.8	0.017
6.4	0.047	7.9	0.031	9.4	0.022	10.9	0.016

METHOD OF SAMPLING AND TESTING
MT 316-04
METHOD OF SAMPLING RECYCLED PAVEMENT
AND FIELD CONTROL OF RECYCLE PAVING

1 General

- 1.1 This method is divided into four sections which are as follows:
- 1.2 Section A: Sampling pavement for Cold Recycling
- 1.3 Section B: Field Control of Cold Recycle Paving
- 1.4 Section C: Sampling Pavement for Hot Recycling
- 1.5 Section D: Field Control of Hot Recycle Paving

Each section of this method is to be used specifically for its respective purpose related to recycle paving.

SECTION A

2 Sampling Pavement for Cold Recycling

- 2.1 Scope
- 2.2 This section describes the procedure for sampling roadways for cold mix recycling. The first portion describes sampling procedures for design information to determine if recycling is possible. The second portion describes sampling procedures for mix design purposes.

3 Procedure

- 3.1 Preliminary Sampling for Proposed Recycled Pavement
 - 3.1.1 The project should be divided into at least three areas from which milled or cored samples are obtained. A minimum of three representative sample locations should be visually selected in each area. Samples weighing approximately sixty pounds and representative of the lifts to be recycled should be obtained from each location. If maintenance patches or other intermittent treatments occur within the area, the locations that samples were taken should be recorded and the samples properly labeled. The proposed depth for recycling the pavement should be recorded.
 - 3.1.2 Sampling a Cold Recycled Pavement for Mix Design: Milled Sampling
 - 3.1.2.1 The project should be divided into at least three areas from which samples are obtained. A minimum of three locations should be used for each area of sampling. Submit approximately one hundred pounds of milled plant mix from each location. Three core samples should be taken to correspond with each milled area. The core samples should be placed into sealed containers at the job site so that in-place moisture contents may be determined.
 - 3.1.3 Submitting Samples
 - 3.1.3.1 Samples from different locations are to be kept separate and submitted to the Materials Bureau for testing. Pertinent information such as locations at which samples were taken and depth to which milling was performed should be submitted with the samples.

SECTION B

4 Field Control of Cold Recycle Paving

4.1 Scope

- 4.1.1 This section describes the procedure for field control of cold recycle paving. The test procedure utilizes standard 50 blow Marshall specimens. The Marshall specimens will be fabricated at the job site and then transported to the Materials bureau for compression testing.
- 4.1.2 Material should be secured from either the feed hopper of the laydown machine or the windrow, depending on the paving operation. Enough material (at least 25 lbs.) should be obtained for both the molding of briquettes and moisture determination.

5 Procedure

5.1 Determination of Moisture Content

- 5.1.1 For moisture determination, a representative sample of 2000 grams shall be weighed and placed in a 140°F oven.
- 5.1.2 The sample shall be weighed at intervals with weight losses recorded until a stabilized condition is achieved. A moisture loss of less than 1.0 gram in one hour should be considered a stabilized condition. Moisture content may be determined by:

$$\text{Moisture Content (\%)} = \frac{WT(\text{Initial}) - WT(\text{Final})}{WT(\text{Final})} \times 100\%$$

5.2 Briquette Fabrication

5.2.1 Apparatus

5.2.1.1 Scoops

5.2.1.2 Thermometer, - 50° to 150°F

5.2.1.3 Balance – 2 kg. Capacity for weighing batch samples and briquettes

5.2.1.4 Mixing spoons

5.2.1.5 Spatulas

5.2.1.6 Standard Marshall compaction pedestal – with molds and compaction hammer

5.2.1.7 Extrusion jack

5.2.1.8 Gloves and marking crayons

5.2.1.9 Pans for holding and warming specimens

5.2.1.10 Oven – capable of maintaining 140°F ±5°F

6 Preparation of Test Specimens

6.1 Prepare three specimens for each test.

- 6.2 Thoroughly clean molds and hammer face. Place paper disk in bottom of molds. Warm molds and hammer to remove chill.

- 6.3 Weigh out individual briquette samples. It is recommended that a trial briquette, approximately 1140 grams, be molded initially to determine height. Weight of material should then be adjusted to produce 2-1/2" ±0.05" specimens.
- 6.4 Warm individual specimens in 140°F oven for two hours. Note: This process has been found to develop a density of mix equal to the roller compaction on the roadway.
- 6.5 Mold briquettes using standard Marshall procedures (i.e., 50 blows applied to each face).
- 6.6 Curing specimens in molds for up to 24 hours before extruding may be necessary if distortion occurs at an earlier extrusion time. Molds should be placed on their sides to permit equal ventilation of both ends (remove paper disks).
- 6.7 Carefully extrude specimens from molds.
- 6.8 If, when extruded, briquettes are sufficiently strong to enable handling, proceed to weigh in air, weigh in water and weigh saturated surface dry.
- 6.9 If, when extruded, briquettes are too tender to handle, curing will be required until they can be handled. The bulk specific gravities may then be determined.

Bulk specific gravity is calculated as follows:

$$\text{BulkSpecificGravity (BSG)} = \frac{WT_{inAir}}{WT_{(SSD)} - WT_{inWater}}$$

- 6.9 Once bulk specific gravities have been determined, carefully transport the specimens to the Materials Lab for compression testing.
- 6.10 Report the specific gravities that were measured and the location represented by the samples. The samples must be protectively wrapped for shipping and they must be numbered sequentially to maintain control of their origin and history.

7 Utilization of Final Record Samples

- 7.1 The final record pavement core samples taken in accordance with MT 602 are designated for research. As soon as possible, these should be sent to the Materials Bureau, accompanied by Form No. 31. The location and sample number are to be entered on the form and the wrapped cores are to be sequentially numbered.

SECTION C

8 Sampling Pavement for Hot Mix recycling

- 8.1 Scope
- 8.1.2 This section describes the procedure for sampling roadways for hot mix recycling. The first portion describes sampling procedures for design information to determine if recycling is possible. The second portion describes sampling procedures for mix design purposes.

9 Procedure

- 9.1 Preliminary Sampling for Proposed Recycled Pavement:

- 9.1.2 The project should be divided into at least three areas from which milled or cored samples are obtained. A minimum of three representative sample locations should be visually selected in each area. Samples weighing approximately sixty pounds and representative of the lifts to be recycled should be obtained from each location. If maintenance patches or other intermittent treatments occur within the area, the locations that samples were taken from should be recorded and the samples properly labeled. The proposed depth for recycling the pavement should be recorded.

To complete assessment of a potentially recyclable pavement, submit information about sources of aggregate used on the original project. In addition, send a minimum of 350 pounds of material to the Materials Bureau from a source which may be used as a virgin aggregate in the recycle mix.

10 Sampling a Hot Recycled Pavement for Mix Design

10.1 Milled Sampling:

- 10.1.1 The project should be divided into at least three areas from which samples are obtained. A minimum of three locations should be used for each area of sampling. Submit approximately one hundred pounds of milled plant mix from each location. Three core samples should be taken to correspond with each milled area.

11 Stockpile Sampling

- 11.1 Stockpiles of crushed reclaimed plant mix shall be sampled in accordance with MT 201, paragraph 10.

Note – Stockpile sampling requires particular care to avoid segregation. Samples should be taken from a near vertical face and should be secured by reducing the sample to 300-pounds by the quartering method or with a sample splitter. Due to the time required to extract and analyze the reclaimed plant mix, samples should be submitted as soon as one-third of the reclaimed mat stockpile has been produced.

- 11.2 To complete the mix design, 350 pounds of aggregate from the stockpiles of virgin aggregate, along with the appropriate forms, are required. The samples and documentation may be submitted when, in the judgment of the Project Manager, they are representative of the material to be incorporated into the recycled plant mix.

SECTION D

12 Field Control of Hot Recycle Paving

12.1 Scope

- 12.1.2 This section describes the procedure for field control of hot recycle paving.

13 Procedure

- 13.1 The crushed reclaimed material shall be sampled in accordance with MT 201, paragraph 11: "Production sample shall be taken not less than every four hours. The sample shall be sieved and the percentage of oversize recorded. One sample of approximately 15 pounds shall be taken and submitted to the Materials Bureau every three days."
- 13.2 The aggregate incorporated into the mix shall be subject to all of the controls of a normal plant mix operation. The output of the plant will be subjected to field control Marshall testing with the same frequency as a conventional mix.
- 13.3 Monitors of established production of recycled plant mix shall be taken the first three days and the first day of every week thereafter or until otherwise informed by the Materials Bureau.

13.4 The samples shall be placed in a new double paper bag with completed form No 98 inserted between the sacks to keep it clean. The bag should be securely tied and marked as to sample number, stationing, lane and lift. This same information shall be placed on each Daily Plant Mix Report. Several of these paper bags can be packed into a sample sack for transmittal to the laboratory. Care should be taken to see that no movement is possible, or broken bags and mixed samples will result.

14 Utilization of Final Record Samples

14.1 The final record pavement core samples taken in accordance with MT 602 are designated for research. As soon as possible, these should be sent to the Materials Bureau, accompanied by Form No. 31. The location and sample number are to be entered on the form and the wrapped cores are to be sequentially numbered.

METHODS OF SAMPLING AND TESTING
MT 319-17
DETERMINING THE ASPHALT BINDER CONTENT
OF PLANT MIX SURFACING (PMS) BY THE IGNITION METHOD
(Modified AASHTO T 308)

1 Scope

- 1.1 This test method covers the determination of asphalt binder content of Plant Mix Surfacing (PMS) mixtures by ignition at temperatures that reach the flashpoint of the binder in a furnace. The means of specimen heating may be the convection method or the direct infrared (IR) irradiation method.
- 1.2 The values in metric units are to be regarded as the standard.
- 1.3 This standard may involve hazardous materials, operations, and equipment. This standard does not purport to address all of the safety problems associated with its use. It is the responsibility of the user of this standard to consult and establish appropriate safety and health practices and determine the applicability of regulatory limitations prior to use.

2 Referenced Documents

AASHTO

- M 231 Weighing Devices Used in the Testing of Materials
- R 47 Reducing Samples of Hot Mix Asphalt (HMA) to Testing Size
- T 308 Determining the Asphalt Binder Content of Asphalt Mixtures by the Ignition Method
- T 329 Moisture Content of Asphalt Mixtures by Oven Method

MT Materials Manual

- MT 202 Sieve Analysis of Fine and Coarse Aggregates
- MT 303 Sampling Bituminous Paving Mixtures
- MT 320 Mechanical Analysis of Aggregate Recovered from Ignition Oven Burn

3 Summary of Test Method

- 3.1 The asphalt binder in the paving mixture is ignited using the furnace equipment applicable to the particular method. The asphalt binder content is calculated as the difference between the initial mass of the PMS and the mass of the residual aggregate. The asphalt content is expressed as mass percent of moisture-free mixture. This method may be affected by the type of aggregate in the mixture. Accordingly, to optimize accuracy, establish correction factors for asphalt binder and aggregate by testing a set of correction factor specimens for each type of PMS.

4 Significance and Use

- 4.1 This method can be used for quantitative determinations of asphalt binder content and gradation in PMS mixtures and pavement specimens for quality control, specification acceptance, and mixture evaluation studies. This method does not require the use of solvents. Use aggregate obtained by this test method for gradation analysis according to [MT 320](#).

5 Apparatus

Ensure equipment used meets the following requirements:

- 5.1 *Ignition furnace* – A forced air ignition furnace that heats the specimen by either convection method or direct IR irradiation method. Use a convection-type furnace capable of maintaining a temperature at 578°C (1072°F). Use a furnace containing an internal balance thermally isolated from the furnace chamber and accurate to 0.1 g. The balance must be capable of weighing a 3500 gram specimen in addition to the specimen baskets. A data collection system is included so that the weight can be automatically determined and displayed during the test. The furnace has a built in computer program to calculate change in mass of the specimen and provide for the input of a correction factor. The furnace chamber and basket dimensions must be adequate to

accommodate a specimen size of up to 3500 grams. The furnace provides an audible alarm and indicator light when the specimen mass loss does not exceed 0.01 percent of the total specimen mass for three consecutive minutes. The furnace door is equipped so that the door cannot be opened during the ignition test. The furnace must be vented into a hood or to the outside. The furnace is equipped with a fan capable of pulling the air through the furnace to expedite the test and to reduce the escape of smoke into the laboratory.

- 5.2 *Specimen basket(s)* – of appropriate size that allows the specimens to be thinly spread and allows air to flow through and around the specimen particles. Ensure sets with 2 or more baskets are nested. Completely enclose the specimen with screen mesh, perforated stainless steel plate, or other suitable material.

Note 1 – Screen mesh or other suitable material with maximum and minimum opening of 2.36 mm (No. 8) and 600 microns (No. 30), respectively, has been found to perform well.

- 5.3 *Catch Pan* – of sufficient size to hold the specimen basket(s) so that aggregate particles and melting asphalt binder falling through the screen mesh are caught.
- 5.4 *Oven* – capable of maintaining mix design compaction temperature.
- 5.5 *Balance* – of sufficient capacity and conforming to the requirements of AASHTO M 231, Class G2, for weighing specimen in basket(s).
- 5.6 *Safety Equipment* – face shield, high temperature gloves, a heat resistant surface capable of withstanding 650°C (1202°F) and a protective cage capable of surrounding the specimen baskets during the cooling period.
- 5.7 *Miscellaneous Equipment* – a pan larger than the specimen basket(s) for transferring specimen after ignition; spatulas, bowls, wire brushes, and other manufacturer’s equipment.

6 Sampling

- 6.1 Obtain samples of freshly produced PMS in accordance with [MT 303](#).
- 6.2 Obtain the test specimen by splitting a sample taken in accordance with AASHTO R 47.
- 6.3 If the mixture is not sufficiently soft to separate with a spatula or trowel, place it in a large flat pan or glass dish in an oven (conventional or microwave). Heat the specimen to separate. Excessive heat may cause asphalt drain down or oxidation to occur, altering the results.
- 6.4 The size of the test specimen is governed by the nominal-maximum aggregate size of the PMS and must conform to the mass requirement shown in Table 1. Ensure the specimen is no more than 400 grams greater than the minimum recommended specimen mass.

Note 2 – Large specimens of fine mixes tend to result in incomplete ignition of asphalt.

Table 1—Mass Requirements

Nominal Max Agg Size, mm	Sieve Size	Min Mass of Specimen, g
4.75	No. 4	1200
9.5	3/8 in.	1200
12.5	1/2 in.	2000
19.0	3/4 in.	2000
25.0	1 in.	3000
37.5	1 1/2 in.	4000

7 Test Procedure

7.1 Test Initiation:

- 7.1.1 For the convection-type furnace, preheat the ignition furnace to 538°C (1000°F) or as determined in ANNEX A4.1. Manually record the furnace temperature (set point) prior to the initiation of the test if the furnace does not record automatically.
- 7.1.2 For the direct IR irradiation-type furnace, preheat furnace to 420°C (788°F) or manufacturer's recommendation. Use the same burn profile as used during the correction factor determination.
- 7.2 Determine the moisture content of the specimen according to AASHTO T 329 at the beginning and middle of each production day and as needed.
- 7.3 Apply the correction factor for the specific mix to be tested as determined in ANNEX A1 in the ignition furnace.
- 7.4 Weigh and record the mass of the specimen basket(s) and catch pan (with guards in place) to the nearest 0.1 gram.
- 7.5 Prepare the specimen as described in Section 6. Place the specimen basket(s) in the catch pan. Evenly distribute the specimen in the specimen basket(s), taking care to keep the material away from the edges of the basket. Use a spatula or trowel to level the specimen.
- 7.6 Weigh and record the total mass of the specimen, basket(s), catch pan, and basket guards. Calculate and record the initial mass of the specimen (total mass minus the mass of the specimen basket assembly).
- 7.7 Input the initial mass of the specimen to 0.1 gram for direct IR irradiation-type furnace or 1 gram for convection-type furnace into the ignition furnace controller. Verify that the correct mass has been entered.
- 7.8 Open the chamber door and place the specimen basket assembly in the furnace, carefully positioning the specimen basket assembly so it is not in contact with the furnace walls. Close the chamber door, and verify that the specimen mass (including the basket assembly) displayed on the furnace scale equals the total mass recorded in Section 7.6 within ± 5 grams. (Note 4). An indication that the specimen basket assembly is contacting the furnace wall is a difference greater than 5 g or failure of the furnace scale to stabilize.

Initiate the test by pressing the start/stop button. This operation will lock the specimen chamber and start the combustion blower.

Note 3 – The furnace temperature will drop below the set point when the door is opened, but will recover with the door closed and when ignition occurs. Specimen ignition typically increases the temperature well above the set point, depending on specimen size and asphalt binder content.

Note 4 – The weights obtained from external weighing take precedence over those obtained from the internal balance.

- 7.9 Allow the test to continue until the stable light and audible alarm indicate the test is complete (the change in mass does not exceed 0.01 percent for three consecutive minutes). Press the start/stop button. This will unlock the specimen chamber door.
- 7.10 Open the chamber door, remove the specimen basket assembly, allow specimen to cool to room temperature and weigh. During cooling, ensure specimen basket assembly is protected from contaminants.

- 7.11 Calculate the corrected asphalt binder content (percent) from the external weighing according to the following equation:

$$Pb, \% = \left[\frac{(M_i - M_f)}{M_i} \times 100 \right] \pm Cf - MC$$

Where:

Pb = the measured (corrected) asphalt binder content, percent

Mi = the total mass of the PMS specimen prior to ignition, g

Mf = the total mass of aggregate remaining after the ignition, g

Cf = the correction factor, percent by mass of PMS specimen

MC = the moisture content of the PMS

8 Extraction of Residual Aggregate for Gradation

- 8.1 Cool the contents of the specimen baskets to room temperature prior to performing the gradation analysis. Empty the contents of the baskets into a flat pan, being careful to capture all the material. Use a small wire sieve brush to ensure that any residual fines are removed from the baskets and catch pan.
- 8.2 Weigh the specimen and perform the gradation analysis according to [MT 320](#).

9 Report

- 9.1 Report the corrected asphalt binder content to the nearest 0.01%, correction factor, temperature compensation factor (if applicable), total percent loss, specimen mass and moisture content (if determined).

ANNEX**A1 Correction Factors**

- A1.1 Asphalt binder content results may be affected by the type of aggregate in the mixture and the ignition furnace. Accordingly, to optimize accuracy, establish a correction factor by testing a set of correction factor specimens for each type of PMS. Perform this procedure before any acceptance testing is completed. Repeat the process for determining a correction factor each time there is a new or transferred PMS design. Determine a unique correction factor for each ignition furnace in the location where testing is to be performed.
- A1.2 Asphalt binder correction factor – Certain aggregate types may result in unusually high correction factors (greater than 1.0 percent). Such mixes must be corrected and tested at a lower temperature, as described below. Determine a unique asphalt binder correction factor for each ignition furnace in the location where testing will be performed.
- A1.3 Aggregate correction factor – Due to potential aggregate breakdown during the ignition process, determine a unique aggregate correction factor for each ignition furnace in the location where testing will be performed when the following conditions occur: aggregates that have a proven history of excessive breakdown; or aggregates are from an unknown source.

A2 Correction Factor Procedure

- A2.1 According to the requirements of Section 6, prepare a minimum of four correction specimens at the job mix formula design asphalt content and gradation using only virgin material in a buttered bowl. Sample aggregate used for the correction factor specimens from stockpiled material produced and designated for use on the candidate project. An additional “blank” (aggregate only) specimen is provided for aggregate gradation comparison according to [MT 320](#). The washed gradation must fall within the mix design tolerances.
- A2.2 Place the freshly mixed specimens directly in the specimen baskets assembly. If allowed to cool, heat the specimens in a conventional oven to compaction temperature. Do not preheat the specimen baskets assembly.
- A2.3 Test the specimens in accordance with Sections 7 and 8.
- A2.4 After burning the appropriate number of calibration specimens, determine the measured asphalt binder contents for each specimen by calculation or from the printed tickets.
- A2.5 If the difference between the measured asphalt binder contents of the 2 specimens exceeds 0.15 percent, repeat the 2 tests and, from the 4 tests, discard the high and low results. Determine the correction factor from the 2 remaining results. Calculate the difference between the actual and measured asphalt binder contents for each specimen. The correction factor is the average of the differences expressed in percent by weight of the asphalt mixture.

A3 Correction Factor Ignition Oven Temperature Adjustment

- A3.1 For the convection-type furnace, if the correction factor exceeds 1.0 percent, lower the test temperature to $482 \pm 5^{\circ}\text{C}$ ($900 \pm 8^{\circ}\text{F}$) and repeat test. Use the correction factor obtained at 482°C ($900 \pm 8^{\circ}\text{F}$) even if it exceeds 1.0 percent.
- A3.2 For the direct irradiation-type furnace, use Option 2 burn profile for most materials. Option 1 is designed for very soft aggregate (such as dolomites) that typically require a large aggregate correction factor (greater than 1%). Option 2 is designed for specimens that may not burn completely using the DEFAULT burn profile and is appropriate for most of Montana aggregates.

A4 Procedure Temperature

- A4.1 For the convection-type furnace, the temperature for testing PMS specimens in Section 7.1.1 is the same temperature selected for testing mixture correction specimens.
- A4.2 For the direct IR irradiation-type furnace, the burn profile for testing PMS specimens in Section 7.1.2 is the same burn profile selected for testing mixture correction specimens.

A5 Aggregate Correction Factor

- A5.1 Perform a gradation analysis on the residual aggregate in accordance with [MT 320](#). Utilize the results to develop an aggregate correction factor. Calculate and report to the nearest 0.1 percent.
- A5.2 From the gradation results, subtract the percent passing for each sieve for each specimen from the percent passing each sieve of the “blank” specimen gradation results from Section A2.1.
- A5.3 Determine the average difference for the 2 values. If the difference for a single sieve exceeds the allowable difference for that sieve as listed in Table A1, apply aggregate gradation correction factors (equal to the resultant average differences) for all sieves, to all acceptance gradation test results determined by [MT 320](#), prior to final rounding and reporting. If the 0.075-mm (No. 200) sieve is the only sieve outside the limits in Table A1, apply the aggregate correction factor to only the 0.075-mm (No. 200) sieve.

Table A1 – Permitted Sieving Difference

Sieve Size	Allowable Difference
Sizes larger or equal to 2.36 mm (No. 8)	±5.0%
Sizes larger than 0.075 mm (No. 200) and smaller than 2.36 mm (No. 8)	±3.0%
Sizes 0.075 mm (No. 200) and smaller	±0.5%

A6 [Burn Oven Worksheet](#)

METHODS OF SAMPLING AND TESTING
MT 320-17
MECHANICAL ANALYSIS OF AGGREGATE RECOVERED FROM IGNITION OVEN BURN
(Modified AASHTO T 30)

MT 320 is identical to AASHTO T 30 except for the following stipulations:

1. Replace Table 1 with the following:

Table 1 – Maximum Allowable Mass of Material Retained on a Sieve

Screen Size	8-inch (203 mm) Diameter Screen		12-inch (304.8 mm) Diameter Screen	
	Maximum Grams	Maximum Pounds	Maximum Grams	Maximum Pounds
1 ¼-inch (31.75 mm)			3821.9	8.4
1-inch (25.0 mm)			3057.5	6.7
¾-inch (19.0 mm)			2598.9	5.7
⅝-inch (16.0 mm)			2293.2	5.1
½-inch (12.5 mm)			1987.4	4.4
⅜-inch (9.5 mm)			223.0	2.7
No. 4 (4.75 mm)			318	0.7
No. 8 (2.36 mm)	194	0.4	436.5	0.9
No. 10 (2.00 mm)	194	0.4	436.5	0.9
No. 16 (1.18 mm)	194	0.4	436.5	0.9
No. 30 (0.600 mm)	194	0.4	436.5	0.9
No. 40 (0.425 mm)	194	0.4	436.5	0.9
No. 50 (0.300 mm)	194	0.4	436.5	0.9
No. 80 (0.180 mm)	194	0.4	436.5	0.9
No. 100 (0.150 mm)	194	0.4	436.5	0.9
No. 200 (0.075 mm)	194	0.4	436.5	0.9

Note – If the sample is overloading screens, split or quarter the sample in accordance with [MT 607](#), Procedure for Reducing Field Samples of Aggregate to Testing Size. Grade each part of the sample separately and combine the weights to obtain a representative gradation. Use the following table to determine if screens are overloaded.

METHOD OF SAMPLING AND TESTING
MT 321-17
DETERMINING THEORETICAL MAXIMUM SPECIFIC GRAVITY
OF BITUMINOUS PAVING MIXTURES - "RICE GRAVITY"
(MODIFIED AASHTO T 209)

1 Scope

- 1.1 This test method covers the determination of theoretical maximum specific gravity (commonly referred to as Rice Gravity) of un-compacted bituminous paving mixtures.

2 Referenced Documents

AASHTO

T 209 Theoretical Maximum Specific Gravity and Density of Hot Mix Asphalt (HMA)

MT Materials Manual

MT 303 Sampling Bituminous Paving Mixtures

MT 309 Splitting Samples of Plant Mix Surfacing to Testing Size

MT 325 Determining Moisture Content of Bituminous Mixtures or Aggregate Using Microwave Ovens

3 Terminology

- 3.1 Residual pressure (as employed by this test method) – the pressure in a vacuum vessel when vacuum is applied.
- 3.2 Specific gravity (as determined by this test method) – the ratio of a given mass of material at 77°F (25°C) to the mass of an equal volume of water at the same temperature.

4 Significance and Use

- 4.1 The theoretical maximum specific gravities of bituminous paving mixtures are basic properties whose values are influenced by the composition of the mixtures and types and amounts of aggregates and asphalt materials.
- 4.2 These properties are used to calculate percent air voids in compacted bituminous paving mixtures.
- 4.3 These properties provide target values for the compaction of bituminous paving mixtures.
- 4.4 These properties are essential when calculating the amount of asphalt binder absorbed by the internal porosity of the individual aggregate particles in bituminous paving mixtures.

5 Apparatus

Ensure equipment used meets the following requirements:

- 5.1 *Balance* – Capacity of 16,000 g sensitive to 0.1 g, to allow the maximum specific gravity of the un-compacted mix to be calculated to the nearest thousandth (0.001 g).
- 5.2 *Container* – 4000 mL volumetric flask. Ensure the flask, with a proper cover (see Note 1), is sufficiently strong to withstand a partial vacuum. Confirm the top surfaces of all containers are smooth and substantially plane.

Note 1 – MDT uses a glass capillary stopper.

5.3 *Vacuum System*

5.3.1 *Vacuum Pump* – Motor driven vacuum pump, capable of maintaining at least 25 mm of Hg of vacuum. The pump is used for removing air from the flask through the vacuum.

5.3.2 *Vacuum Apparatus* - rubber stopper with a hose connection to connect the volumetric flask to vacuum pump.

5.3.3 *Vacuum Measurement Device* – Residual pressure manometer or vacuum gauge connected directly to the vacuum vessel and capable of measuring residual pressure down to 25 mm of Hg or less.

5.4 *Water Bath* – Water bath capable of maintaining constant temperature of $77 \pm 1^\circ\text{F}$ ($25 \pm 0.6^\circ\text{C}$) to fill the 4000 mL flask.

5.5 *Thermometer* – Liquid-in-glass thermometer accurate to 0.5°C (1°F).

6 **Sampling**

6.1 Obtain field samples in accordance with [MT 303](#). Split field samples in accordance with [MT 309](#).

6.2 Meet the sample size requirements in Table 1.

Table 1 – Minimum Sample Sizes

Nominal Maximum Aggregate Size	Minimum Sample Size
1" (25 mm)	2500 g (5.50 lb)
3/4" (19 mm)	2000 g (4.40 lb)
1/2" (12.5 mm)	1500 g (3.30 lb)
3/8" (9.5 mm)	1000 g (2.20 lb)
No. 4 (4.75 mm)	500 g (1.10 lb)

7 **Standardization of Flasks**

7.1 At the beginning of PMS production, the volumetric flask and glass capillary stopper are standardized to accurately determine the mass of water at $77 \pm 1^\circ\text{F}$ ($25 \pm 0.6^\circ\text{C}$) in the flask.

7.1.1 Fill the flask with water. Gently place the stopper in the flask ensuring proper seating. Ensure all air has been removed from the flask. Remove flask from water bath. Carefully towel dry the outside of the flask and stopper area. Weigh the flask with stopper and record the mass. Designate this mass as **E₁**, **E₂**, or **E₃**.

7.1.2 Remove the stopper and decant a portion of the water back into the bath. Repeat Section 7.2 two (2) more times.

7.1.3 Record the average of the flask standardization masses (See section 9.1). Designate this average mass as **E**.

7.2 Check standardization daily when testing and re-standardize as needed or when there is a change in tester, equipment, or when adding additional water for the day's testing. Keep the equipment clean and free from any accumulation that would change the mass if the volume standardization is to remain constant. Do not subject glass vessels to vacuum if they are scratched or damaged.

8 **Procedure**

8.1 Obtain a sample size in accordance with section 6.2, Table 1.

- 8.2 Separate the particles of the sample, taking care not to fracture the mineral particles so that the fine aggregate portion is not larger than ¼ inch.
- 8.3 The sample may be heated at mix design compaction temperature if necessary to facilitate the breakup of the sample.
- 8.4 Cool the sample to approximately 77°F.
- 8.5 Remove flask from water bath containing enough water at 77°F to cover the sample by approximately 1 inch, towel dry the outside of the flask, and place on the scale. Record the mass of the flask and water, then tare the scale.
- 8.6 Add the sample to the tared flask ensuring both the sample and the flask are at $77 \pm 2^\circ\text{F}$ ($25 \pm 0.6^\circ\text{C}$). Weigh to the nearest 0.1g. Designate the mass of the sample as **D**.
- 8.7 Wet the mouth of the flask and seat the vacuum apparatus on the flask, to ensure a proper seal between the flask and the vacuum apparatus. Turn on the vacuum pump to remove entrapped air by subjecting the contents to a partial vacuum of 27.5 ± 2.5 Hg mm gauge pressure for 15 ± 2 minutes (See Note 2). Agitate the container and contents either continuously by mechanical device or manually by vigorous shaking at intervals of about 2 minutes.

Note 2 – The time the sample is under vacuum does not begin until the proper gauge pressure has been reached.

- 8.8 Turn off the vacuum pump, slowly open the release valve to allow the pressure to normalize, then remove the vacuum apparatus.
- 8.9 Fill the flask with water from the water bath ($77 \pm 2^\circ\text{F}$). Gently place the stopper in the flask ensuring proper seating and taking care not to introduce air into the sample. Place the flask and contents in the water bath and bring the contents to a temperature of $77 \pm 2^\circ\text{F}$ within 10 ± 1 min after completing the vacuum procedure. Check the temperature of the contents with the thermometer.
- 8.10 Remove flask from water bath. Carefully towel dry the outside of the flask and stopper area. Determine the mass of the flask filled with contents. Designate the mass of flask with water and sample as **C**.

9 Calculations

- 9.1 Calculate the average of the flask standardization masses as follows:

$$E = \left(\frac{E_1 + E_2 + E_3}{3} \right)$$

Where:

E = averaged mass of standardized flask, designated as mass of flask

E₁ = 1st flask standardization mass

E₂ = 2nd flask standardization mass

E₃ = 3rd flask standardization mass

- 9.2 Calculate the mass of the sample (dry mass) and mass of standardized flask:

$$F = D + E$$

Where:

F = mass of the sample (dry mass) and mass of standardized flask

D = mass of the sample (dry mass)

E = mass of flask

- 9.3 Calculate the volume of the sample as follows:

$$G = F - C$$

Where:

G = Volume of sample

F = mass of sample (dry mass) and flask (equation 9.2)

C = mass of the standardized flask with contents (water and saturated sample after vacuum procedure)

- 9.4 Calculate the "Rice Gravity" of the sample as follows:

$$R = \frac{D}{G}$$

Where:

R = Gmm = theoretical maximum specific gravity of the mixture, "Rice Gravity"

D = mass of the sample (dry mass)

G = volume of sample (equation 9.3)

10 Report

- 10.1 Report the theoretical maximum specific gravity of the mixture (Rice Gravity) to the nearest thousandth (0.001).

METHODS OF SAMPLING AND TESTING
MT 322-04
METHOD OF DETERMINING THE PERCENT OF ADHESION
OF BITUMINOUS MATERIALS TO AGGREGATE
(Montana Method)

1 Scope

- 1.1 This test is intended to evaluate the resistance of a bituminized mixture to its bituminous film removal by water.

2 Apparatus

- 2.1 *Drying oven* - capable of maintaining a temperature of 248° F (120° C).
- 2.2 Electric hot plate
- 2.3 Various mixing pans
- 2.4 Putty knife
- 2.5 *Balance* - with a capacity of 500 grams
- 2.6 ¼" wire screen
- 2.7 ½ gallon can
- 2.8 Water
- 2.9 "Red Devil" or equal paint shaker

3 Preparation of Sample

- 3.1 The proposed aggregate is mixed with bituminous materials, which may be Asphalt Cement or Liquid Asphalt, or Emulsified Asphalt. The preparation of the sample, depending upon the type of bituminous materials, is as follows:

3.2 Asphalt Cement or Liquid Asphalt

- 3.2.1 Approximately 150 grams of plus ¼" aggregate and a sufficient quantity of the appropriate bituminous material are heated in separate containers in an oven at 248 °F (120 °C).
- 3.2.2 After heating, the aggregate is mixed on a hot plate with just enough bituminous material to thoroughly coat the aggregate surfaces. Avoid overheating the mix, as evidenced by smoking asphalt. A metal pan and putty knife are used to accomplish the mixing. The mixture is oven cured at 250 °F (121 °C) for one hour, then stirred and left to cool at room temperature.

3.3 Emulsified Asphalt

- 3.3.1 The test procedure varies somewhat at the preliminary stage when an emulsified asphalt is used. Add a sufficient quantity of the appropriate emulsion to approximately 150 grams of dry, cool, plus ¼" aggregate and stir until the sample is completely covered. Excess emulsion is drained off on an elevated 4 Mesh wire screen. The mixture is oven cured at 250 °F (121 °C) for a period of one hour. If CRS-2 is used, the aggregate must be pre-wetted.

4 Procedure

- 4.1 After the aggregate-bituminous mixture has cooled or cured for the prescribed time, it is removed from the mixing pan or draining screen with a putty knife.

Note – In order to facilitate removal, the mixture may be removed from the mixing pan or draining screen after the receptacle has been heated on a hot plate for approximately three seconds.

- 4.2 The mixture is then immersed in a half-gallon can containing one quart of water at 49 to 73 °F (15 to 25 °C) for twenty-four hours.
- 4.3 At the end of the soaking period, the mixture is shaken in a "Red Devil" or other approved paint shaker for five minutes, after which it is carefully washed to remove any loose bituminous material, and placed on a doubled layer of paper toweling. The sample is spread evenly over an area approximately five inches in diameter so that the paper is not visible through the sample.

5 Evaluation

- 5.1 Evaluation of adhesion is made only after the aggregate is thoroughly dry. A visual estimate of the proportion of the surfaces remaining coated with bituminous material is made and the results expressed as percent adhesion.

METHODS OF SAMPLING AND TESTING
MT 328-14
ESTABLISHING FIELD TARGET DENSITY
FOR PLANT MIX SURFACING DENSITY CONTROL

1 Scope

- 1.1 This test method is the procedure for establishing the field target density for compaction control of bituminous mixtures.

2 Referenced Documents

MT Materials Manual

MT 321 Determining Theoretical Maximum Specific Gravity and Density of Bituminous Paving Mixtures – “Rice Gravity”

3 Procedure

- 3.1 Determine the maximum specific gravity of un-compacted bituminous paving mixtures in accordance with [MT 321](#).
- 3.2 When two (2) maximum specific gravities of field samples have been determined using [MT 321](#), average the results. Use the average for the field target Rice Gravity density. This target is effective retroactive to the start of plant mix production on the project.
- Maintain documentation of the Theoretical Maximum Specific Gravity and Density of Bituminous Paving Mixtures ([MT 321](#)) to determine the target density and all changes during the contract.
- 3.3 When four (4) field Rice Gravities are completed, average the four (4) test values. If a change of 0.5 pound per cubic foot (8.0 kg per cubic meter) or greater is calculated change, to the new average Rice Gravity. This change is effective at the time the last sample was obtained.
- Notify applicable Department personnel (e.g. Project Manager, Lab Supervisor, Lead Inspector) immediately of effective change with day, time and tonnage of the change.
- 3.4 As each additional field Rice Gravity is completed, add the results to the sum of the previous three (3) gravities and compute an average. If a change of 0.5 pound per cubic foot (8.0 kg per cubic meter) or greater is calculated from the last field target density, change to the new average Rice Gravity. This change is effective at the time the last sample was obtained.

**METHODS OF SAMPLING AND TESTING
MT 329-04
PROCEDURE FOR EVALUATING
PLANT MIX SURFACING FAILURES**

1 Scope

- 1.1 This method covers the step-by step procedure for evaluating a plant mix surfacing failure. The procedure calls for reviewing the types of plant mix failures and method for rating the distressed areas.
- 1.2 After determining the type and extent of the failure, further investigational requirements will include reviewing plant mix production records, visual analysis, deflection analysis, sampling analysis of plant mix, base and subgrade materials and surfacing design analysis. Based upon all the information and data gathered through this procedure, the causes, potential solutions and recommendations to correct the plant mix surfacing failures can be determined.

2 Visual Analysis

- 2.1 The first step in investigating a pavement failure is to perform a complete and comprehensive visual analysis of the entire project emphasizing the distressed areas in question.
- 2.2 Determine the approximate milepost and/or stationing and length of each of the distressed areas. The following is a list of pavement distress types and a rating system to be used for the distress.

PAVEMENT FAILURE RATING SYSTEM RATING

<u>FAILURE TYPE</u>	<u>Light</u>	<u>Moderate</u>	<u>Severe</u>
<u>Rutting</u>			
Rut Depth	0-1/2"	1/2 – 3/4"	3/4" & Greater
Rate of Rutting	0-1/8"/yr. None Visible	1/8 – 3/8"/yr.	3/8"/yr.& Greater
Lateral Movement Of Rut (Humping)			Visible Bulge
Cracking	Longitudinal Cracks In wheel paths (Load Associated)	Alligator or Block Cracking Tight	Alligator or Block Cracking Edges spaced – pieces loose or missing
*Stripping	Some asphalt material stripped	**Cores	**Cores
Ravelling	Fines removed from surface.	1st layer coarse aggregate removed	Pavement removed through one or more lifts.

*Any stripping should be noted.

**If the investigation requires plant mix cores, advanced stages of stripping will be determined at that time.

Note – If dual wheel ruts exist, they should be noted. Measurements should always be taken in both wheelpaths with a stringline stretched from centerline to the shoulder to obtain the measurements.

3 Report of Visual Analysis

- 3.1 A summary of the visual analysis should be written immediately after the investigation.

3.2 The report should include date, reviewer, project termini, and detailed information concerning each distressed area. This information should include but not be limited to approximate milepost or station, length, width, relationship to centerline, lane and type of distress. Also, photographs of the typical distress on the project should be included. In addition to recording the types of pavement distress referenced above, record any other problems that are visible (drainage, terrain, frost problems, dips or swells, etc.). Based upon this visual analysis, the course of action and investigational requirements can be determined.

3.3 Copies of the report shall be sent to the District Engineer and the Materials Bureau Chief.

4 Deflection Analysis

4.1 After the visual analysis report has been evaluated, the second step of this procedure will normally require Road Rater testing. The decision to have a Road Rate analysis will be determined based upon the visual analysis. When the decision has been made to use the Road Rater, the following are the steps that will be followed.

4.2 The Road Rater shall be used to determine the in-place strengths of each layer. An elastic modulus for each layer will be determined from the roadway deflections.

4.2.1 Deflection tests will be taken at 200-800 foot intervals throughout problem areas to determine the extent of the distress. In addition, the remainder of the project will be tested using the normal testing intervals (six tests per mile).

4.2.2 The deflection analysis will be reviewed for elastic modulus of each layer to determine the nature and extent of the problem. The required design overlay thickness analysis will then be performed.

5 Investigation Requirements

5.1 Determine the investigational requirements depending on the type and extent of the plant mix failure. The following is a list of the distress types and requirements for each:

Distress Type	*Investigation Required
Cracking – Alligator	(1)-(7)
Rutting & Shoving	(1)-(7)
Stripping – Underlying Courses	(1)-(7)
Ravelling – Surface	(1),(3),(4)
Segregation	(1),(3),(4)

6 Investigational Requirements

6.1 *Physical Data* (information already obtained)

- Location
- Weather
- Extent of Failure
- Photos

6.2 *Deflection Analysis* (information already obtained)

Road Rater testing – evaluate good and bad areas of the project.

6.3 *Production Records* (a review of construction reports)

Note – When reviewing the reports listed below, look for any abnormalities.

Example: The production records generated during construction should be reviewed to determine if any problems during construction can be related to the pavement failure. For example there may have been some density problems in the same area of the failure, late paving, etc.

- Mix Design
- Plant Reports
- Marshall Tests
- Aggregate Tests
- Compaction Tests
- Monitor Samples
- Project Diaries

6.4 *Core Samples* – Plant mix core samples shall be obtained and tested as follows:

Note – Lifts will be identified and tested separately.

- Tests
- Thickness
- Density
- Rice Gravity
- A.C. Content
- Gradation
- HP-GPC
- Abson Extraction – AC Penetration
- Petrographic – Geology

Other tests to be determined by the Materials Bureau at the time of testing.

7 Sampling In-Place Material

- R Value
- Liquid Limit and Plastic Index
- Moisture
- Gradation
- Proctor

8 Traffic Data

- Present ADL
- Accumulative ADL

9 Structural Properties

- Gravel Equivalency – Surfacing Design

10 Samples and Testing Required

10.1 Samples shall be taken so that the following tests and procedures can be run to evaluate the problem areas. The samples will be submitted to the Materials Bureau for testing unless otherwise specified.

11 Traffic Data

- 11.1 Traffic data will be requested from the Planning and Statistics Bureau by the Materials Bureau. This data will be used by the Road Rater and Surfacing Design Sections to determine if any structural deficiencies exist. If the traffic section in the Planning Bureau feels traffic data may not reflect the true 18 Kip axle loads, a site specific investigation should be conducted by them.

12 Structural Analysis - Surfacing Design

- 12.1 The surfacing Design personnel will check the design of the problem area based on the new "R" Values and the condition of the pavement structure in place.

13 Report

- 13.1 A summary of the sample tests and other investigational requirements will be submitted upon completion of all testing of all testing and analysis.

METHODS OF SAMPLING AND TESTING
MT 331-14
SAMPLING AND EVALUATING
STRIPPING PAVEMENTS
(Montana Method)

1 Scope

1.1 This test method describes the procedure for sampling cores. Cores are used to evaluate existing structure, materials, pavement condition, lift thicknesses, and potential milling depth.

2 Sampling Procedure

2.1 *4-Lane Roadway*

Take a minimum of one (1) core per ½ mile of roadway in each direction. Alternate cores between the outside wheel path of the driving lane and the outside wheel path of passing lane. Pavement displaying a high extent or severity of cracking or raveling, rutting greater than 1/3 inch, and excessive patches, may require modification to the sampling frequency and location. If available, record the Global Positioning System (GPS) coordinates of core.

2.2 *2-Lane Roadway*

A minimum of one (1) core per ½ mile of roadway, taken in the outside wheel path and in alternating lanes. Pavement displaying a high extent or severity of cracking or raveling, rutting greater than 1/3 inch, and excessive patches, may require modification to the sampling frequency and location. If available, record the GPS coordinates of core.

Example:

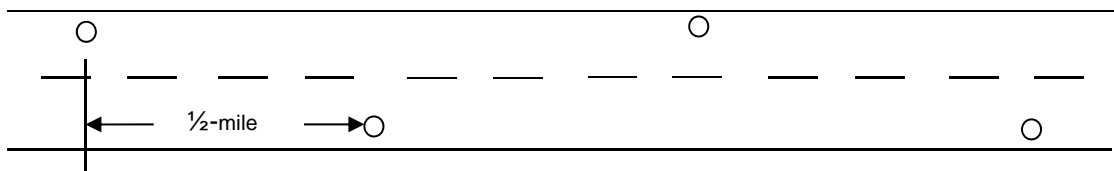

3 Sample Containment

3.1 Bag the cores with the bagging system provided by the Department’s Helena Materials Bureau. If possible, bag the core in the orientation it was extracted (directly from drill barrel). Keep field notes describing the appearance, location, and total depth of the core. Take pictures to accompany field notes. If a portion or portions of the core are rubble, describe the thickness of the rubble section and where the rubble portion was within the core. Submit the sample for stripping evaluation. Also describe the roadway condition and any other information that would be helpful in evaluating the cores and the in-place pavement.

4 Sample Identification and Submitting of Samples

4.1 Mark core with specimen number using a marker or grease pencil. Each core sample bag must contain a tag including the Sample Record ID number and specimen number. Ensure the Sample Record contains the Sample ID number, specimen number, uniform project number (UPN), and project name if available, location (route number, station, mile post, lane, offset, and GPS), total depth drilled and total length of the core when bagged. Submit the cores to the Materials Bureau for evaluation. Include observations and comments in the Sample Record Remarks.

5 Evaluation of Cores

5.1 Evaluate the **total** core for stripping using the "control photographs" in Annex A. Split cores by indirect tensile loading in a press and record maximum pressure needed to yield the core. Evaluate each lift or distinct layer of plant mix for stripping using the Core Rating Scale (Section 5.2).

5.2 Core Rating Scale

Core Rating	Description
4 (good core)	Face shiny, black, all aggregate particles coated
3 (moisture damaged)	Loss of sheen, dull appearance, some smaller aggregate is uncoated
2 (stripping)	In addition to moisture damage some large aggregate is not coated
1 (severely stripped)	Most of the aggregate is so clean the colors of the rock are easily seen
0 (no core)	Asphalt is mostly gone from all sizes of aggregate. The core has disintegrated.

6 Reporting Results

6.1 At the completion of the evaluation, test results consisting of the extent of stripping, and other test information are entered into SiteManager by the Materials Bureau. Each lift or layer is evaluated for stripping in the report.

ANNEX: EXAMPLES OF EVALUATED CORES

A1



GOOD CORE (4)
SHINY, BLACK
ALL AGGREGATE PARTICLES
ARE COATED

A2



MOISTURE DAMAGED (3)
LOSS OF SHEEN, DULL APPEARANCE
SOME SMALLER AGGREGATE (-10 M)
IS UNCOATED

A3



STRIPPING (2)
IN ADDITION TO MOISTURE
DAMAGE SOME LARGE AGGREGATE
IS NOT COATED

A4



SEVERLY STRIPPED (1)
MOST OF THE AGGREGATE IS
SO CLEAN THE COLORS OF THE
ROCKS ARE EASILY SEEN

A5



METHOD OF SAMPLING AND TESTING
MT 332-17
GYRATORY COMPACTION OF BITUMINOUS MIXTURES
(Modified AASHTO T 312)

MT 332 is identical to AASHTO T 312 except for the following additions:

- Section 11 – Include the following calculations.

% Air Voids (V_a)

$$V_a = 100 \times \left(\frac{G_{mm} - G_{mb}}{G_{mm}} \right)$$

Where:

G_{mm} = Maximum specific gravity of paving mixture (Rice)

G_{mb} = Bulk specific gravity of compacted mixture

Record and round to the nearest 0.1%

Voids in the Mineral Aggregate (VMA)

$$VMA = 100 - \left(\frac{G_{mb}(100 - P_s)}{G_{sb}} \right)$$

Where:

G_{mb} = Bulk specific gravity of compacted mixture

P_s = Aggregate content, percent by total mass of mixture

G_{sb} = Bulk specific gravity of aggregate

Record and round to the nearest 0.1%

Voids Filled with Asphalt (VFA)

$$VFA = 100 \times \left(\frac{VMA - V_a}{VMA} \right)$$

Record and round to the nearest 0.1%

Dust/Asphalt Ratio

$$DA = \left(\frac{P_{200} - 1}{P_b} \right)$$

Where:

DA = Dust to Asphalt Ratio,

P_{200} = Aggregate content passing the 0.075mm sieve, the percent by mass of aggregate ([MT 320](#))

P_b = Asphalt Content, percent by total mass of mixture ([MT 319](#))

Record and round to the nearest 0.1%

Note – The Dust/Asphalt ratio is used during mix design and field production.

Dust Proportion

$$DP = \left(\frac{P_{200} - 1}{P_{be}} \right)$$

Where:

DP = Dust Proportion,

P₂₀₀ = Aggregate content passing the 0.075mm sieve, the percent by mass of aggregate
(MT 320)

P_{be} = Effective asphalt content, percent by total mass of mixture

Note – The Dust Proportion is used during mix design.

Effective Asphalt Content

$$P_{be} = - (P_s \times G_b) \times \left(\frac{G_{se} - G_{sb}}{G_{se} \times G_{sb}} \right) + P_b$$

Where:

P_{be} = Effective asphalt content, percent by total mass of mixture

P_s = Aggregate content, percent by total mass of mixture

G_b = Specific gravity of asphalt

G_{se} = Effective specific gravity of aggregate

G_{sb} = Bulk specific gravity of aggregate

P_b = Asphalt Content, percent by total mass of mixture

Record and round to the nearest 0.1%.

METHODS OF SAMPLING AND TESTING
MT 333-04
METHOD OF TEST FOR THE TORSIONAL RECOVERY OF
LATEX MODIFIED ASPHALT EMULSION RESIDUE

1 Scope

- 1.1 This test method provides an indication of the amount of elasticity that has been imparted to asphalt by the addition of latex. The asphalt used in this test has been recovered from an emulsion.

2 Apparatus

- 2.1 *Sample container* – A flat-bottomed, cylindrical, seamless tin 55mm (2.17 inch) in diameter and 35 mm (1.38 inch) in depth. The container is commonly known as a 3-ounce ointment tin.
- 2.2 *Disc and spider assembly* – This assembly is shown in Figure 1. The disc is made of aluminum. The spider assembly, bolt, and pointer are made of steel.
- 2.3 *Wrench* – A 9/16 inch open-end or box wrench.
- 2.4 *Timer* – A stopwatch, clock, or other timing device graduated in divisions of one second or less.
- 2.5 *Scale* – A paper scale, graduated in millimeters, at least 180 mm in length.

3 Procedure

- 3.1 Place the spider assembly on the container and adjust it so that it is centered, using the small nuts on the arms of the spider to maintain the adjustment. Adjust the depth of the disc in the container so that the top of the disc will not be below the surface of the asphalt. Remove the spider assembly from the container. Construct two, centered spider assemblies and containers per test.
- 3.2 Obtain a latex modified asphalt residue sample by following the procedure outlined in AASHTO T 59, Residue By Evaporation, sections 21 – 27.
- 3.3 Transfer a sufficient quantity of the hot residue into the sample container to fill it to within ½ to ¼ inch from the top of the container. Immediately place the previously centered spider assembly on the container and adjust the depth of the disc to bring the top of the disc level with the surface of the asphalt.
- 3.4 Place the two test assemblies in a 138°C (280°F) oven for ten minutes to allow air bubbles to escape and the break the surface tension around the disc. Remove the assembly from the oven and allow cooling to room temperature for two hours.
- 3.5 Tape a paper scale around the container and mark the location of the pointer. Make another mark 180° from the pointer (halfway around the container).
- 3.6 Holding the container and spider assembly rigidly, place the wrench on the bolt head and turn the bolt to the 180° reference mark and release immediately. The rotation should be done at a steady rate and be accomplished in approximately 5 seconds. Start the stopwatch when the bolt is released. Mark the location of the pointer on the scale when 30 seconds have elapsed, and again when 30 minutes have elapsed. Repeat the procedure with the second test assembly.

4 Calculation and Report

4.1 The percent of recovery following deformation is calculated as follows:

$$\text{Percent Recovery} = \left[\frac{A}{\left(\frac{B}{2}\right)} \right] * 100$$

Where:

A = The arc on the container, measured in millimeters, between the mark made after 30 seconds has elapsed, and the mark made after 30 minutes has elapsed.

B = The circumference of the can, measured in millimeters.

4.2 Report the percent recovery as an average of the two tests.

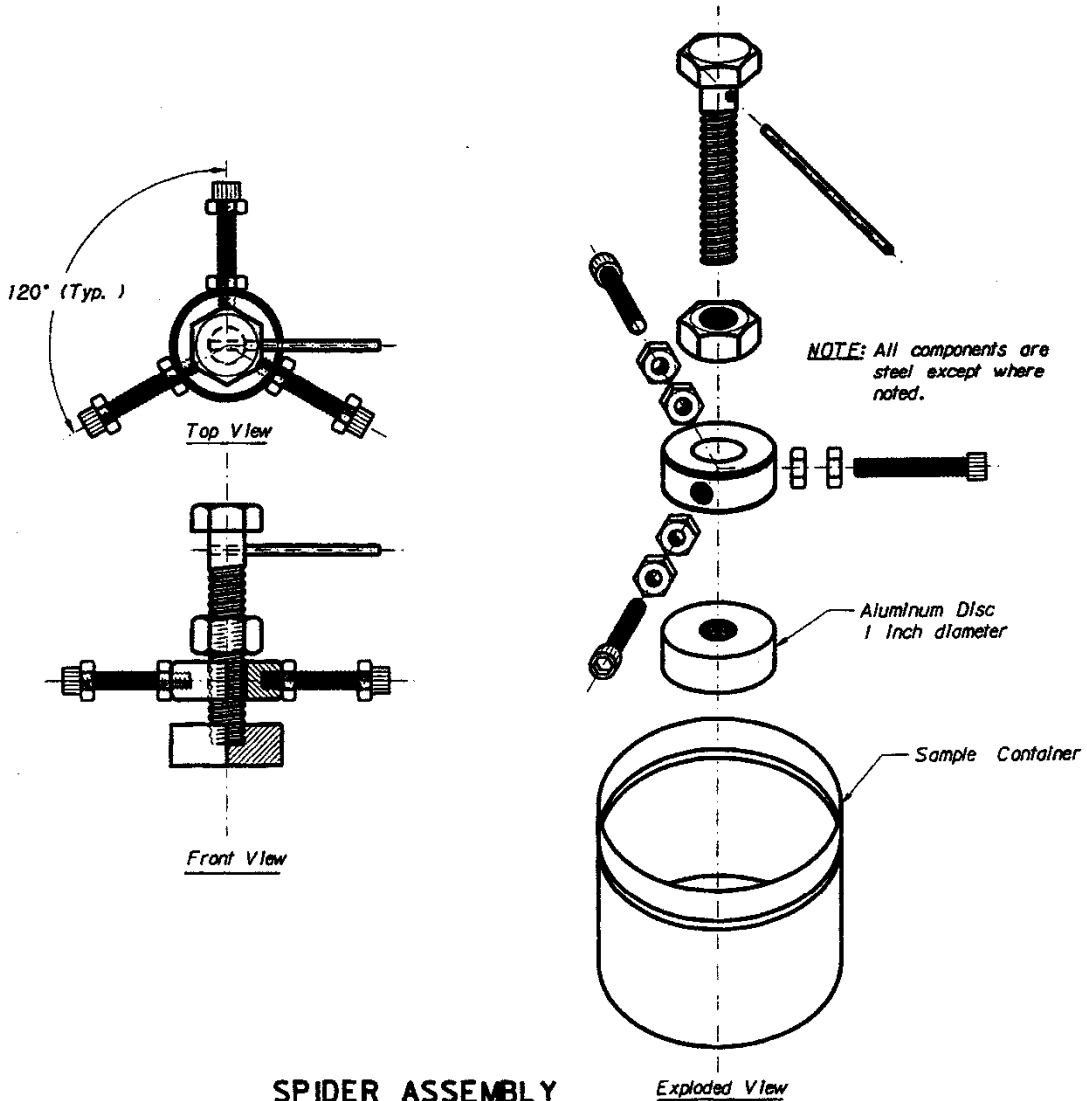

SPIDER ASSEMBLY
Scale ~ N. T. S.



FILENAME: Motor1gl.dgn

DATE: 8-3-00 D.G.C.

METHOD OF SAMPLING AND TESTING
MT 334-17
HAMBURG WHEEL-TRACK TESTING
OF COMPACTED BITUMINOUS MIXTURES
(Modified AASHTO T 324)

1 Scope

- 1.1 This test method describes a procedure for testing the rutting and moisture-susceptibility of plant mix surfacing (PMS) specimens in the Hamburg Wheel-Track Testing Device.
- 1.2 The method describes the testing of submerged, compacted PMS in a reciprocating rolling-wheel device. This test provides information about the rate of permanent deformation from a moving, concentrated load. This procedure utilizes laboratory- or field laboratory-compact specimens, field saw-cut slabs, or field cores.
- 1.3 The test method is used to determine the premature failure susceptibility of PMS due to weakness in the aggregate structure, inadequate binder stiffness, or moisture damage. This test method measures the rut depth and number of passes to failure.
- 1.4 The specimens are submerged in temperature-controlled water during loading to evaluate the potential for moisture damage effects.

2 Reference Documents**AASHTO**

- T 166 Bulk Specific Gravity (G_{mb}) of Asphalt Mixtures Using Saturated Surface-Dry Specimens
T 324 Hamburg Wheel-Track Testing of Compacted Asphalt Mixtures

MT Materials Manual

- MT 303 Sampling Bituminous Paving Mixtures
MT 321 Determining Theoretical Maximum Specific Gravity of Bituminous Paving Mixtures –
“Rice Gravity”
MT 332 Gyratory Compaction of Bituminous Mixtures
MT 335 Linear Kneading Compaction of Bituminous Mixtures

Manufacturer’s Operation Manual

For equipment used

3 Terminology3.1 *Specimen*

Any of the following are considered specimens under this test method.

- 3.1.1 Laboratory-compact slab
- 3.1.2 Two (2) paired laboratory-compact gyratory pucks
- 3.1.3 Two (2) paired field laboratory-compact gyratory pucks
- 3.1.4 Field core, 10” core or two (2) paired 6” cores
- 3.1.5 Field saw-cut slab
- 3.2 Mix Design Verification Test

A Mix Design Verification test will consist of evaluating two specimens with the Hamburg Wheel-Tracking Device and averaging the results.

3.3 Field Production Verification Test

A Field Production Verification test will consist of the evaluation of one specimen with the Hamburg Wheel-Tracking Device.

4 Summary of Method

- 4.1 A laboratory- or field laboratory-compacted specimen of PMS, a core(s) taken from compacted pavement, or a saw-cut slab specimen is repetitively loaded using a reciprocating steel wheel. The specimen is submerged in a temperature-controlled water bath at a temperature specified for the binder being used. The deformation of the specimen, caused by the wheel loading, is measured.
- 4.2 The impression is plotted as a function of the number of wheel passes. An abrupt increase in the rate of deformation coincides with stripping of the asphalt binder from the aggregate in the PMS specimen.

5 Apparatus

Ensure equipment used meets the following requirements:

- 5.1 *Hamburg Wheel-Track Testing Device* – Electrically powered device capable of moving a steel wheel with a diameter of 203.2 ± 2.0 mm (8 ± 0.08 in.) and width of 47 mm (1.85 in) over a test specimen. The load applied by the wheel is 705 ± 4.5 N (158 ± 1.0 lb.). The wheel load is maintained at $\pm 5\%$ for the duration of the test excluding the cycles that are interrupted by stopping the process. The wheel reciprocates over the specimen, with the position varying sinusoidally over time. The wheel makes 52 ± 2 passes across the specimen per minute.
- 5.2 *Temperature Control System* – Water bath capable of controlling the temperature within $\pm 2.0^\circ\text{C}$ over a range of 25 to 70°C (77 to 158°F). This bath should have a mechanical circulating system to stabilize the water temperature.
- 5.3 *Impression Measurement System* – Linear Variable Differential Transducer (LVDT) device capable of measuring the depth of the impression of the wheel within 0.5 mm, over a range of at least 0 to 20 mm. The system is mounted to measure the depth of the impression at several points, including the midpoint, in the wheel's path on the specimen. The impression is measured at least every 400 passes of the wheel without stopping the wheel.
- 5.4 *Wheel Pass Counter* – Device that counts each wheel pass over the specimen. The signal from this counter is coupled to the wheel impression measurement, allowing for the depth to be correlated with the number of wheel passes.
- 5.5 *Slab Specimen Mounting System* – A tray that is mounted to the machine so that movement of the specimen is restricted to less than 0.5 mm (0.02 in.) during testing. Plaster of paris may be used to rigidly mount specimen in tray. The system supports the specimen, allowing for free circulation of water in the bath on all sides of the specimen and tray.
- 5.6 *Cylindrical Specimen Mounting System* – An assembly consisting of two high-density polyethylene (HDPE) molds or plaster of paris to hold the gyratory pucks or cores, placed in a tray that is mounted to the machine so that movement of the specimen is restricted to less than 0.5 mm (0.02 in.) during testing. The system supports the specimen, allowing for free circulation of water in the bath on all sides of the specimen and tray.
- 5.7 *Balance* – Balance with a minimum capacity of 15,000 grams, accurate to 0.1 g.
- 5.8 *Oven* – Thermostatically-controlled forced draft or convection oven.
- 5.9 *Mixing apparatus* – Bowls, spoon, spatula, etc.
- 5.10 *Diamond Bladed Saw* – Capable of cutting PMS.

6 Specimen Preparation

- 6.1 *Number of Specimens* – Produce at least two (2) specimens for a Mix Design Verification test and one (1) specimen for a Field Production Verification test.
 - 6.2 *Laboratory Produced Mix* – Before mixing bituminous mixtures for testing, “butter” all of the pans and implements. Heat materials to the mixing temperature range in a forced draft or convection oven. Do not overheat the material.
 - 6.3 *Laboratory-Compacted Slabs* – Prepare PMS and compact into slabs in accordance with [MT 335](#). Slab thicknesses should be within a range of 38 to 100 mm. Ensure the slab thickness is at least twice maximum aggregate size. Determine the air void content of the slab.
 - 6.4 *Gyratory-Compacted Specimens* – Prepare PMS as necessary and compact into gyratory pucks in accordance with [MT 332](#). Determine the air void content of the gyratory pucks. Mark the compacted face of each gyratory puck and cut to height if necessary by removing the uncompacted face (Note 1). Cut each puck on a chord that is 35 to 45 mm longer than the width of the test wheel and parallel to the vertical axis of the specimen. Mount the two cut pucks so that the chords are together and the wheel rolls on the uncut faces of the pucks (see Note 2). The wheel path should follow the diameter of each half of the specimen through the center of the chords. A tolerance of ± 5 mm offset from the center is allowed.
- Note 1 - When using the Pine Brovold Gyratory Compactor (Model AFG1) the compacted face is the bottom face as the puck sits in the compactor so the puck must be flipped after extraction in order to mark the compacted face.*
- Note 2 – Take care when loading the specimen so it is level to the surface of the mold. Trim the specimen if it is too tall or shim it up if it is too short (support with bedding sand or plaster as needed).*
- 6.5 *Determine Air Void Content* – Determine the air void content of the compacted slab and gyratory compacted pucks in accordance with [MT 335](#) and [MT 332](#), respectively. The recommended target air void content is 7.0 ± 1.0 percent for laboratory-compacted slabs and 7.0 ± 0.5 percent for laboratory-compacted gyratory pucks. The air void content of field laboratory specimens will vary.
 - 6.6 *Field Cores* – One (1) – 10” core or two (2) – 6” cores. Cut field cores with an appropriately sized diameter bit. Remove the bottom lift(s) of PMS to achieve the desired height between 38 to 100 mm. Cut the core with a diamond saw at the desired point, taking care to orient the cut parallel to the surface being tested.

7 Procedure

- 7.1 Place specimens in mounting systems. Use plaster of paris to rigidly mount specimens (i.e., 10” cores) that don’t fit in the HDPE molds or trays.
- 7.2 Position the frame holding the specimen into the wheel-tracker so that the loading arm of the wheel is approximately horizontal when it rests on the slab. Ensure that the frame is securely fastened. Confirm that the settings of the machine are the same as those required for the specification. These settings include wheel force, appropriate water temperature based on binder grade (see [Table 1](#)), stroke length, speed and any other variables described in the procedure. Enter the number of test passes required by the specification.

Table 1

Binder Grade	Test Temperature
70-28	133°F (56°C)
64-22 and 64-28	122°F (50°C)
58-28	111°F (44°C)

- 7.3 Lower the wheel onto the slab. Select the “Start” button of the testing device software. When the specimen has been preconditioned in the water at the test temperature, for 45 minutes, the initial passes of the loaded wheel occur; this establishes zero. The wheel-tracking device shuts off when the test completes the specified number of passes, when the test has achieved the maximum impression depth established in the specification, or when the set maximum standard deviation has been reached. The testing device software automatically saves the test data file.
- 7.4 Photograph the tested specimen before removing specimen mounting tray, if possible; otherwise photograph the specimen after removing the mounting trays. Remove the specimen mounting tray(s) containing the specimen(s). Remove the specimen from the mounting tray and thoroughly clean the mounting tray(s). Clean the water bath, heating coils, wheels, filter element, spacers, and temperature probe in accordance with manufacturer’s recommendations. If no manufacturer’s recommendation exists, use water and scouring pads. Remove particles that have settled to the bottom of the baths. Lubricate moving parts in accordance with manufacturer’s recommendations. Do not use solvents to clean the water bath.
- 7.5 Report the Average Final Impression determined by the software as the Hamburg Wheel-Tracking Device test result. Determine the average impression of each run by averaging the middle seven points from the data given by the software (eliminating the first two data points and the last two data points). A Field Production Verification test consists of a single specimen. A Mix Design Verification test is the average of two or more specimens. If two Mix Design Verification specimens vary by more than 6 mm with one passing test result and one failing test result, prepare two more test specimens and re-run. The reported result will be the average of all four or more individual specimen test results.

8 Report

- 8.1 Ensure the report of the results contains the following information.

Sample, Compaction, and Run Dates

Project Number

Project Name

Tester/Technician

Binder Content

Contract Binder Grade

SiteManager Sample ID

Sample Type (Start-up; Target-set, Out-of-broadband, etc.; Informational Use Only)

Rice Gravity

Density

% Air Voids (include % Air Voids for each gyratory puck used in the specimen)

Other Comments

Configuration Settings

Conditioning Time

Velocity

Maximum Allowed Passes

Maximum Allowed Depth

Sample Frequency

Data Points

Wheel Travel

Water Temperature

Force Setting

Average Final Impression

Graph (number of passes on the x-axis and impression depth on the y-axis)

**METHOD OF SAMPLING AND TESTING
MT 335-14
LINEAR KNEADING COMPACTION OF
PLANT MIX SURFACING (PMS)**

1 Scope

- 1.1 This test method is used to prepare compacted slabs of PMS for testing with the Hamburg Wheel-Track Testing Devices.

2 Reference Documents**AASHTO**

- R 47 Reducing Samples of Hot Mix Asphalt (HMA) to Testing Size
T 166 Bulk Specific Gravity (Gmb) of Compacted Hot Mix Asphalt (HMA) Using Saturated Surface-Dry Specimens

MT Materials Manual

- MT 303 Sampling Bituminous Paving Mixtures
MT 321 Determining Theoretical Maximum Specific Gravity of Bituminous Paving Mixtures – “Rice Gravity”
MT 332 Gyrotory Compaction of Bituminous Mixtures
MT 334 Hamburg Wheel-Track Testing of Compacted Bituminous Mixtures

Manufacturer’s Operation Manual

For equipment used

3 Summary of Method

- 3.1 A slab of plant mix is compacted by applying pressure to the PMS through a series of rectangular parallel plates. The sample is placed in an open top steel box with the desired dimensions. Closely fitting steel plates are placed in a vertical row across the plant mix. A steel roller travels back and forth on the row of plates and successively applies pressure to the plant mix through the plates. This compacting motion continues until the height of the specimen of plant mix is reduced to the height calculated to yield the desired voids.

4 Apparatus

Ensure equipment used meets the following requirements:

- 4.1 *Linear Kneading Compactor* – Hydraulic powered unit, used to compact bituminous mixtures into rectangular slabs using vertically aligned steel plates that compress the bituminous mixture into a flat slab of predetermined thickness and density.
- 4.2 *Steel Wear Plate* – 10.125” wide, 12.6” long, 0.125” high
- 4.3 *Steel Compacting Plates* – 3.6” high
- 4.4 *Steel Compaction Carrier Box* – 10.25” wide, 12.625” long, 6” high
- 4.5 *Temperature Control System* – Oven which can maintain temperatures (250°F to 350°F).
- 4.6 *Shims* – Aluminum or steel plates that vary in thickness to achieve desired specimen height.
- 4.7 *Rubber Mallet*
- 4.8 *Balance* – Balance with a minimum capacity of 15,000 grams, accurate to 0.1 g.

5 Sample

- 5.1 *Field Specimens* – The top lift or lifts of PMS are tested. Ensure specimens for testing have a thickness at least two times the nominal maximum aggregate size.
- 5.1.1 *Slabs* –The formula for the volume of a slab is as follows: length x width x thickness. The amount of material to batch for each slab with $7 \pm 1\%$ air voids is determined by multiplying the specimen length x width x thickness in cubic centimeters by the specimen's maximum specific gravity (G_{mm}) x 0.93. Mass for sample = $5283 \text{ cm}^3 \times 1 \text{ gm/cm}^3 \times G_{mm} \times 0.93$
- 5.1.2 *Laboratory Produced Mix* – Before mixing bituminous mixtures for testing, “butter” all of the pans and implements. Heat materials to the mixing temperature range in a forced draft or convection oven. Do not overheat the specimens.

6 Procedure

- 6.1 Preheat wear and compaction plates in an oven to desired compaction temperature. Ensure PMS is heated to desired compaction temperature. If not, place in the oven to heat to compaction temperature.
- 6.2 Mix and reduce the sample in accordance with AASHTO R 47 to approximate sample sizes. Individually weigh enough material for each specimen.
- 6.3 Place the wear plate in compaction carrier box.
- 6.4 Load the specimen into compaction carrier box. Place the steel parallel plates vertically on top of the specimen mixture. To level plates on the specimen, use a rubber mallet if needed.
- 6.5 Ensure that all safety mechanisms are in place at Linear Kneading Compaction start-up in accordance with manufacturer's recommendations. Start the Linear Kneading Compactor.
- 6.5 Using a hydraulic jack, pressure will be applied automatically or manually to the specimen. Maintain a constant pressure until specimen reaches desired height. Ensure final compaction is $7 \pm 1\%$ air voids.
- 6.6 Press the stop button to complete the compaction process. Shut off the Linear Kneading Compactor and disengage safety mechanisms. Remove steel plates and side walls. Remove slab along with the bottom plate and cool to room temperature (to the touch).
- 6.7 Repeat the procedure for any additional specimens.

7 Calculation

- 7.1 Using AASHTO T 166 and [MT 321](#), calculate the air void content of the specimen to the nearest tenth of a percent.

% Air Voids (V_a)

$$V_a = 100 \times \left(\frac{G_{mm} - G_{mb}}{G_{mm}} \right)$$

Where:

G_{mm} = Maximum specific gravity of paving mixture (Rice)

G_{mb} = Bulk specific gravity of compacted mixture

Round and record to the nearest 0.1%

**CURRENT DATE OF REVISION
MT 400 SECTION
MISCELLANEOUS MATERIALS AND TEST METHODS**

<u>Test Method No.</u>	<u>Title</u>	<u>Pages</u>	<u>Date of Publication or Revision</u>
MT 401	Sampling and Inspecting Corrugated Aluminum Pipe	2 pp	May 2007
MT 402	Sampling and Testing Corrugated Steel Pipe.....	2 pp	Jun 2004
MT 403	Sampling and Inspection of Seeding and Landscaping Materials	3 pp	Jun 2004
MT 404	Inspecting Wood Products	1 pp	Jun 2004
MT 405	Wire Cloth Sieves for Testing Purposes	4 pp	Jun 2004
MT 406	Sampling and Inspection of Signing Material and Signs.....	5 pp	Jun 2004
MT 407	Method of Test for High Strength Bolts.....	4 pp	Sep 2005
MT 408	Method of Sampling and Field Testing Brine Deicing Material	3 pp	Feb 2010
MT 409	Welded Stud Shear Connectors.....		Under Development
MT 410	Inspection, Sampling, Testing and Acceptance of Paint.....	3 pp	Jun 2004
MT 411	Vacant		
MT 412	Topsoil Sampling, Sample Preparation and Testing.....	2 pp	Sep 2018
MT 413	Inspection of Fencing Materials	2 pp	Sep 2005
MT 414	Method of Acceptance for Reinforcing Steel.....	5 pp	Jun 2009
MT 415	Structural Steel.....		Under Development
MT 416	Vacant		
MT 417	Vacant		
MT 418	Method of Acceptance for Miscellaneous Welded Items	1 pp	Jun 2004
MT 419	Vacant		
MT 420	Procedure to Check for Leaks Under Hydrostatic Pressure	3 pp	Jun 2004
MT 421	Sampling Construction Fabrics	2 pp	Jun 2009
MT 422	Method of Test for Surface Smoothness and Profile	5 pp	Apr 2012

METHODS OF SAMPLING AND TESTING
MT 401-07
METHOD OF SAMPLING AND INSPECTING CORRUGATED ALUMINUM PIPE
(AASHTO M196, M197)

1 Scope:

- 1.1 This specification covers the testing and inspection guidelines for aluminum clad alloy culverts and underdrains.

2 Referenced Documents:

2.1 AASHTO:

M196 Corrugated Aluminum Pipe for Sewers and Drains
M 197 Aluminum Alloy Sheet for Corrugated Aluminum Pipe

ASTM:

B 209 Specification for Aluminum and Aluminum-Alloy Sheet and Plate

3 Sampling:

- 3.1 Sampling shall be performed or witnessed by the testing agency at the point of fabrication.
- 3.2 Random sampling shall consist of at least one set of three 1" x 12" samples per gauge, alloy and temper, lot number and type of corrugation. Samples shall be obtained a minimum of 3" from any edge.
- 3.3 Previously tested material that is properly marked and accepted need not be re-sampled but must be listed in the test report.
- 3.4 In the event that the samples fail to comply, two additional sets of three samples will be taken from the same gauge, alloy and temper, lot number and type of corrugation. Both sets must comply with the requirements or the entire lot number will be rejected.
- 3.5 Each corrugated sheet used in annular corrugated pipe, and each 2 ft. (0.6m) to 5 ft. (1.5m) of coiled sheet used in helically corrugated pipe, shall be identified by the fabricator showing the following:
- 3.5.1 Name of sheet manufacturer.
- 3.5.2 Identification of the pipe fabricator, if different than the sheet manufacturer.
- 3.5.3 Alloy and temper.
- 3.5.4 Specified thickness.
- 3.5.5 Fabricator's date of corrugating or forming into pipe by a six (6) digit number indicating in order the year, month and day of the month.
- 3.6 The marking shall be applied to the sheet by a permanent method such as coining into the metal. This identification shall appear on the outside of the pipe.
- 3.7 *Sheet Manufacturer's Analysis:*
The manufacturer of each brand shall furnish a certificate setting forth the name or brand of aluminum alloy to be furnished, and a statement that the material conforms to the specified chemical composition limits. The certificate shall be sworn to for the manufacturer by a person having legal authority to bind the company.

3 Fabrication: (continued)**3.8** *Sheet Manufacturer's Guarantee:*

The manufacturer of the sheets shall submit, with the analysis, a guarantee providing that all aluminum alloy furnished shall conform to the applicable requirements of the latest revision of ASTM B209 for Alclad alloy 3004-H34 unless otherwise specified and shall bear a suitable identification brand or mark, and shall be replaced without cost to the purchaser when not in conformity with the specified analysis, sheet thickness, or cladding thickness, and the guarantee shall be so worded as to remain in effect so long as the manufacturer continues to furnish material.

3.9 Fabrication of the corrugated aluminum pipe shall conform to the requirements of AASHTO M 196, the Standard Specifications, and the plans for the specific project, and the Special Provisions.

4 Certification:

4.1 The testing agency shall submit appropriate manufacturer's mill test reports and chemical analysis representing each lot number used. The certification shall be submitted with the samples, and under separate cover. The reports shall include the following:

4.1.1 Lot number.

4.1.2 Gauge.

4.1.3 Corrugation size.

4.1.4 Diameter and quantity of pipe.

4.1.5 Type of seam.

4.1.6 Name of supplier.

4.1.7 Montana highway project for which the material is designated.

5 Approval for Shipments of Culverts

5.1 Culverts and/or related material shall not be approved for shipment until they have been found to comply with our specifications.

5.2 Evidence of approval shall be by means of the inspecting agency's ID stamp or tag placed on a noticeable location on each section of the inspected material.

5.3 In the event of any questions pertaining to the approval for shipment of culverts and/or related material, contact the Materials Bureau.

6 Field Inspection and Acceptance

6.1 The field inspection shall be made by the Project Manager who shall be furnished by the seller with an itemized statement of the sizes and lengths of culvert pipe in each shipment. This inspection shall include an examination of the culvert pipe for deficiency in length of finished pipe, and any evidence of damage during shipment. Along with the proper approval stamp or tag from the inspecting agency.

METHODS OF SAMPLING AND TESTING
MT 402-04
METHOD OF SAMPLING AND TESTING CORRUGATED STEEL PIPE
(AASHTO M 36)

1 Scope:

- 1.1 The specification covers corrugated steel pipe intended for use for storm water drainage, under-drains, the construction of culverts, and similar uses. The steel sheet used in fabrication of the pipe has a protective metallic coating of zinc (galvanizing), aluminum, or aluminum-zinc alloy.

2 Referenced Documents:

2.1 AASHTO:

M 36 Corrugated Steel Pipe, Metallic-Coated, for Sewers and Drains

3 Sampling Procedure:

- 3.1 Sampling shall be performed or witnessed by MDT or an approved inspecting agency at the point of manufacture.
- 3.2 Random sampling shall consist of at least one set of three 3" x 3" samples per gauge, heat number, lot number and type of corrugation. Samples shall be obtained a minimum of 3" from any edge.
- 3.3 Previously tested material that is properly marked and accepted need not be re-sampled, but must be listed in the test report.
- 3.4 In the event that the samples fail to comply, two additional sets of three samples will be taken from the same gauge, heat number, lot number and type of corrugation. Both additional sets must comply with the requirements or the entire lot number will be rejected.

4 Fabrication:

- 4.1 Fabrication of the corrugated steel pipe shall conform to the requirements of AASHTO M 36, the Special Provisions, the Standard Specifications, and the plans for the specific project.

5 Certification:

- 5.1 The inspecting agency shall verify that all materials are in compliance with the "Buy America" provision in the Montana Standard Specifications for Road and Bridge Construction. Upon receipt of the materials, the Contractor will submit the appropriate test reports and chemical analysis representing each lot number on the Contractors Certificate of Compliance, Form 406. The reports shall include the following:
- 5.1.1 Lot number
- 5.1.2 Heat number.
- 5.1.3 Gauge.
- 5.1.4 Corrugation size.
- 5.1.5 Diameter and quantity of pipe.

5 Certification: (continued)

- 5.1.6 Type of seam.
- 5.1.7 Weight of coating in oz/ft² or g/m².
- 5.1.8 Name of supplier.
- 5.1.9 Montana Department of Transportation project for which the material is designated.
- 5.1.10 Two copies of the report are to be forwarded to the District Laboratory.

6 Approval for Shipment of Culverts:

- 6.1 Culverts and/or related material shall not be approved for shipment until they have been found to comply with our specifications.
- 6.2 Evidence of approval shall be by means of the inspecting agencies ID stamp or tag placed on a noticeable location on each section of the inspected material.
- 6.3 In the event of any questions pertaining to the approval for the shipment of culverts and/or related material, contact the Materials Bureau.

7 Field Inspection and Acceptance:

- 7.1 Field inspection shall be made by the Engineering Project Manager who shall be furnished by the seller with an itemized statement of the sizes and lengths of culvert pipe in each shipment. This inspection shall include an examination of the culvert pipe for deficiency in length and any evidence of damage during shipment along with the proper approval stamp or tag from the inspecting agency and be submitted on a Form 46.

METHODS OF SAMPLING AND TESTING
MT 403-04
SAMPLING AND INSPECTION OF SEEDING AND LANDSCAPING MATERIALS

1 Scope

- 1.1 Sampling, sample preparation and submittal, supervision of seed blending.

2 Referenced Documents

MT Materials Manual

MT 412 Topsoil Sampling, Sample Preparation and Testing

3 Sampling Procedure

- 3.1 All proposed seed, other than Montana certified "blue tag" seed, will be sampled under MDT supervision. Resampling will not be required if the proposed seed has been pretested at the grain and seed laboratory at Montana State University within a period of twelve (12) months. A miscellaneous sample sheet listing the supplier's name and all the information given on the purity and germination tag must be submitted to the Materials Bureau. List the name and approximate number of each kind or specie of restricted noxious weed seeds occurring per pound on the purity and germination tag. Acceptance of seed is based on compliance with the Standard Specifications for Road and Bridge Construction.
- 3.2 When sampling seeds in bags, a trier long enough to reach all areas in the bag will be used. The trier must be designed so that it will remove an equal volume of seed from each part of the bag through which the trier travels. Unless the trier has partitions in the seed chamber, it must be inserted into the bags horizontally. Sample non-free-flowing seeds difficult to sample with a trier by thrusting the hand into the seed and removing representative portions. When a sample is taken with the hand, insert the hand flat and with the fingers together. Keep the fingers together as the hand is closed and withdrawn. Because of possible segregation, hand samples should be taken from various locations in the bags.
- 3.2.1 Seed in bags.
- 3.2.1.1 For lots of one to six bags, sample each bag.
- 3.2.1.2 For lots of more than six bags, sample five bags plus at least 10% of the number of bags in the lot. Round numbers with decimals to the nearest whole number. Regardless of the lot size, it is not necessary to sample more than 30 bags.
- 3.2.1.3 Closed and open bags should be sampled with a long trier, probe, or bag sampler extending the full length of the bag. In sampling open bags it must be recognized that the sample may not represent the original shipment.
- 3.2.1.4 A trier or probe is available from the Materials Bureau on request and must be returned immediately upon completion of sampling.
- 3.2.1.5 Seed which has been pretested under Materials Bureau supervision need not be resampled by project personnel. If there is a reason to believe that the material received on the project has not been pre-tested, the sampling procedure described above shall be adhered to.
- 3.3 Submit a one quart (one liter) container for each lot of seed sampled. Should the total quantity of seed sampled be in excess of one quart (one liter), reduce the sample by means of quartering or splitting.

- 3.4 Submit the seed sample along with the purity and germination tag directly to the Seed Lab at Montana State University. Submit a miscellaneous sample sheet with the following information to the Materials Bureau: all pertinent project information, supplier's name and address, kind of seed, all of the information given on the purity and germination tag and the amount of seed the sample represents.
- 3.5 Blending supervision – Seed blending performed in the field will be supervised on the job site by project personnel. Arrangements will be made for the supervision of blending when performed by a dealer or supplier. A blending report will be submitted to the Materials Bureau.
- 3.6 On each seeding project, retain a one quart container of each blend until such time as the project has been completed and accepted. The same will apply to seed not incorporated in a blend, but applied directly. This will constitute a referee sample should a question arise relative to the purity and germination of the original sample.

4 Fertilizer

- 4.1 Sampling will be performed by field personnel at the project site. In the case of blended fertilizer, a sample of the blended material will be sampled for analysis. Obtain sufficient material to fill a one quart (one liter) container from the top, center, and bottom of each fertilizer container to be sampled. Only one sample will be required from each lot, except that sampling is not required for projects under 500 pounds.
- 4.2 Each sample submitted to the Materials Bureau will be accompanied by the certified chemical analysis tag, a miscellaneous field sheet listing the supplier's name, the kind of fertilizer, the lot number, all of the information given on the certified chemical analysis tag, and the total pounds the sample represents.

5 Mulch

- 5.1 Vegetative mulch – The project inspection of mulch for conformance with the Standard Specifications will be arranged by field personnel. In connection with this inspection, the Materials Bureau will be furnished with a report which will include the following information: Source, type, condition, purity, and moisture content of the mulch.
- 5.2 Wood cellulose fiber mulch – The project inspection of mulch for conformance with the Standard Specifications will be arranged by field personnel. In connection with this inspection, the Materials Bureau will be furnished with a report, which will include the following information: Source, type, and moisture content of the mulch.
- 5.3 Peat moss – A one pound representative sample will be submitted to the Materials Bureau for pH analysis.
- 5.4 Bark chip mulch – Bark chips derived from the bark of Douglas Fir, Pine, or Hemlock will be acceptable. All material must be reasonably free from weed seeds and other foreign material such as grasses, chaff, and substances toxic to plant growth. Individual bark chips will have a maximum dimension of 3 inches and not more than 10% of the chips can pass through a 3/4 inch sieve. A 25-pound sample will be submitted to the Materials Bureau for testing.
- 5.5 Manure – The term "Manure" will apply to stockpiled, well-rotted cattle, sheep, or horse manure or combinations of such, more than one year old, reasonably free of debris and foreign matter. Before being used in any planting operation, the manure must be shredded to break up large chunks and to assure proper mixing with other materials. Before any manure is hauled to the project site it must be approved by the landscape architect or engineer.
- 5.6 Fabricated netting – The project inspection of netting for conformance with the Standard Specifications will be arranged by field personnel. In connection with this inspection, the Materials Bureau shall be furnished with a report which shall include the source, type, and condition of the material.

6 Emulsified Binder

6.1 When the quantity of emulsified binder is in excess of 10,000 gallons, a one-quart representative sample of the emulsified asphalt proposed for use on the project shall be submitted to the Materials Bureau. Ship emulsified binder in plastic containers.

7 Topsoil

7.1 With the exception of topsoil which has been stripped and is stockpiled for later replacement, a two pound sample of each kind or type will be sampled and tested in accordance with MT-412.

8 Sod

8.1 The material will be inspected on-site, a miscellaneous field sample sheet (Form 46) will list source, grass specie, and thickness of sod, and also the total quantity of material represented by the sample, and forwarded to the Materials Bureau.

9 Nursery Stock

9.1 The project inspection of nursery stock will be performed by the Manager, Field Project Unit for conformance with the specifications contained in the project proposal. In connection with this inspection, the Materials Bureau is to be furnished with a report which will include the following information: supplier, stock name, quantity, condition, minimum and maximum size or spread of trees and shrubs, whether of nursery or collected stock, whether stock is bare-root, balled and burlapped or plotted and number of trees and shrubs accepted.

9.2 The following is an example of a nursery stock inspection report:

COMMON NAME	BOTANICAL NAME	QUANTITY	SIZE
Ponderosa Pine	Pinus ponderosa	6	1'6" - 1'0"

All of the specified size, all potted nursery stock, all in good condition and all accepted.

Common Lilac	Syringa Vulgaris	140	25" - 35"
--------------	------------------	-----	-----------

All of the specified size, all nursery stock, all in good condition and all accepted.

METHODS OF SAMPLING AND TESTING
MT 404-04
METHOD FOR INSPECTING WOOD PRODUCTS
(Montana Method)

1 Scope:

- 1.1 This method includes the inspection of all wood products at the mills, the treating plant and after shipment to the job-site.
- 1.2 A detailed procedure for inspecting wood products is not included in this method because the primary responsibility for such inspections is charged to the Inspector at the Materials Bureau. In the event division or other personnel are required to make inspections of wood products, attention is directed to paragraph 5.1, below.

2 Mill Inspection:

- 2.1 Plant inspection of all wood products will consist of checking grade, dimensions, etc., in accordance with the applicable section in the Standard Specifications.

3 Treating Plant Inspection:

- 3.1 (Wood products to be treated may be inspected in the white to determine its suitability for treatment.) After treating is completed, the wood products must be inspected again for:
- 3.1.1 Adequacy of the treatment.
- 3.1.2 Damage which may have been caused by or during the treating cycle, or in subsequent handling.
- 3.2 It is essential that the treating plants call the Materials Bureau at least 48 hours in advance of the time requested for an inspection.

4 Final Inspection:

- 4.1 At the time of final inspection, all acceptable large timbers (guardrail posts, pilings, sign posts, etc.) are individually stamped with the Circle (M) stamping hammer which denotes acceptance prior to shipment.
- 4.2 The acceptance of small items (fence posts, etc.) prior to shipment is indicated by inspection seals attached to each bundle.

5 Job-Site Inspection:

- 5.1 In the event that the inspector from the Materials Bureau is unable to perform the inspection at the plant, Division personnel may be called upon to perform the inspection in the field. Division personnel are directed to contact the Materials Bureau for specific instructions.
- 5.2 All wood products are subject to final field approval after delivery to the project.

METHODS OF SAMPLING AND TESTING
MT 405-04
WIRE CLOTH SIEVES FOR TESTING PURPOSES
(Modified AASHTO M 92)

1 Scope:

- 1.1** This specification covers the requirements for the design and construction of sieves using a medium of woven-wire cloth mounted in a frame for use in testing for the classification of materials according to designated nominal particle size and wire cloth, meeting the specifications of Table 1, to be designated test grade wire cloth. All subsequent references to wire cloth shall mean test grade wire cloth.

2 Referenced Documents:

- 2.1** *AASHTO:*
M 92 Wire Cloth and Sieves for Testing Purposes

3 Sieve Cloth Requirements:

- 3.1** Wire cloth used in U.S.A. standard testing sieves meeting the specifications shown in Table 1 shall be designated "test grade". Test grade cloth shall be woven from stainless steel, brass, bronze, or other suitable wire with a plain weave, except that cloth with openings of 63 μm (No. 230) and finer may be woven with a twill weave. The wire shall not be coated or plated.
- 3.2** The openings of the sieve cloth of successive sieves from a base of 1 mm in the ration of approximately $4\sqrt{2} : 1$.
- 3.3** All measurements of openings and wire diameters shall be made along the midpoints of the opening.
- 3.4** Sieve cloth shall conform to the dimensional requirements of Table 1. The average opening (distance between parallel wires measured at the center of the opening), in the horizontal and vertical directions measured separately, shall conform to the values in Column 1, within the permissible variation in average opening size shown in column 4. Not more than 5% of the openings shall exceed the value shown in Column 5. The maximum individual opening size shall not exceed the value shown in Column 6.
- 3.4.1** The average diameter of the horizontal and vertical wires, measured separately, shall conform to the diameter in Column 7 within the tolerances in Footnote A of Table 1.
- 3.5** Wires shall be crimped in such a manner that they will be rigid when in use.
- 3.6** There shall be no punctures or obvious defects in the wire cloth.

4 Test Sieve Frames:

- 4.1** *General Requirements* - Frames for wire cloth sieves shall be constructed in such a manner as to be rigid. The wire cloth shall be mounted on the frame without distortion, looseness or waviness. To prevent the material being sieved from catching in the joint between the wire cloth and the frame, the joint shall be filled smoothly or constructed so the material will not be trapped.
- 4.2** *Standard Frames*--The standard sieve frame shall be circular with nominal diameters of 3, 6, 8, 10 or 12 inches (76, 127, 203, 254, or 305 mm) as may be specified. The dimensions shall conform to the requirements of Table 2. Frames shall be made from noncorrosive material such as brass or stainless steel and be of seamless construction.

4 Test Sieve Frames: (continued)

- 4.2.1 The bottom of the frame shall be constructed so as to provide an easy sliding fit with any sieve frame of the same nominal diameter conforming to the specified dimensions.
- 4.2.2 The joint or fillet at the connection of the sieve cloth to the frame will provide a minimum clear sieving surface with a diameter equal to the nominal diameter less 0.5 in. (13 mm).
- 4.3 *Nonstandard Frames* – Other sieve frames may be square, rectangular, or circular. The frame may have the sieve cloth permanently installed, or be designed to permit replacement. The provisions of 5.1 apply.

Note 1 – While there are no requirements for nesting of nonstandard frames, care should be applied in the use to prevent loss of material during analysis.

- 4.4 *Pans and Covers* – Pans and covers for use with sieves shall be made so as to nest with the sieves. Pans with extended rims (“stacking skirts”) shall be furnished when specified. The pans and covers shall conform to the dimensions of Table 2.

5 Product Marking:

- 4.1 Each sieve shall bear a label marked with the following information:
 - 4.1.1 U.S.A. Standard Testing Sieve,
 - 4.1.2 ASTM designation E 11,
 - 4.1.3 Standard sieve designation (from Table 1, Column 1),
 - 4.1.4 Name of manufacturer or distributor, and
 - 4.1.5 Alternative sieve designation (from Table 1, Column 2) Optional.
- 4.1.6 Each test sieve shall bear a unique serial number permanently engraved or etched onto the sieve frame, skirt or nameplate.

TABLE 1 Nominal Dimensions, Permissible Variations for Wire Cloth of Standard Test Sieves (U.S.A. Standard Series)

Sieve Designation		Nominal Sieve Opening, in. ^c	Permissible Variation of Average Opening from the Standard Sieve Designation mm	Maximum Opening Size for Not More than 5% of Openings mm	Maximum Individual Opening mm	Nominal Wire Diameter, mm ^a
Standard ^b mm	Alternative					
(1)	(2)	(3)	(4)	(5)	(6)	(7)
125	5 in.	5	±3.7	130.0	130.9	8.0
106	4.24 in.	4.24	±3.2	110.2	111.1	6.40
100 ^d	4 in. ^d	4	±3.0	104.0	104.8	6.30
90	3½ in.	3.5	±2.7	93.6	94.4	6.08
75	3 in.	3	±2.2	78.1	78.7	5.80
63	2½ in.	2.5	±1.9	65.6	66.2	5.50
53	2.12 in.	2.12	±1.6	55.2	55.7	5.15
50 ^d	2 in. ^d	2	±1.5	52.1	52.6	5.05
45	1¾ in.	1.75	±1.4	46.9	47.4	4.85
37.5	1½ in.	1.5	±1.1	39.1	39.5	4.59
31.5	1¼ in.	1.25	±1.0	32.9	33.2	4.23
26.5	1.06 in.	1.06	±0.8	27.7	28.0	3.90
25.0 ^d	1 in. ^d	1	±0.8	26.1	26.4	3.80
22.4	7/8 in.	0.875	±0.7	23.4	23.7	3.50
19.0	3/4 in.	0.750	±0.6	19.9	20.1	3.30
16.0	5/8 in.	0.625	±0.5	16.7	17.0	3.00
13.2	0.530 in.	0.530	±0.41	13.83	14.05	2.75
12.5	1/2 in. ^d	0.500	±0.39	13.10	13.31	2.67
11.2	7/16 in.	0.438	±0.35	11.75	11.94	2.45
9.5	3/8 in.	0.375	±0.30	9.97	10.16	2.27
8.0	5/16 in.	0.312	±0.25	8.41	8.58	2.07
6.7	0.265 in.	0.265	±0.21	7.05	7.20	1.87
6.3 ^d	1/4 in. ^a	0.250	±0.20	6.64	6.78	1.82
5.6	No. 3½	0.223	±0.18	5.90	6.04	1.68
4.75	No. 4	0.187	±0.15	5.02	5.14	1.54
4.00	No. 5	0.157	±0.13	4.23	4.35	1.37
3.35	No. 6	0.132	±0.11	3.55	3.66	1.23
2.80	No. 7	0.111	±0.095	2.975	3.070	1.10
2.36	No. 8	0.0937	±0.080	2.515	2.600	1.00
2.00	No. 10	0.0787	±0.070	2.135	2.215	0.900
1.70	No. 12 ^c	0.0661	±0.060	1.820	1.890	0.810
1.40	No. 14	0.0555	±0.050	1.505	1.565	0.725
1.18	No. 16	0.0469	±0.045	1.270	1.330	0.650
1.00	No. 18	0.0394	±0.040	1.080	1.135	0.580
0.850	No. 20	0.0331	±0.035	0.925	0.970	0.510
0.710	No. 25	0.0278	±0.030	0.775	0.815	0.450
0.600	No. 30	0.0234	±0.025	0.660	0.695	0.390
0.500	No. 35	0.0197	±0.020	0.550	0.585	0.340
0.425	No. 40	0.0165	±0.019	0.471	0.502	0.290
0.355	No. 45	0.0139	±0.016	0.396	0.425	0.247
0.300	No. 50	0.0117	±0.014	0.337	0.363	0.215
0.250	No. 60	0.0098	±0.012	0.283	0.306	0.180
0.212	No. 70	0.0083	±0.010	0.242	0.263	0.152
0.180	No. 80	0.0070	±0.009	0.207	0.227	0.131
0.150	No. 100	0.0059	±0.008	0.174	0.192	0.110

TABLE 1 Nominal Dimensions, Permissible Variations for Wire Cloth of Standard Test Sieves (U.S.A. Standard Series)

Sieve Designation		Nominal Sieve Opening, in. ^c	Permissible Variation of Average Opening from the Standard Sieve Designation mm	Maximum Opening Size for Not More than 5% of Openings mm	Maximum Individual Opening mm	Nominal Wire Diameter, mm ^a
Standard ^b mm	Alternative					
(1)	(2)	(3)	(4)	(5)	(6)	(7)
0.125	No. 120	0.0049	±0.007	0.147	0.163	0.091
0.106	No. 140	0.0041	±0.006	0.126	0.141	0.076
0.0090	No. 170	0.0035	±0.005	0.108	0.122	0.064
0.075	No. 200	0.0029	±0.005	0.091	0.103	0.053
0.063	No. 230	0.0025	±0.004	0.077	0.089	0.044
0.053	No. 270	0.0021	±0.004	0.066	0.076	0.037
0.045	No. 325	0.0017	±0.003	0.057	0.066	0.030
0.038	No. 400	0.0015	±0.003	0.048	0.057	0.025
0.032 ^d	No. 450 ^d	0.0012	±0.003	0.042	0.050	0.028
0.025 ^d	No. 500 ^d	0.0010	±0.003	0.034	0.041	0.025
0.020 ^d	No. 635 ^d	0.0008	±0.003	0.029	0.035	0.020

TABLE 2 Dimensions of Standard Frames

Nominal Diameter	Mean Diameter, in. (mm)		Typical Frame ^A
	Inside at Top ^B	Outside of Skirt	
In.			Nominal Height ^C in. (mm)
3	3.000 + 0.030/-0.000 (76 + 0.76/ -0.00)	3.000 + 0.000/-0.030 (76 + 0.00/ -0.76)	1 1/4 (32) FH ^D 5/8 (16) HH
6	6.000 + 0.030/-0.000 (152 + 0.76/ -0.00)	6.000 + 0.000/-0.030 (152 + 0.00/ -0.76)	1 3/4 (45) FH 1 (25) HH
8	8.000 + 0.030/-0.000 (203 + 0.76/ -0.00)	8.000 + 0.000/-0.030 (203 + 0.76/ -0.76)	2 (50) FH 1 (25) HH
10	10.000 + 0.030/-0.000 (254 + 0.76/ -0.00)	10.000 + 0.000/-0.030 (254 + 0.00/ -0.76)	3 (76) FH 1 1/2 (38) HH
12	12.000 + 0.030/-0.000 (305 + 0.76/ -0.00)	12.000 + 0.000/-0.030 (305 + 0.00/ -0.76)	3 1/4 (83) FH 2 (50) IH 1 5/8 (41) HH

^A Other frame heights are not precluded.

^B Measured 0.2 in. (5 mm) below the top of the frame.

^C Distance from the top of the frame to the sieve cloth surface.

^D FH = full height, HH = half height, IH = intermediate height.

METHODS OF SAMPLING AND TESTING
MT 406-04
METHOD OF SAMPLING AND INSPECTION OF SIGNING MATERIAL AND SIGNS
(Montana Method)

1 Scope

- 1.1 Following the determination of a successful bidder, and upon the letting of a project to contract, a letter is sent to the prime contractor by the Materials Bureau requesting the source of bid items in the contract. These items include signing material and signs. Upon receipt of the information, the Certification Inspection Supervisor in the Materials Bureau will arrange for inspection. The following procedures and requirements shall be observed whenever signs are included in a project.

2 Referenced Documents

- 2.1 Montana Department of Transportation Detailed Drawings

3 Reporting

- 3.1 A copy of all correspondence, test results, certificates and other pertinent documents shall be submitted to the Materials Bureau, attention Certification Inspection Supervisor.

4 Signing Material

- 4.1 Inspection of signing material will be performed by either another state, by a commercial inspection and testing agency, or if the material was not pre-inspected by field personnel.

5 Sign Fabrication Inspection

- 5.1 Sign fabrication inspection involves visual observation of sign materials, fabrication procedures, and the manufactured product to ensure that it will serve the intended purpose for its expected performance life.
- 5.2 Material specifications are outlined in the Standard Specifications for Road and Bridge Construction and in the contract special provisions. Materials used in the fabrication of highways signs are inspected by an inspection agency for each construction contract.
- 5.3 In-Plant sign inspection and approval does not constitute mandatory acceptance by the Project Manager of the delivered product. It is possible that signs may be damaged in transit because of inadequate packaging or poor handling and will be rejected at the project site. Approval of a sign at the point of fabrication means that the inspector has assured himself that all materials used meet the plan specifications and that finished signs are satisfactory in appearance and workmanship.

6 Materials

- 6.1 Inspection & Sampling: Following is a listing of the materials used in the fabrication of signs and the required sampling procedures before the subject material may be approved for use.
- 6.2 6061 T6 or 5052 H38 Aluminum Sheeting can be accepted on certification of conformance and certified mill test reports. No sample is required unless deemed necessary by the Inspector. If samples are required, they shall be sampled as follows: Two samples of size 3/4 inch x 9 inch of each gauge will be taken from each consignment of aluminum received for signing. Samples will be oriented with the longer dimension parallel to the direction of rolling. The Materials Bureau will machine these samples to comply with ASTM E8-80A. A Certificate of Compliance including Certified Mill Test Reports of each gauge is required.
- 6.3 Aluminum Sign Blanks: Each consignment of aluminum sign blanks is spot checked with a micrometer for gauge thickness conformance. Certificates of Compliance and a Certified Mill Test Report of each gauge are required.

- 6.4 6063 T6 Extruded Aluminum T-Sections (Wind Beam): Certificates of Compliance, Certified Mill Test Reports, and Chemical Analysis are required for each order. No sample is required unless deemed necessary by the Inspector.
- 6.5 HD (High Density) Plywood: The minimum allowable plywood grade shall be B-B high density overlay 60/60 with amber overlay on both sides, and a minimum thickness of 3/4" or as shown on plans. A spot check on thickness requirements, grade-trademark for Grade and Type of plywood, and a letter attesting to the standard of the plywood received is required. No sample is required unless deemed necessary by the Inspector.
- 6.6 Reflective Sheeting: A portion of each roll will be visually inspected for imperfections. A Certificate of Compliance including the type, grade, color, and purchase order number is required for each roll used in the signing fabrication.

Note 1 –Reflective sheeting from each manufacturer will be sent to the Materials Bureau for reflectivity testing on an annual basis.

- 6.7 Sign Faces: No sampling is required for reflective or non-reflective sign faces. A visual inspection for conformance and imperfections will be performed on each order of sign faces received. A Certificate of Compliance is required for each shipment. The certificate will include type of material and purchase order number.
- 6.8 Applied or Demountable Copy A Certificate of Compliance is required for each order prior to usage. The reflective sheeting for all sign copies shall be Silver-White No. 2 (Parkway - if a 3M product). Encapsulated lens, wide angle reflective sheeting may be used when specified in the plans.

7 Fabrication: Items to be observed by the Inspector During Sign Fabrication

- 7.1 Approved materials.
- 7.2 Visual check of material color and color match with a 150 watt flood light held at eye level at a distance of 50 feet from material being observed.
- 7.3 Visual check of uniform legend color tone and uniform reflectivity with a 150 watt flood light held at eye level at a distance of 50 feet from legend being observed.
- 7.4 Visual check of splices.
- 7.5 Fabrication
 - 7.5.1 Correct thickness of aluminum or plywood.
 - 7.5.2 Correct material for reflectorized and non-reflectorized signs, (sheeting and copy).
 - 7.5.3 Correct "T" sections (wind beam) and proper spacing of "T" sections, (Standard Drawing No. 619-04 and 619-06).
 - 7.5.4 Correct spacing of rivets with heads painted to match signs, (Standard Drawing No. 619-04).

- 7.5.5 Correct spacing of aluminum clips on "T" sections on plywood, (Standard Drawing No. 619-06).
- 7.5.6 Correct sign size, color, and whether copy and background sheeting are reflectorized or non-reflectorized.
- 7.5.7 Corners of control signs rounded.
- 7.5.8 Corners of guide signs rounded when so noted on plans.
- 7.6 Non-Standard Items:
 - 7.6.1 Conformance to contract special provisions. Conformance to special mounting details shown on the plans.

8 Application of Materials

- 8.1 Use of approved equipment and qualified personnel.
- 8.2 Sheeting properly applied.
- 8.3 Absence of foreign particles under applied sheeting.
- 8.4 Absence of air bubbles under applied sheeting.
- 8.5 Absence of loose edges.

9 Workmanship

- 9.1 Correct sign layout and size.
- 9.2 Sharp clear screened sign messages.
- 9.3 Proper horizontal and vertical spacing.
- 9.4 Correctly spelled words.
- 9.5 Symbols correctly depicted.
- 9.6 Back of sign clean and free of corrosion.
- 9.7 Sign number on back of guide signs.

10 Design Conformance

- 10.1 Completed Signs:
 - 10.1.1 All completed signs will conform to the Manual on Uniform Traffic Control Devices, and Standard Highway Signs as specified in the MUTCD, 1978 with addendums; except as may be provided for in the Montana Standard Drawings, Montana Sign Index, or contract plans and approved shop drawings.
 - 10.1.2 All completed signs that are in conformance will be stamped on the back of the sign, by the inspector, with the inspecting agency's stamp of approval.

- 10.1.3 Test reports for signing material, inspected and sampled by a commercial agency, will be sent to the inspecting agency by the Materials Bureau upon completion of the tests.
- 10.1.4 Test reports for material sampled by field personnel will be issued upon completion of the tests.
- 10.1.5 The supplier for all major signing material must provide the manufacturer's Certificates of Compliance. Copies of all certificates will be kept in the Materials Bureau project files.
- 10.1.6 Acceptance reports for material used on pre-inspected signs that were supplied from out-of-state will be submitted to the field in the final report.
- 10.1.7 The field shall provide the Materials Bureau with inspection and acceptance reports whenever un-inspected signing material that has been supplied from out-of-state is delivered to the project. (Section 10.2.4).
- 10.2 Signs Supplied Locally or from Out-of-State:
 - 10.2.1 Signs that have been supplied locally or out-of-state are inspected at the source as designated by the Materials Bureau. Following inspection, a report listing the number and kind of signs will be submitted to the field and to the Materials Bureau.
 - 10.2.2 In the event that the signs have not been pre-inspected, the Materials Bureau shall require a Field Inspection and Acceptance Report in addition to the manufacturer's Certificates of Compliance (Section 10.1.5).
 - 10.2.3 Signs are inspected for conformance with the Montana Department of Transportation specification requirements. Locally inspected signs will bear evidence of having been inspected by the presence of the inspecting agency's stamp of approval. Unpackaged signs will bear a stamp on the back of the sign, while packaged signs will bear a stamp on the package face.
 - 10.2.4 Locally supplied signs that have not been inspected may be delivered to a project only in the case of extreme urgency for installation. For such cases, the suppliers have been directed to immediately forward a letter to the Materials Bureau and to the Project Manager describing the circumstances under which the signs (not inspected) were shipped. This letter must designate the project and location to which the signs were delivered and list the kind and quantity of signs. Signs that have been shipped without inspection shall not be accepted until the manufacturer has submitted this letter.
 - 10.2.5 It is imperative that the Materials Bureau, attention Certification Inspection Supervisor, be informed of the field inspection and acceptance of all signs that do not show evidence of inspection at the source. The following information will be included in this inspection report:
 - 10.2.5.1 Appearance and workmanship
 - 10.2.5.2 Conformance to specifications
 - 10.2.5.3 Type, size, and quantity
 - 10.2.5.4 Gauge of aluminum
 - 10.2.5.5 Thickness or ply of plywood

- 10.3 Final Signing Material and Sign Acceptance Reports:
- 10.3.1 Signing material and signs which have been inspected by a commercial agency will be accepted upon receipt of all required Certificates of Compliance.
 - 10.3.2 Signing material and signs which have been supplied from out-of-state but which have not been inspected will be accepted upon receipt of required certificates from the supplier, a field inspection, and an acceptance report.
 - 10.3.3 Signing material and signs which have been supplied from out-of-state and have been inspected by a commercial agency will be accepted on the reports issued by the agency.
 - 10.3.4 Signing material and signs which have been supplied locally and have been inspected by the District will be accepted on the reports issued by the District.
 - 10.3.5 All signing material and signs, regardless of source and inspection procedure, are subject to final field approval.

METHODS OF SAMPLING AND TESTING
MT 407-05
METHOD OF TEST FOR HIGH-STRENGTH BOLTS

1 Scope:

1.1 The method covers rotational capacity testing of high strength bolts used in bridge construction.

2 Referenced Documents:

2.1 AASHTO:

M 164 (M 164M), High-Strength Bolts for Structural Joints

M 291 (M 291M), Carbon and Alloy Steel Nuts

M 292 (M 292M), Carbon and Alloy Steel Nuts for Bolts for High-Pressure or High-Temperature Service or Both

Procedure A: (Long Bolts in Tension Calibrator)

3 Apparatus:

3.1 A Skidmore-Wilhelm calibrator for measuring bolt tension, of sufficient capacity for the bolts to be tested.

3.2 Calibrated torque wrench.

3.3 Spacers and/or washers with a maximum hole size $1/16$ in. (2mm) larger than the bolt to be tested.

3.4 A steel section on which to mount the bolt calibrator. The flange of a girder or a cross-frame accessible from the ground is acceptable.

4 Procedure:

4.1 Use black fasteners oily to the touch at testing. Clean all weathered or rusty fasteners of all rust and re-lubricate prior to testing. Lubricate all galvanized fasteners with a visible dye, so a visual check verifies the lubricant's presence.

4.2 Measure the bolt length, not including the head.

4.3 Thread a nut onto the bolt with sufficient spacers or washers to bring the bolt end to at least flush with the tightened nut to a maximum bolt stick-out of three threads. Provide 3 to 5 threads between the inside faces of the nut and the bolt head. Always use a hardened washer under the nut.

4.4 Tighten the nut with a wrench to produce the appropriate snug tension from Table 1, with an allowable error range from 0 kips to +2 kips (0 to + 9 kn). The snug condition should be the normal effort applied with a 12-inch wrench.

Table 1

Bolt Dia. (in.)	1/2	5/8	3/4	7/8	1	1 1/8	1 1/4	1 3/8	1 1/2
Snug Tension (kips)	1	2	3	4	5	6	7	9	10
Bolt Dia. (mm)	20			22			24		
Snug Tension (kN)	13			18			23		

4 Procedure: (continued)

4.5 Match-mark the bolt, nut and face plate of the calibrator.

4.6 Using the torque wrench, tighten the nut to at least the tension in Table 2. Record the bolt tension and the torque that produced the tension. (Measure the torque with the nut in motion). Calculate the following value for maximum allowable torque given by: $T = 0.25 PD$, where P= tension in lbs. (N) and D = diameter of bolt in feet (m).

The fastener assembly fails the test at this point if the recorded torque exceeds the value, T, as calculated above.

Table 2

Bolt Dia. (in.)	1/2	5/8	3/4	7/8	1	1 1/8	1 1/4	1 3/8	1 1/2
Tension (kips)	12	19	28	39	51	56	71	85	103
Bolt Dia. (mm)	20			22			24		
Tension (kN)	125			173			227		

4.7 Tighten the nut further by the number of turns shown in Table 3, using the radial lines on the calibrator faceplate for reference. The rotation is measured from the initial marking in step 4.5. Record the bolt tension. Bolt and nut assemblies which strip or fracture before achieving the full rotation have failed the test.

Table 3

Bolt Length	4 x bolt dia. or less	Greater than 4 but no more than 8 x dia.	Greater than 8 x dia.
Required Rotation	2/3	1	1 1/6

4.8 Compare the bolt tension recorded from Section 4.7 with the appropriate value from Table 4. Fastener assemblies that do not provide the minimum required tension shown in Table 4 at the rotation shown in Table 3 have failed the test.

Table 4

Bolt Dia. (in.)	1/2	5/8	3/4	7/8	1	1 1/8	1 1/4	1 3/8	1 1/2
Tension (kips)	14	22	32	45	59	64	82	98	118
Bolt Dia. (mm)	20			22			24		
Tension (kN)	142			200			262		

4.9 Remove the nut and bolt from the calibrator and examine them. The fastener assembly has failed the test if threads show signs of stripping, shear or torsion failure or the nut fails to turn freely, by hand, on those threads occupied by the nut in the test position. (The nut does not have to freely turn the entire length of the thread to pass this test.)

Procedure B (Bolts too short for tension calibrator)

5 Apparatus:

5.1 Calibrated torque wrench and hand wrenches.

5.2 Spacers and/or washers with a maximum hole size 1/16 in. (2mm) larger than the bolt.

5.3 A steel section with holes sized 1/16 in. (2mm) larger than the bolt diameter, with a plate thickness that will accommodate section 6.3.

6 Procedure:

- 6.1 Use black fasteners oily to the touch at testing. Clean all weathered or rusty fasteners of all rust and re-lubricate prior to testing. Lubricate all galvanized fasteners with a visible dye, so a visual check verifies the lubricant's presence.
- 6.2 Measure the bolt length, not including the head.
- 6.3 Install the fastener assembly in the steel plate with sufficient spacers or washers to bring the bolt end out at least flush with the tightened nut, to a maximum bolt stick-out of three threads. Provide three to five threads in the length of bolt between the inside faces of the nut and bolt head. Always use a hardened washer under the nut.
- 6.4 Snug the bolt by applying no more than 20% of the torque allowed in Table 6 below, using a torque wrench. Measure and record the torque (with the nut in motion) on the bolt.
- 6.5 Match-mark the nut, bolt and plate.
- 6.6 Tighten the nut with the torque wrench by the number of turns from Table 5. Use a hand wrench to ensure that the bolt does not turn. Measure and record the torque with the nut in motion.

Table 5

Bolt Length	4 x bolt dia. or less	Greater than 4 but no more than 8 x bolt dia.
Required Rotation	1/3 turn	1/2 turn

If the measured torque from section 6.6 exceeds the appropriate value from Table 6, the fastener assembly has failed the test. Assemblies that fail prior to completing this rotation, by stripping or fracture, fail the test.

Table 6

Bolt Dia. (in.)	1/2	5/8	3/4	7/8	1	1 1/8	1 1/4	1 3/8	1 1/2
Torque (Ft/lbs)	150	290	500	820	1230	1500	2140	2810	3690

Bolt Dia. (mm)	20	22	24
Tension (N-m)	710	1100	1570

- 6.7 Tighten the nut further by the appropriate number of turns from Table 7, using the reference mark from section 6.5. Assemblies that fail prior to completing this rotation, by stripping or fracture, fail the test.

Table 7

Bolt Length	4 x bolt dia. or less	Greater than 4 but no more than 8 x bolt dia.
Required Rotation	2/3 turn	1 turn

- 6.8 Remove the nut and the bolt from the plate and examine them. The fastener assembly has failed the test if threads show signs of stripping, shear or torsion failure or the nut fails to turn freely by hand, on those threads occupied by the nut in the test position. (The nut does not have to freely turn the entire length of the thread to pass this test.)

7 Report:

- 7.1 Date tested,
- 7.2 Name of tester,

- 7 **Report:** (continued)
- 7.3 Procedure performed (A or B),
- 7.4 Bolt length,
- 7.5 Bolt tension,
- 7.6 Bolt torque at tension.

METHODS OF SAMPLING AND TESTING
MT 408-10
METHOD OF SAMPLING AND FIELD TESTING BRINE DEICING MATERIAL

1 Scope

1.1 This method covers the sampling and testing of brine deicing material in the field.

2 Reference Documents**ASTM**

D891 Standard Test Methods for Specific Gravity, Apparent, of Liquid Industrial Chemicals

E126 Standard Test Method for Inspection, Calibration, and Verification of ASTM Hydrometer

Other Standards

Clear Roads Document - Clear Roads Snow and Ice Control Chemical Products, Specifications, and Test Protocols (<https://clearroads.org/wp-content/uploads/12-10-Final-CR-SPECS-wCategory4.pdf>).

3 Terminology

3.1 Deicer – a device or a chemical substance for preventing or removing ice.

4 Apparatus

4.1 1-gallon jug (NEW, not used) and a label

4.2 Hydrometer compliant with ASTM E126 specifications with an appropriate scale that includes the target range

4.3 Hydrometer Cylinder

4.4 Personal protection equipment (rubber gloves, eye protection, etc)

4.5 Deicer sampling checklist

5 Field Inspection

5.1 Document and maintain records on all deliveries, including those that are rejected.

5.2 Check to ensure that the product is being delivered according to the terms of the contract. Document the following information:

Bill of Lading with the following information:

Name of product

Supplier and manufacturer of product

Delivery Destination

Total number of units being delivered

Total weight of delivery using certified scale tickets or certified flow meter.

Lot number of product

Date of the order,

Date and time of delivery,

Verification of advance delivery notification,

Delivered in allowable times,

Name of Delivery Company and license plate numbers,

Are any price adjustment assessments required,
 Is the product being delivered what was ordered,
 Document all procedures prior to unloading,
 Verify that all papers required of a delivery are present, complete and legible,
 Legible and current MSDS,
 Certified weight slip.

6 Unloading

- 6.1 Visually inspect the discharge valve prior to unloading for the presence of any foreign material.
- 6.2 Visually inspect the delivered product again while unloading. If problems are noted that are a cause for rejection of the load, immediately halt the unloading process. Take photos and record any pertinent information. Conduct the following procedures if the material is to be rejected.
 - 6.2.1 If the product fails the field inspection or testing, reload the product and reject the load.
 - 6.2.2 If reloading can't be accomplished, (mixed with previous product) note the amount of the product pumped into the tank and total product now in the tank.
 - 6.2.3 Circulate the contents of the tank and then take 2- one gallon (4 liter) samples of the contaminated product now in the tank.
 - 6.2.4 Determine and record the specific gravity of the samples.
 - 6.2.5 Take appropriate action as needed to ensure the integrity of the product on hand if possible. Determine if all products on hand will have to be removed.
 - 6.2.6 Forward all sample directly to MDT's Materials laboratory for testing.
 - 6.2.7 Immediately advise the Purchasing Services Bureau of any ordering, delivery, storage, or product quality issues.

7 Sampling

- 7.1 Remove one gallon of sample from the supplier's truck. Visually inspect the sample and reject the delivery if any foreign material is present.
- 7.2 Purge a minimum of one gallon of product to ensure hoses are free of contamination. Take a one gallon sample from the transfer hose in three equal parts, compositely mixed together, to make up the sample that will be submitted to the laboratory for testing. Collect the samples during unloading as the first third, the second third and the last third of the product is being delivered. If the trailer or pup has compartments, take the three equal samples from only one of the compartments to complete the sample.
- 7.3 Determine the specific gravity of the sample, as described in Section 8. Retain the sample in case of dispute. Dispose of samples after notification by the Purchasing Services Bureau.

8 Specific Gravity Determination

- 8.1 Carefully pour a sufficient quantity of deicer into a clean hydrometer cylinder, taking care to avoid the formation of air bubbles.
- 8.2 Slowly lower the hydrometer in the liquid and release it. After the hydrometer stabilizes and floats freely away from the walls of the cylinder, read the specific gravity at the point the meniscus intersects the hydrometer in accordance to ASTM D891.
- 8.3 Record your results on the Deicer Sampling Checklist.

Magnesium Liquid Deicer Sampling Checklist

- 1 Which tank will product be pumped into? _____
 Gallons of de-icer in tank prior to pumping _____
 Gallons after delivery _____

- 2 Before pumping any material, take a 1-gallon pre-sample. Visually inspect the sample for contamination with foreign material. Determine the specific gravity. Allow pumping to start and dispose of pre-sampled material and go to step 3. Re-sample the material if the sample appears to be contaminated or if it fails the specific gravity. If the second sample appears contaminated or fails the specific gravity, politely inform the delivery driver his product does not meet MDT specification and you must reject the load. If product is rejected immediately contact your supervisor. Retain the second sample for the supervisor.

Specific gravity of pre-sample _____

- 3 Choose one compartment from either truck or trailer to take the official sample. Purge a minimum of one gallon of product to ensure hoses are free of contamination. Take a one-gallon sample in three equal parts, compositely mixed together, to make up the sample that will be submitted to the laboratory for testing. Collect the samples during unloading as the first third, the second third and the last third of the product is being delivered. If the trailer or pup has compartments, take the three equal samples from only one of the compartments to complete the sample. Clean the outside of the sample container and attach the label.

- 4 Determine the specific gravity of the sample. This must be done in view of the delivery driver.

- 5 Record the following:

Samplers Name: _____ Date: _____

Time: _____ Location: _____

Specific Gravity _____ Tons of product delivered _____

Truck _____ or trailer _____ # the sample was taken from.

Delivery driver's signature: _____

METHODS OF SAMPLING AND TESTING
MT 409-12
METHOD OF ACCEPTANCE FOR WELDED STUD SHEAR CONNECTORS
(MONTANA METHOD)

THIS PROCEDURE IS IN DEVELOPMENT

METHODS OF SAMPLING AND TESTING
MT 410-04
METHOD OF INSPECTION, SAMPLING, TESTING, AND
ACCEPTANCE OF PAINT
(Montana Method)

1 Scope

- 1.1 This procedure describes the inspection, sampling, testing and acceptance of construction and maintenance traffic line paint, structural steel primers and finish coats delivered to construction and maintenance projects.

2 Reference Documents**ASTM**

- D711 Standard Test Method for No-Pick-up Times for Traffic Paint
D1640 Standard Test Method for Drying, Curing, or Film Formation of Organic Coatings
D969 Standard Test Method for Laboratory Determination of Degree of Bleeding of Traffic Paint
D1210 Standard Test Method for Fineness of Dispersion of Pigment-Vehicle Systems by Hegman-Type Gage
D562 Standard Test Method for Consistency of Paints Measuring Krebs Unit Viscosity Using a Stormer-Type Viscometer
D823 Standard Practices for Producing Films of Uniform Thickness of Paint, Varnish, and Related Products on Test Panels
D522 Standard Test Methods for Mandrel Bend Test of Attached Organic Coatings
D1475 Standard Test Methods for Density of Liquid Coatings, Inks, and Related Products
D4060 Standard Test Method for Abrasion Resistance of Organic Coatings by the Taber Abraser

MT Materials Manual

MT 601 Materials Sampling, Testing, and Acceptance Guide

3 Sampling

- 3.1 Two samples are required for each lot or batch of paint used on a project. Suitable containers for each type of paint are listed below.
- 3.1.1 Sample Waterborne paints using a clean, one-liter (quart), lined, metal can or plastic "Nalgene" bottle. **Do not use unlined metal containers for Waterborne paint samples.**
- 3.1.2 Sample Alkyd paints using a clean, one-liter (quart), unlined, metal "Asphalt" sampling can. **Do not use plastic "Nalgene" containers for Alkyd paint samples.**
- 3.1.3 Sample Epoxy paints using a clean, one-liter (quart), lined or unlined metal can or plastic "Nalgene" container.
- 3.1.4 Sample Aluminum Mastic paints using a clean, one-liter (quart), unlined metal "Asphalt" can. **Do not use plastic "Nalgene" containers for Aluminum Mastic paint samples.**
- 3.2 Construction Projects - Project quantities of 19 liters (5 gallons) or less: No field sample required. Attach the label from the paint container to a Miscellaneous Form 46 and submit to the Materials Bureau.
- 3.3 Construction Projects - Project quantities greater than 19 liters (5 gallons) but less than 95 liters (25 gallons): No field sample is required. Sample if the type or quality is suspect, at the option of the Department. Submit Manufacturer's Certification to the Materials Bureau attached to a Miscellaneous Form 45.
- 3.4 Construction Projects - Project quantities of 95 liters (25 gallons) or more:
- 3.4.1 Duplicate, one-liter (quart) samples will be taken from the thoroughly mixed contents of a striping machine or container representing each lot. Both samples will be forwarded to the Materials

Bureau for testing with a Miscellaneous Form 45. Acceptance will be based on the test report issued by the Materials Bureau. **CONSTRUCTION PAINT WILL NOT BE PRETESTED AT THE POINT OF MANUFACTURE.**

4 Maintenance Traffic Paint

- 4.1 Duplicate one-liter (quart) samples of thoroughly mixed paint per lot or batch will be sampled by the Montana Department of Transportation at the point of manufacture and be forwarded to the Materials Bureau for testing. Acceptance will be based on the test report issued by the Materials Bureau.
- 4.2 For each paint shipment received, a Field Inspection Report - Miscellaneous Material Form No. 46 shall be prepared and mailed to the Materials Bureau. This report shall indicate the type, quantity, and condition of the paint together with source information (Manufacturer and Lot No., etc.). The label may be taken from the container and attached to the inspection report to transmit the source information.

5 Epoxy Pavement Marking Material

- 5.1 Epoxy pigment and catalyst will be sampled separately and submitted in accordance with 3.1.3 and submit to the Materials Bureau for testing. Manufacturer's certification will be attached to a Miscellaneous Form 45 and submitted with the samples.

6 Thermoplastic Pavement Marking Material

- 6.1 Thermoplastic will be sampled at the point of application. Approximately ½ kilo (1 pound) of the solid material will be submitted to the Materials Bureau for testing. The inspector will supply sample containers. Manufacturer's certification will be attached to a Miscellaneous Form 45 and submitted with the samples.

7 Testing

- 7.1 Test methods used for testing paint shall conform to ASTM, Federal Test Methods Standard No. 141, latest revisions, or tests and methods described below:
- 7.1.1 Flexibility - Apply the paint to produce a 0.0762 mm (0.003 inch) dry film on a 0.25 mm (0.10") tin panel. Air dry at twenty-five (25) degrees centigrade plus or minus 2 degrees (25 °C ± 2°C) or 77 degrees Fahrenheit plus or minus 4 degrees (77 °F ± 4 °F) for at least four (4) hours and then bend over 6.4 mm (1/4 inch) diameter mandrel. The film shall not crack when subjected to the above prescribed flexibility test.
- 7.1.2 Adhesion: Prepare the panel as for the flexibility test. Place the panel on a 3.2 mm (1/8 inch) thick rubber pad. Strike a sharp blow with a ball peen hammer to cause an indentation of 1.27 mm to 2.54 mm (0.05 to 0.10 inch). There shall be no cracking, chipping or peeling when subjected to the above-prescribed test.
- 7.1.3 Skinning: In a 250 ml. paint container (1/2 pint), fill 1/2 full with the paint. Examine after 24 hours for skinning. There shall be no skinning.
- 7.1.4 Settling: Fill a 100 ml. centrifuge tube with paint and revolve for 2 hrs. at a speed producing a centrifugal force of 1,112 Newton (250 pounds). A separation of not more than 12.7 mm (1/2 inch) of the pigment is acceptable. The pigment in the bottom of the tube should be soft and easily dispersed with a spatula.
- 7.1.5 Abrasion: ASTM D4060.
- 7.1.5.1 Abrasion: Federal Test Method Std. No. 141, Method 6192. Panels may be coated by dipping, spraying or by means of film applicator. Dry at 25 °C ± 2 °C (77 °F ± 4 °F) for 24 hours, cure at 49 °C (120 °F) for 72 hours, cool to room temperature and subject to Tabor Abrasion Test using CS-10 wheels, 1000 gram load per wheel and at least 500 revolutions. The dry film thickness should not be less than 0.003 inches prior to testing. The Department performs this test starting

with a wet paint thickness of $0.254 \text{ mm} \pm 0.051 \text{ mm}$ ($0.010 \pm 0.002 \text{ inch}$).

- 7.1.6 Hiding: Use a Standard Horest Hiding Power Chart. Apply at a rate of 16.26 square meters (175 square feet) per 3.785 liters (one gallon). Visual examination will determine acceptance.
- 7.1.7 Film Appearance: Visual examination of dry film on tin panel is performed. The paint shall dry to a flat finish.
- 7.1.8 Light Resistance: Apply a wet film of 0.381 mm (0.012 inches) to two clean 76.2 mm x 127 mm (3x5 inches) tin panels and allow to dry horizontally for twenty-four (24) hours. Expose one (1) of the panels to direct sunlight or to a carbon arc light (no water spray) for a period equivalent to seven (7) hours of direct sunlight. The other panel shall not be exposed. Finally examine both panels and compare for darkening. The yellow paint shall not darken appreciably when subjected to the above-prescribed test.

METHODS OF SAMPLING AND TESTING
MT 412-18
TOPSOIL SAMPLING, SAMPLE PREPARATION, AND TESTING

1 Scope

- 1.1 This procedure of sampling and testing topsoil applies to: 1) topsoil imported from another source (other than the project), and; 2) topsoil intended for use in planting lawns, shrubs, trees or other particular plants (landscaping soil).
- 1.2 Topsoil that has been stripped and is stockpiled on the project site for later placement on median areas, outer separation areas, and side slopes of roadway areas (i.e., salvaging and placing) does not need to be tested.

2 Referenced Documents

AASHTO

- R 90 Sampling Aggregate Products
- T 88 Particle Size Analysis of Soils
- T 267 Determination of Organic Content in Soils by Loss on Ignition

MT Materials Manual

- MT 232 Soil Corrosion Test

3 Sampling Procedures

- 3.1 Samples shall be obtained from each type of soil (homogeneous area). Soil types may be identified from visual appearance or presence of vegetative growth.
 - 3.1.1 Samples of sub-soils may also be taken from borings in conjunction with a subsurface investigation.
 - 3.1.2 Samples from stockpiles or from loaded transports may be taken in accordance with procedures outlined in AASHTO R 90.
- 3.2 Samples from the layer of soil proposed for use as topsoil shall be labeled "topsoil". Samples from the layer of soil over which the topsoil is to be placed shall be labeled "subsoil."
- 3.3 A sample shall be a composite of material from three sampling sites. The sampling sites shall represent similar soils. The sample shall be taken in the following manner.
 - 3.3.1 Dig a v-shaped hole through the thickness of the layer of soil being sampled (if a surface sample) and remove a ½ inch thick slice of soil from one side of it.
 - 3.3.2 Trim off from each side of the slice all but a thin ribbon of soil down the center of the spade face and place in a clean bucket.
 - 3.3.3 Repeat Sections 3.3.1 and 3.3.2 two more times.
 - 3.3.4 Mix thoroughly and keep two pounds (2 lbs) for testing.
- 3.4 Identify the samples by number and the location from which they were taken. Observations concerning the apparent ability of the soil to support plant growth such as the presence or absence of usual or unusual vegetative types, swamps, rock, salt encrustations, etc., should be noted and recorded with the identification data.

4 Sample Preparation

- 4.1 Air dry the samples. Remove larger stones by hand and sieve the remainder of the samples through a 10 mesh (2 mm) sieve.
- 4.2 Weigh the material retained on the 10 mesh sieve. Determine the percent by weight and record on the form accompanying the sample(s). This material is considered gravel.
- 4.3 Submit the minus 10 mesh fraction to the Helena Materials Lab for soils testing.

5 Testing Procedures

- 5.1 Conductivity – Test topsoil in accordance with [MT 232](#).
- 5.2 Soil pH – Test topsoil in accordance with [MT 232](#).
- 5.3 Organic Matter – Test topsoil in accordance with AASHTO T 267.
- 5.4 Gradation – Test topsoil in accordance with AASHTO T 88.

METHODS OF SAMPLING AND TESTING
MT 413-05
INSPECTION AND TESTING OF FENCING MATERIAL

1 Scope:

1.1 This method is intended to cover the inspection, sampling, and testing of fencing materials.

2 Referenced Documents:

2.1 AASHTO:

M 181 Chain Link Fence
M 279 Metallic-Coated Steel Woven Wire Fence Fabric
M 280 Metallic-Coated (Carbon) Steel Barbed Wire
M 281 Steel Fence Posts and Assemblies, Hot-Wrought

Materials Manual:

MT 404 Method for Inspecting Wood Products

3 General Information:

3.1 Material may be inspected and stored. Acceptable material must be identified by tagging or marking until used.

3.2 Visual inspection of mesh, posts and other parts shall be made for workmanship, dimension, condition of galvanizing and freedom from defects in accordance with specifications. Galvanizing shall be checked for excessive roughness, blisters, sal ammoniac spots, bruises, and flaking. Care and judgment must be exercised in making this inspection. Weave and finish (knuckling or barbed) of mesh shall be checked for compliance with specifications.

3.3 If gates are included in the order the design, general workmanship, dimensions, and condition of galvanizing shall be checked for conformance with specifications and applicable drawings. Welded connections shall be inspected to see that they have been cleaned and re-galvanized or painted with approved paint. Whenever practical, materials used and galvanizing procedure shall be checked for compliance with specifications. Observing the fabrication when feasible will be helpful in this regard.

3.4 Samples shall be submitted to the Materials Bureau accompanied by completed Lab. Form No. 45.

3.5 Upon completion of a project, the Project Manager shall submit a report to the Materials Bureau showing the quantity of each type of material inspected and sampled.

3.6 As a guide to the inspector, all applicable specifications for fencing materials can be found in Montana Standard Specification for Road and Bridge Construction, Section 712.

4 Chain Link Fence:

4.1 Inspect and sample chain link fence according to AASHTO M 181.

5 Woven Wire:

5.1 Inspect and sample woven wire according to AASHTO M 279.

6 Barbed Wire:

- 6.1** Inspect and sample barbed wire according to AASHTO M 280. The following is provided as a general guide for field personnel:
- 6.1.1** *Field inspection for General Workmanship:* For the purpose of inspection, a maximum of two spools from the lot shall be inspected for barb length, spacing, overall length, and workmanship. Inspection for barb spacing is normally performed on the outer 25 feet (7.6 m) length of a spool.
- Note 1 – Field personnel may measure barb spacing and inspect for general workmanship. When the barb spacing is measured in the field, the results must be forwarded to the Materials Bureau along with samples for physical testing.*
- 6.1.2** *Re-Inspection:* If either of the sample spools fails to meet the requirements for barb length, spacing, overall length, and workmanship, two additional spools shall be selected at random for inspection. If either of these spools fails to meet the requirements, the lot will be rejected.
- 6.1.3** *Sampling:* For test purposes, select one spool at random from every 50 spools or fraction thereof in a lot, or a total of seven samples, whichever is less. A lot shall consist of all the spools of a single construction (Design Number) of barbed wire delivered at the same time.
- 6.1.4** *Test Specimens for Physical Testing:* Cut a 4-foot (1.2 m) length of barbed wire from the end of each spool and submit to the Materials Bureau for testing. The specimen(s) will be tested for mass of coating and breaking strength.
- 6.1.5** *Lot Size for Retests:* If one or more of the individual wire specimens fails, retest the lot. For retest purposes, four additional spools of barbed wire for each 50 spools shall be sampled. The lot size then becomes 50 spools.

7 Hardware for Barbed or Woven Wire:

- 7.1** *Inspection - Stay wires, brace wires, tie wires, and wire clamps shall be inspected for gauge, condition of galvanizing and compliance with specifications. Any tendency of coating to flake off when wire is manipulated should be observed and noted.*

8 Steel Fence Posts and Assemblies:

- 8.1** Inspect and sample steel fence posts and assemblies according to AASHTO M 281.

9 Wood Fence Posts:

- 9.1** Inspect and sample wood fence posts according to MT 404.

METHODS OF SAMPLING AND TESTING
MT 414-09
METHOD OF ACCEPTANCE FOR REINFORCING STEEL

1 Scope:

- 1.1 The procedure set forth in this method will be followed for the acceptance of all reinforcing steel. The acceptance will be based on certain documents and random sampling.

2 Referenced Documents:**2.1 AASHTO:**

M 31 Deformed and Plain Carbon-Steel Bars for Concrete Reinforcement

ASTM:

A 615 Specification for Deformed and Plain Carbon-Steel Bars for Concrete Reinforcement

3 Required Documents:

- 3.1 For each shipment of reinforcing steel delivered to the project, the contractor shall furnish two copies each of the following documents to the Project Manager:

- 3.1.1 Shipping invoice that shows the weight of all the steel in the shipment.

Note 1 - In the event the steel does not meet the specification requirements, a copy of the manufacturer's invoiced price per pound for this material must be provided.

- 3.1.2 A signed and dated contractors Certificate of Compliance (Form 406).

- 3.2 A shipment shall consist of the entire amount of reinforcing steel in each truckload delivered to the project. When a shipment is made by railroad, each 20 tons or fraction thereof will be considered a shipment.

- 3.3 The Project Manager will retain one set of the documents shown above for his files. The other set will be forwarded to the Materials Bureau after the Project Manager has indicated on the invoice the method by which the steel was accepted. One of the following statements, together with the Project Manager's signature, will be shown on the invoice sent to Helena:

- 3.3.1 *"Shipment accepted on Form 46 and Form 406, no sample taken."*

- 3.3.2 *"Shipment accepted on Form 46 and Form 406 and acceptable test results."*

4 Random Sample Requirement:

- 4.1 In addition to the required documents, a minimum random sampling procedure will be adopted.

- 4.2 As shipments of steel arrive on the project, it will be the responsibility of the Project Manager to decide how many samples, if any, he will take and when and where they will be taken. Sampling will be done by the contractor as directed by the Project Manager in accordance with MT-601, using table 1 as a guide to indicate the minimum number of samples to be taken.

- 4.3 The following are locations in the structure where reinforcing steel samples may be taken, or the remaining portion of the sampled bar may be placed, without adverse effect on the structure. The Bridge Bureau must be contacted if clarification is required on the location of any sample bar.

4 Random Sample Requirement: (continued)

- 4.3.1** *Footing* - The outermost bar in the mat may be sampled. The portion of the bar remaining shall be centered in the footing and used as is.
- 4.3.2** *Column* - The bar nearest the centerline of bent at centerline of structure may be sampled. The sample shall be taken from the top end. The remaining portion of the bar may be used as is.
- 4.3.3** *Slab - Transverse Steel* - Take sample from bar in bottom layer. Center remaining portion of bar between curbs.
- 4.3.4** *Slab - Longitudinal Steel* - Take sample from any line of bars in bottom of slab adjacent to edge of a beam at the end of slab.
- 4.3.5** *Curb* - No sample need be taken.
- 4.3.6** *Bent Cross Beam* - The center bar in bottom layer at bottom of beam may be sampled. Center remaining portion of bar between columns.
- 4.3.7** *T Type Pier Cap* - The center bar in bottom layer at top of cap may be sampled. Center remaining portion of bar over column.
- 4.3.8** If re-sampling under paragraph 6.1.1.1 becomes necessary because of a failure, it will be necessary for the contractor to replace the sampled portion plus the required lap length.
- 4.4** Samples taken will be forwarded immediately to the Materials Bureau for testing in accordance with ASTM A 615 or AASHTO M 31.
- 4.5** The shipment under test shall be kept separate from the other steel on the project until test results have been received.
- 4.6** Steel taken for the purpose of sampling may have to be replaced in the structure. When replacement is necessary it shall be done by the contractor at no cost to the State.

5 Domestic Materials:

- 5.1** No steel will be accepted if it does not comply with Montana Standard Specification for Road and Bridge Construction, Section 106.09.

6 Failing Steel:

- 6.1** In case there is a failure in any size tested under this random sampling procedure, the steel may be rejected in accordance with 6.1.1 or, a price reduction will be assessed in accordance with 6.1.2.
- 6.2** The failing steel may be ordered removed and replaced at no cost to the State if either of the two check samples fail as described in paragraph 6.1.1.1, below.
- 6.3** In the event that a sample of reinforcing steel fails, two additional samples representing the sample that failed may be submitted. Both of the check samples must meet specifications before the shipment will be accepted without price reduction.
- 6.4** If the Bridge Engineer determines that the steel is usable, a price reduction will be assessed against the contractor. The price reduction will be calculated using the following formula:

$$P = A \times B \quad \text{where:}$$

6 Failing Steel: (continued)

A = total invoice price of reinforcing steel in the lot.*

B = 10%, 20% or 30% dependent upon departure from specifications. The value to be used shall be determined by the Bridge Engineer.

P = Price reduction for the Lot.

* A lot is defined as all of the bars of one bar number and pattern of deformation contained in an individual shipment.

7 Standard Weights, Diameters and Number Designations:

7.1 The standard weights and diameters of deformed reinforcing bars and their number designations shall be those listed in Table 1.

7.1.1 The three minimum yield levels of bars are: 40,000 psi; 60,000 psi; and 75,000 psi, designated as Grade 40, Grade 60, and Grade 75, respectively.

7.1.2 The nominal dimensions of a deformed bar are equivalent to those of a plain round bar having the same weight per foot as the deformed bar.

7.1.3 Bar numbers are based on the number of eighths of an inch included in the nominal diameter of the bars.

TABLE 1
English Version

Bar Size	Nominal Dia. Inches	Wt. Lb. Per Ft.	Minimum Sampling Frequency per Project
3	.375	.376	No sample for less than 2 tons 1 sample for ea. 5 tons or fraction
4	.500	.668	No sample for less than 5 tons 1 sample for ea. 40 tons or fraction
5	.625	1.043	No sample for less than 5 tons 1 sample for ea. 40 tons or fraction
6	.750	1.502	No sample for less than 5 tons 1 sample for ea. 85 tons or fraction
7	.875	2.044	No sample for less than 5 tons 1 sample for ea. 85 tons or fraction
8	1.000	2.670	No sample for less than 10 tons 1 sample for ea. 150 tons or fraction
9	1.128	3.400	No sample for less than 10 tons 1 sample for ea. 150 tons or fraction
10	1.270	4.303	No sample for less than 10 tons 1 sample for ea. 240 tons or fraction
11	1.410	5.313	No sample for less than 10 tons 1 sample for ea. 240 tons or fraction
14	1.693	7.650	One sample
18	2.257	13.600	One sample

TABLE 1
Metric Version

Bar Size	Nominal Dia. mm	Wt. Kg/m	Minimum Sampling Frequency per Project
10	9.5	0.560	No sample for less than 2 metric tons (t) 1 sample for ea. 5 metric tons (t) or fraction
13	12.7	0.994	No sample for less than 5 metric tons (t) 1 sample for ea. 36 metric tons (t) or fraction
16	15.69	1.552	No sample for less than 5 metric tons (t) 1 sample for ea. 36 metric tons (t) or fraction
19	19.1	2.235	No sample for less than 5 metric tons (t) 1 sample for ea. 77 metric tons (t) or fraction
22	22.2	3.042	No sample for less than 5 metric tons (t) 1 sample for ea. 77 metric tons (t) or fraction
25	25.4	3.973	No sample for less than 9 metric tons (t) 1 sample for ea. 136 metric tons (t) or fraction
29	28.7	5.060	No sample for less than 9 metric tons (t) 1 sample for ea. 136 metric tons (t) or fraction
32	32.3	6.404	No sample for less than 9 metric tons (t) 1 sample for ea. 218 metric tons (t) or fraction
36	35.8	7.907	No sample for less than 9 metric tons (t) 1 sample for ea. 218 metric tons (t) or fraction
43	43.0	11.38	One sample
57	57.3	20.24	One sample

**METHODS OF SAMPLING AND TESTING
MT 415-12
METHOD OF ACCEPTANCE FOR STRUCTURAL STEEL**

THIS PROCEDURE IS IN DEVELOPMENT

METHODS OF SAMPLING AND TESTING
MT 418-04
METHOD OF ACCEPTANCE FOR MISCELLANEOUS WELDED ITEMS
(MONTANA METHOD)

1 Scope:

1.1 This method is intended as a guide for the acceptance of miscellaneous, low stress carrying welded items. It does not cover any welding in connection with bridge related items.

2 Referenced Documents:

2.1 Montana Department of Transportation Detailed Drawings

3 Field Welding Acceptance:

3.1 The low stress carrying members listed in 3.1.1, 3.1.2, and 3.1.3 below can be approved by the field provided the welding has been done by a qualified welder in accordance with AWS D1.1 Current edition, Limited Thickness. In the event that field welding is necessary, contact the Bridge Bureau for welder qualification tests.

3.1.1 Trash guard racks (MDT Detailed Drawing No. 615-02) and median inlet covers (MDT Detailed Drawing No. 604-00).

3.1.2 Guardrail terminal section anchor plates (MDT Detailed Drawing No. 606-86).

3.1.3 Ladders, stairways, scale pit angles, grates, and miscellaneous items associated with weigh stations, rest areas, and observation points.

4 Acceptance Procedure:

4.1 The procedure listed in 4.1.1, 4.1.2, 4.1.3, and 4.1.4 below must be followed for the acceptance of welded items covered in this method.

4.1.1 A copy of the mill test results must accompany the material.

4.1.2 A copy of the welder qualification form or other verification must accompany the material.

4.1.3 The items must be visually inspected and the welds examined for appearance, size, undercut, and porosity.

4.1.4 Items 4.1.1 and 4.1.2 must be attached to the visual inspection report and submitted in the usual manner.

METHODS OF SAMPLING AND TESTING
MT 420-04
PROCEDURE TO CHECK FOR LEAKS UNDER HYDROSTATIC PRESSURE

1 Scope

- 1.1 This procedure is used to determine the degree of water tightness for corrugated metal irrigation or siphon pipe and couplers. This test is customarily performed at the fabrication plant, but can also be performed in the field.

2 Apparatus and Equipment

- 2.1 Bulkheads shall consist of the following:
- 2.1.1 A two-foot section of corrugated steel pipe of the specific diameter to be tested. Pipe sections with helical corrugations shall be re-rolled at the outer ends to form at least two corrugations to fully accommodate band couplers.
 - 2.1.2 Two squares pieces of 1/8 inch thick steel plate, with a dimension four inches greater than the diameter of the pipes to be tested.
 - 2.1.3 Four lengths of 2 inch x 2 inch x ¼ inch steel angles to be used as braces with a length equal to the dimension of the plates.
 - 2.1.4 One – 3 inch galvanized steel elbow.
 - 2.1.5 One – 3 inch galvanized cap with a ¾ inch threaded hole at center.
 - 2.1.6 One – ¾ inch, or longer, gate valve to accommodate a water hose.
 - 2.1.7 Two full length section of culvert.
 - 2.1.8 Three approved band couplers with appropriate gaskets.
 - 2.1.9 2 inch x 4 inch wood bracing blocks 3 feet in length.
- 2.2 The bulkheads consist of two 2-foot sections of corrugated steel pipe, of the diameter of the pipe to be tested, to which a braced 1/8 inch square plate has been welded to one end. One bulkhead is fitted with a 3 inch galvanized elbow. The elbow is welded vertically to the top of the plate. The horizontal leg of the elbow must be located directly below the trough of the culvert corrugation to prevent air entrapment (See Figure 1).
- 2.3 A 3 inch removable, galvanized filler cap with ¾ inch dia. hole at center is to accommodate a standpipe for observing the static pressure head applied (see Figure 1 & Figure 2).
- 2.4 A ¾ inch dia. Gate valve is to accommodate the pressurized hose attached to the bottom of the steel back plate. This valve is to provide a constant head of water in the stand pipe during the tests and also to serve as a drain after testing is completed (see Figure 1).
- 2.5 The stand pipe shall consist of the following:
- 2.5.1 Four – 5 foot sections of ¾ inch galvanized pipe.
 - 2.5.2 Three – ¾ inch galvanized tees.
 - 2.5.3 Three – ¾ inch galvanized plugs.
 - 2.5.4 One – 8 inch funnel.

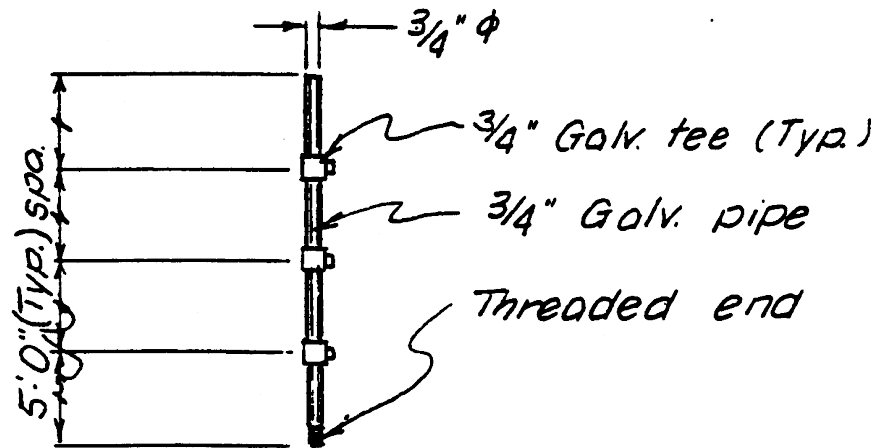
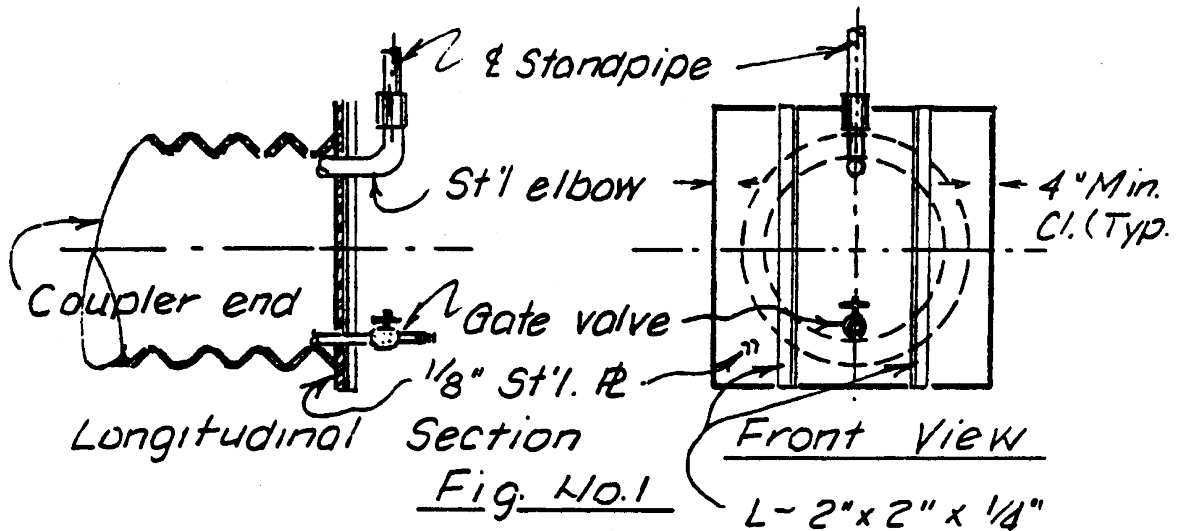

3 Procedure

- 3.1 After attaching the bulkheads to the culvert test sections, the sections are coupled together, braced at the center to prevent sagging, and are filled to capacity with water.
- 3.2 The 20 foot stand pipe (Figure 2) is assembled and attached to the 3 inch elbow filler cap.
- 3.3 Water is introduced into the stand pipe from the bottom by means of the gate valve.
- 3.4 With water flowing continuously out of the first or bottom tee, and after waiting for a period of five minutes, a close examination is made of the test section for evidence of leakage.
- 3.5 The tee is plugged and the process repeated at each five foot increment until water flows out of the top of the stand pipe, the maximum twenty foot head.
- 3.6 A slight indication of "sweating" or "seepage" at the test seams is permissible for irrigation pipe. Dripping or free flow of water is not acceptable. No sweating or other seepage for siphon pipe applications is permissible. If only the pipe seams are being tested but not the bands, some leakage at the bands may be allowed.

4 Frequency of Test

- 4.1 Each diameter of pipe at least once a year at the discretion of the inspector.

METHODS OF SAMPLING AND TESTING
MT 421-09
METHOD OF SAMPLING CONSTRUCTION FABRICS

1 Scope

- 1.1 This method covers the sampling of Geosynthetics. Geosynthetics generally fall into one of the following categories; woven and non-woven Geotextiles, Geogrids, Geocomposites, Geomembranes and Geosynthetic Clay Liner (GCL).

2 Description

- 2.1 Geotextiles are permeable materials comprised of fibers or yarns combined into planar textile structures. The majority are either woven or non-woven (as described below) and are used for strength, separation, drainage, filtration and erosion control purposes.

Woven – Geotextile that are typically made of monofilament, multifilament or fibrillated yarns.

Non-woven – Geotextile that is manufactured using a process in which synthetic polymer fibers are continuously extruded and spun. The fibers or filaments are then connected by needle punching or heat bonding.

- 2.2 Geogrid consists of polymer mats constructed either of coated yarns or punched and stretched polymer sheets that allow interlocking of surrounding geomaterials and are commonly used for soil reinforcement.
- 2.3 Geocomposites generally consist of a geonet or a cusped or dimpled polyethylene drainage core wrapped in a geotextile and are often used as edge drains, wall drains, vertical drains (wick drains), and sheet drains.
- 2.4 Geomembranes consist of impervious polymer sheets that are typically used to line ponds, ditches, and landfills.
- 2.5 Geosynthetic Clay Liners (GCL) are manufactured hydraulic barriers consisting of sodium bentonite clay sandwiched and binded between two geotextiles or attached with an adhesive to a geomembrane. Overlaps self-seal when the sodium bentonite hydrates. GCL's are commonly used to control vertical or horizontal infiltration of moisture.

3 Referenced Documents**AASHTO**

M 288 Geotextile Specification for Highway Applications

ASTM

D4354 Sampling of Geosynthetics for Testing

MT Geotechnical Manual**4 Sample**

- 4.1 Prior to installation of the geosynthetic the following requirements are necessary to insure proper selection for each type of application:
- 4.1.1 The contractor shall submit to the EPM two copies of a notarized manufacturer's certificate of compliance signed by a legally authorized official of the manufacturer and notarized. The certification shall represent physical and chemical test results that were performed on a representative lot of material being used by the department.
- 4.1.2 In addition to certifications, a sample for Acceptance testing is required.

- 4.1.3 All sampling of geosynthetics, will be done at the project and witnessed by the EPM or his designee, for each type of application, i.e., geotextiles: separation, stabilization, subsurface drainage (Class A, B, or C) permanent erosion control (Class A, B, or C), silt fence (stabilized or unstabilized), geogrids, geocomposites GCL's and geomembranes. Compare the manufacturer's certificate of compliance to the specifications for the proposed application to ensure product compliance prior to acceptance and installation. Submit samples with certifications to the Materials Bureau for testing.
- 4.1.4 The size of sample for each application will be a minimum 4 foot wide strip cut across the full roll taken from a wrap of geosynthetic not exposed to sunlight or abrasion (see Note 1).
- 4.1.5 Frequency of sampling shall be one sample for every 10,000 square yards (8,000 m²) of application.
 - 4.1.5.1 Each new roll used will be checked for variance of lot number and then, if necessary, resampled and submitted to the Materials Bureau for testing. (See Note 2)
 - 4.1.5.2 The direction of roll must be identified on the sample.

Note 1 – The sample must be cut so that the cut edge is perpendicular to the roll (machine) direction. It is important to identify the roll direction on the sample, as the direction of failure in the fabric must be identified.

Note 2 – Label the sample with the manufacturer's lot number and identification of fabric type, grade or product name, date of sampling, project number and sample number.

5 Shipment and Storage

- 5.1 Each geosynthetic roll shall be wrapped with a material that will protect the geosynthetic, including the ends of the roll, from damage due to shipment, direct sunlight, ultra-violet radiation and contaminants. The protective material shall be maintained during shipping and storage.
- 5.2 During storage, geosynthetic rolls shall be elevated off of the ground and adequately covered to protect them from the following: site construction damage, precipitation, extended ultraviolet radiation including sunlight, chemicals that are strong acids or bases, flames including welding sparks, temperatures in excess of 160° F (71° C), and other environmental conditions that may damage the physical properties of the geosynthetic.

6 Specifications

- 6.1 For basis of acceptance and testing requirements refer to the Standard Specifications for Road and Bridge Construction. Since the Materials Bureau has a strict acceptance policy, proper sampling and correct submittal is essential.

METHODS OF SAMPLING AND TESTING
MT 422-12
METHOD OF TEST FOR SURFACE SMOOTHNESS AND PROFILE

1 Scope:

- 1.1 This method covers the testing of a finished flexible pavement surface for smoothness and profile. The surface smoothness is expressed in International Roughness Index (IRI) in units of inches per mile. The surface profile is generated to locate variations in profile (e.g., bumps or dips). This method is not intended to be used with rigid pavement or gravel surfacing.

2 Reference Documents:

- 2.1 Operator's Manual, Surface Systems & Instruments, LLC
Profiler Operations Manual (POM) for MDT Profilers (most recent version)
MDT QC/QA Plan (most recent version)

3 Terminology:

- 3.1 International Roughness Index (IRI) – An index resulting from a mathematical simulation of vehicular response to the longitudinal profile of a pavement using a 'quarter-car' simulation model as described in NCHRP Report 228.

4 Apparatus:

- 4.1 Class I laser road profiler as defined in ASTM E950. The road profiling system is mounted on a vehicle, usually a van or truck. It consists of the following components:
- 4.1.1 Vertical, non-contact, height measurement systems (i.e., laser) capable of measuring the height from the mounted sensor face to the surface of the pavement.
- 4.1.2 A linear distance measuring system (i.e., DMI) capable of measuring distance traveled.
- 4.1.3 An inertial referencing system (i.e., accelerometers) capable of measuring the movement of the vehicle as it traverses the pavement.

5 Software:

- 5.1 The software must activate the testing using parameters (i.e., data collection initiation) that are stored by the control setup.
- 5.2 The software must receive, display, and store raw data received from the profiler.
- 5.3 The software must be capable of accumulating desired output and printing results.

6 Calibration:

- 6.1 Perform a comprehensive calibration and sensor check at thirty (30) day intervals during construction season. Check the DMI and verify Laser each day before use.
- 6.2 Calibration is used to establish and adjust the operating characteristics of the SSI system. There are five (5) items that will either be calibrated or checked: laser height, distance measuring device, tire pressure, Accelerometer and Bounce Test.
- 6.3 Check tire pressure and inflate to manufacturer's recommended psi. Special care should be given to the tire on which the DMI device is mounted.

6 Calibration: (continued)

6.4 Laser Height Verification

- 6.4.1 The lasers have been calibrated at the factory. The lasers can only be verified.
- 6.4.2 A verification check of the laser will be performed each day before use.
- 6.4.3 A full verification check of the laser sensors must also be performed whenever problems are suspected, or when a sensor is repaired or replaced.

6.5 Facility for Laser Height Verification

- 6.5.1 Each MDT District should have a facility available (e.g.; enclosed garage at District).
- 6.5.2 Facility should have a level surface and be free of vibration.

6.6 Procedure for Laser Height Verification

- 6.6.1 Verify laser height in accordance with section 3.3 (pages 15-16) of the SSI Operations Manual.

6.7 Accelerometers

- 6.7.1 Accelerometers need an occasional static verification. Perform static verification (1) every 30 days during times when the system is used frequently, (2) after any prolonged period that the system has not been used, (3) when repairs are performed on the accelerometer(s) or associated system, or (4) any time the system is generating data that appears erroneous or suspect.

6.8 Facility for Accelerometer Verification

- 6.8.1 Each MDT District should have a facility available (e.g.; enclosed Garage at District).
- 6.8.2 Facility should have a level surface and be free of vibration.

6.9 Procedure for Accelerometer Verification

- 6.9.1 Perform the Accelerometer verification as per section 3.6 (page 21) of the SSI Operations Manual.

6.10 Bounce Test

- 6.10.1 The bounce test is a controlled-conditions procedure that uses the profiler's built-in simulation capabilities to test that the profiling system is operating properly. Perform the bounce test (1) every 30 days during times when the system is used frequently, (2) after any prolonged period that the system has not been used, (3) when repairs are performed on the associated system, or (4) any time the system is generating data that appears erroneous or suspect.

6.11 Facility for Bounce Test

- 6.11.1 Each MDT District should have a facility available (e.g.; enclosed garage at District).
- 6.11.2 Facility should have a level surface and be free of vibration.

6.12 Procedure for Bounce Test

- 6.12.1 Perform the Bounce Test as per sections 3.4 and 3.5 (page 17) of the SSI Operations Manual.

6.13 Distance Measuring Instrument (DMI)

6.13.1 Calibrate DMI whenever problems are suspected, the tires are replaced, suspension repairs are performed, wheels are rotated/ aligned, or repairs are performed on the DMI.

6.14 DMI Calibration Site

6.14.1 Each MDT District should have a calibration site established.

6.14.2 This site should be located on a straight portion of roadway that is reasonably level and has low traffic volume.

6.14.3 The site should be measured with a standard surveying tape or wheel (using standard surveying procedures), or laid out using an electronic distance measuring system.

6.15 Procedure for DMI Calibration

6.15.1 Calibrate the Distance Measuring Instrument (DMI) as per section 3.2 (pages 14-15) of the SSI Operations Manual.

6.16 Record Keeping

6.16.1 SSI software has a Calibration/Verification Report that Tracks DMI Calibration and Accelerometer Verification dates. That report may be printed from any Data Analysis files you may have. A simple record of all calibrations and verifications can be kept with the machine as per attached. (SEE "Calibration and Run Information" form)

7 Project Testing:

7.1 Preparation of Surface

7.1.1 Test the roadway only when it is free of moisture and any deleterious material that will not provide accurate test results.

7.1.2 The Contractor is responsible for all work to prepare the roadway for testing, such as, but not limited to sweeping off of debris.

7.1.3 Do not conduct testing while it is raining or under other weather conditions determined inclement by the Engineering Project Manager (EPM).

7.2 Project Setup

7.2.1 Engineering Project Manager (EPM) or one of his/her representatives will meet with the Contractor and identify the Beginning-of-Project (BOP), the End-of-Project (EOP), and all excluded areas (e.g., bridges not paved, curves with short radii).

7.2.2 If possible, project should be marked for testing using reflective tape or reflective traffic cones. This is the preferred method. There are two other acceptable methods: back-up to start or manual.

7.2.3 If it is not feasible to use the photocell to initiate and stop data collection, data collection can be initiated and stopped manually. When manually initiating and stopping profile data collection, cones should be placed at the beginning and end of the project to be used as reference points by the operator.

7.3 Profiler Operations

7.3.1 Operation of profiler should be consistent with guidelines discussed in the latest version of the SSI Profiler Operations Manual. This includes but is not limited to the following:

- Run in English unit system.
- If possible, initiate data collection via reflective surface and photocell.
- Use approved file naming convention. (Contract#_Lane Direction_Lane_Run#) example
09610_NB_DR_Run1
- Document any issues that occurred during testing.
- Process data with software.
- Properly backup data.
- Provide report to EPM or one of his/her representatives.

7.3.2 MDT collects two comparable runs.

- Once the operator is confident that a minimum of two comparable runs have been obtained, the Quality Control Review and Bump Reports are used to evaluate their acceptability. Profiler runs should satisfy the following criteria:
- The average IRI values at each 1 mi (1.61 km) interval for each of the two runs are within $\pm 5.7\%$ of the mean IRI of both runs.
- If spikes (e.g., unusually high IRI) are present in the data, the operator should determine if spikes are pavement related or the result of equipment or operator error. The operator should examine the profile bump reports for discrepancies and features that cannot be explained by observed pavement features.
- Rerun the entire project if any one mile section does not match within the 5.7% tolerance established in 7.3.2.1.1 and compare that run to the previous runs.
- Use the results of the two runs that compare for project acceptance.
- If the third run does not compare to either of the first two runs, recheck all calibrations and then rerun the entire project and compare the results to the previous runs. Use the two runs that compare favorably.

7.4 Testing Results

7.4.1 Results shall be provided to EPM or one of his/her representatives and shall be processed into desired segments (e.g., 0.5 miles) as described in the contract Ride Specification.

7.4.2 A Roughness Report will be generated for the first profile run deemed to be within the comparison values for each lane profiled. This report will contain the IRI values for the left and right wheel paths. These IRI values will be applied to the most recent pay incentives/disincentives as described in Ride Specification.

7.4 Testing Results: (continued)

- 7.4.3** A Bump Report will be generated for the first profile run deemed to be error free for each lane profiled. The Bump Report will indicate the locations of potential defects. These will be reviewed with the EPM. Location should be physically examined to determine if, at the EPM's discretion, the location should be considered a defect.

**CURRENT DATE OF REVISION
MT 500 SECTION
CHEMISTRY**

<u>Test Method No.</u>	<u>Title</u>	<u>Pages</u>	<u>Date of Publication or Revision</u>
MT 501	pH, Insoluble Materials, Corrosion Rate, Percent Settleable Solids and Percent Passing a #10 Sieve of Brine Materials.....	1 pp	Jun 2016
MT 502	Elemental Chemical Analysis Of Brine Materials.....	7 pp	Sep 2016
MT 503	Vacant		
MT 504	Cyanide In Brine Material.....		Under Development
MT 505	Vacant		
MT 506	Vacant		
MT 507	Vacant		
MT 508	Vacant		
MT 509	Vacant		
MT 510	Vacant		
MT 511	Vacant		
MT 512	Vacant		
MT 513	Vacant		
MT 514	Vacant		
MT 515	Vacant		
MT 516	Vacant		
MT 517	Vacant		
MT 518	Vacant		
MT 519	Vacant		
MT 520	Determination of Wear Metals in Engine Oil.....		Under Development
MT 521	Testing Dyed Diesel.....	1 pp	Sep 2016
MT 522	Vacant		
MT 523	Vacant		
MT 524	Vacant		
MT 525	Mechanical Rocker Test for Ice Melting Capacity for Deicing Material	5 pp	Aug 2019
MT 526	Moisture Analysis of Clear Roads Category 8A, 8B, and 8C Solid Sodium Chloride.....	2 pp	Jun 2016
MT 527	Vacant		
MT 528	Vacant		
MT 529	Vacant		

**CURRENT DATE OF REVISION
MT 500 SECTION
CHEMISTRY**

<u>Test Method No.</u>	<u>Title</u>	<u>Pages</u>	<u>Date of Publication or Revision</u>
MT 530	Determination of Chloride in Bridge Deck Cement by Ion Chromatography	5 pp	Dec 2016
MT 531	Vacant		
MT 532	Determination of Sulfate Content in Soils by Ion Chromatography	4 pp	Dec 2016
MT 533	Chemical Analysis of Fly Ash and Pozzolans	9 pp	Sep 2016
MT 534	Chemical Analysis of Portland Cement.....	8 pp	Jun 2016
MT 535	Bridge Deck Crack Sealant IR Test		Under Development
MT 536	Chemical Analysis of Silica Fume	1 pp	Jun 2016
MT 537	Chemical Analysis of Ground Granulated Blast-Furnace Slag (GGBFS).....	4 pp	Sep 2016
MT 538	Chemical Analysis of Blended Cement.....	9 pp	Sep 2018
MT 539	Vacant		
MT 540	Vacant		
MT 541	Vacant		
MT 542	Vacant		
MT 543	Vacant		
MT 544	Vacant		
MT 545	Vacant		
MT 546	Vacant		
MT 547	Vacant		
MT 548	Analysis of Traffic Paint.....	7 pp	Jun 2016

METHODS OF SAMPLING AND TESTING
MT 501-16
pH, INSOLUBLE MATERIAL, CORROSION RATE, PERCENT SETTLEABLE SOLIDS AND
PERCENT PASSING A NO. 10 SIEVE OF BRINE MATERIALS
(Montana Method)

MT 501 is identical to the 2010 Clear Roads Snow and Ice Control Chemical Products Specifications and Test Protocols (<https://clearroads.org/wp-content/uploads/12-10-Final-CR-SPECS-wCategory4.pdf>) except for the following stipulations:

Test Method C

- 1 Perform a prescreening procedure for the Percent Total Settleable Solids methods.
- 1.1 Pour a well-mixed sample into a 50 ml conical bottom disposable vial to the 50 ml mark. Cap vial. Repeat for all samples. Place the vials in a freezer at the test temperature designated below for 168 hours:
 - Sodium Chloride: $-17.8^{\circ}\text{C} \pm 1^{\circ}\text{C}$ ($0^{\circ}\text{F} \pm 2^{\circ}\text{F}$)
 - Magnesium Chloride: $-17.8^{\circ}\text{C} \pm 1^{\circ}\text{C}$ ($0^{\circ}\text{F} \pm 2^{\circ}\text{F}$)
 - Calcium Chloride: $-29^{\circ}\text{C} \pm 1^{\circ}\text{C}$ ($-20^{\circ}\text{F} \pm 2^{\circ}\text{F}$)

Note 1 – Ensure the samples remain free from agitation or disturbance during the entire testing duration.

- 1.2 At the end of the testing time (168 hours), observe samples. If any noticeable hardening or crystallization of the deicer is observed, then perform additional testing in accordance with Clear Roads Test Method C. If the sample does not exhibit hardening or crystallizing the sample passes the test.
- 2 Report
 - 2.1 Report settleable solids as a (V/V) percent $\pm 0.1\%$ in Site Manager.
 - 2.2 Report solids passing through a number 10 sieve as a (V/V) percent $\pm 0.1\%$ in Site Manager.

METHODS OF SAMPLING AND TESTING
MT 502-16
ELEMENTAL CHEMICAL ANALYSIS OF BRINE MATERIALS
(Montana Method)

1 Scope

- 1.1 This test method describes the procedures used to analyze brine materials for the following analytes: arsenic (As), barium (Ba), cadmium (Cd), chromium (Cr), copper (Cu), phosphorus (P), lead (Pb), mercury (Hg), selenium (Se), and zinc (Zn) in brine materials. Additionally the samples are analyzed for magnesium (Mg), sodium (Na), and sulfur (S) to determine the percentage of magnesium chloride, sodium chloride, and sulfates in the samples.
- 1.2 This standard involves hazardous materials, operations, and equipment. This standard does not purport to address all of the safety concerns associated with its use. It is the responsibility of the user of this procedure to establish appropriate safety and health practices and to determine the applicability of regulatory limitations prior to use.

2 Referenced Documents**ASTM**

D1193 Standard Specification for Reagent Water

Milestone

Milestone Grease Digestion Application Note HPR-CH-16

3 Summary of Test Method

- 3.1 Samples are prepared using a microwave digestion technique based on Milestone Grease Digestion Application Note HPR-CH-16. Mercury is analyzed using a cold vapor technique with a vapor generation assembly (VGA) attached to a flame atomic absorption spectrometer (FAAS). All other analytes are analyzed using an inductively coupled plasma – optical emission spectrometer (ICP-OES).

4 Significance and Use

- 4.1 This procedure is primarily used to provide quality assurance and control for deicer materials and dust palliatives.

5 Apparatus

- 5.1 *Analytical Balance* – with a precision of 0.0001 g
- 5.2 *Microwave digestion system* – Capable of heating samples to 200°C and maintaining that temperature for at least 30 minutes. The system must use sealable vessels that prevent the escape of vapors.
- 5.3 *ICP-OES* – Capable of measuring analytes of interest at parts per million (ppm) levels and low parts per billion (ppb) levels
- 5.4 *Flame Atomic Absorption Spectrometer (FAAS)* – Equipped with a hollow cathode lamp (HCL) for measuring Hg and capable of operating with an attached VGA
- 5.5 *Vapor Generation Assembly (VGA)* – Capable of cold vapor techniques for detecting mercury at low ppb to high parts per trillion (ppt) levels
- 5.6 *Labware* – Glassware, Teflon, and Plasticware containers that have been properly cleaned and stored filled with dilute nitric acid solution (1 – 5%) for at least 2 days.

6 Reagents and Materials

- 6.1 Trace metal grade (TMG) hydrochloric acid (HCl) – concentration of 32-38%
- 6.2 TMG nitric acid (HNO₃) – concentration of 65-70%
- 6.3 Technical grade hydrogen peroxide (H₂O₂) – concentration of 34-37%
- 6.4 Stannous chloride solution - 10% stannous chloride (SnCl₂) w/v and 20% TMG hydrochloric acid
- 6.5 1+1 hydrochloric acid – Made with TMG HCl (e.g., Add 500 ml TMG HCl to 400 ml reagent water and dilute to 1 L).
- 6.6 Reagent Water – Purified water that meets ASTM Type II specifications or better (ASTM D1193)

7 Calibration and Standardization

Follow manufacturer's specifications for calibrating and standardizing the ICP-OES and VGA. Appendix A provides calibrating and standardizing specifications for a Varian Axial View ICP-OES, an Agilent Radial View ICP-OES, and Varian VGA.

8 Procedure

- 8.1 Tare a clean microwave digestion vessel on the analytical balance. Use a transfer pipet to dispense a portion of the sample into a digestion vessel in accordance with the table below. Record the mass.

Material Being Analyzed	Amount of material (grams)
Corrosion Inhibitor	1.2
Sodium Chloride Magnesium Chloride Calcium Chloride	7.5

Note 1 – Use a small weighing dish in place of a microwave digestion vessel when static electricity prevents a stable measurement. Transfer contents to a microwave digestion vessel; use a small amount of water to rinse the contents of the weighing dish.

- 8.2 In a ventilation hood, add 1 mL of hydrogen peroxide and 9 mL of nitric acid to each of the digestion vessels. Assemble the digestion vessels and all other components required for proper microwave digestion in accordance with the manufacturer's instructions and then run the digestion program. MDT's parameters for a Milestone Ethos EZ microwave digestion system are in Appendix A.
- 8.3 After completion of the digestion program, allow the carousel to cool before removing. The carousel may be left overnight to cool.
- 8.4 Remove a digestion vessel and open it. Rinse the sample into a clean Teflon beaker or other suitable cleaned container. Tare an appropriate storage container on the analytical balance. Rinse the sample into the storage container. Place the storage container back onto the analytical balance and dilute with reagent water until a mass of 100.00 g ± 0.05. Record the mass to nearest 0.01 g. Repeat for all samples.
- 8.5 Label the sample bottles with the sample number, date, analyst initials, and as Brine Material stock solution.

- 8.6 Dilute the stock solutions with reagent water for the analysis of Mg, Na, and S to 1:100 by weight. Label the dilute samples with the sample number, date, analyst initials, and as Brine Material dilute solution.
- 8.7 Analyze the stock and dilute samples on the radial view ICP-OES, axial view ICP-OES, and VGA with FAAS, as appropriate.

9 Calculation or Interpretation of Results

9.1 Concentration Calculations

9.1.1 As, Ba, Cd, Cr, Cu, P, Pb, Se, and Zn (measured in mg/kg by the ICP-OES)

Sample concentration is calculated by multiplying the measured value by a ratio of the solution weight divided by the sample weight.

$$C = DM \left(\frac{L}{S} \right)$$

Where:

C = sample concentration (mg/kg)

M = measured value (µg/kg)

L = solution mass

S = sample mass

D = dilution factor that is equal to 1 for final products or is equal to 100%/P where P is the percentage of the component of interest in the final product

Note – Concentration calculations for corrosion inhibitors requires the inclusion of a dilution factor based on the amount of inhibitor used in the product.

9.1.2 Hg (measured in µg/kg by the VGA)

Mercury concentration is calculated by multiplying the measured value by a ratio of the solution mass divided by the sample mass then divided by 1000.

$$C = \frac{ML}{1000S}$$

Where:

C = sample concentration in mg/kg

M = measured value in µg/kg

L = solution mass

S = sample mass

9.2 Percent Weight Calculations

$$P = \frac{LMNO}{10000STU}$$

Where:

P = percent weight of the desired compound

L = mass of the first solution

M = measured value of the analyte in mg/kg

N = mass of the second solution

O = molecular mass of the desired compound

S = sample mass

T = mass of the aliquot from the first solution

U = atomic mass of the measured analyte.

Elements and molecules	Atomic mass	Molecular mass
Na	22.99	
NaCl		58.44
Mg	24.31	
MgCl ₂		95.21
S	32.066	
SO ₄		96.066

10 Report

10.1 Elements As, Ba, Cd, Cr, Cu, Hg, P, Pb, Se, and Zn – report as mg/kg

10.2 MgCl₂, NaCl, and SO₄ – report as percent by weight of the product

**APPENDIX A
ANALYTICAL INSTRUMENTATION CALIBRATION**

Milestone Ethos EZ microwave digestion system

Digestion program used: motoroil.mpr

Heat and time: Heat to 200°C and hold temperature during a 30 minute interval. Follow by a 10 minute cooling period.

Rotor: SK-10

Varian Axial View ICP-OES configuration parameters for brines and non-inhibitorsEquipment Configuration

- a. Nebulizer: Sea Spray
- b. Spray chamber: cyclonic
- c. Sample pump tubing: White/White
- d. Waste pump tubing: Blue/Blue
- e. Rinse Solution: 3% Nitric Acid
- f. Torch: High solids with sheath gas
- g. Sheath gas: Argon at 10mL/min
- h. Power: 1.20 kW
- i. Plasma flow: 15.0 L/min
- j. Auxiliary flow: 1.50 L/min
- k. Nebulizer flow: 0.70 L/min for MgCl₂ brines 0.80 L/min for NaCl brines
- l. Replicate Read time: 10.00 s
- m. Instrument stabilization delay: 15.00s
- n. Sample uptake delay: 30.00s
- o. Pump rate: 15 rpm
- p. Rinse time: 100s
- q. Fast pump: yes
- r. Replicates: 3

Line Selection for Standard, Samples, and Blanks:

- a. As 193.696
- b. Ba 233.527
- c. Cd 214.439
- d. Cr 267.716
- e. Cu 324.754
- f. P 213.618
- g. Pb 220.353
- h. Se 196.026
- i. Zn 213.857

Calibration Varian Axial ICP-OES

- a. Type: Linear for all elements
- b. Linear-Maximum percent error of 5% except Cd that can be 15% and confidence limit of 0.99%
- c. Calibration standards: Prepare calibration standards and blanks so that the sample matrices are being mimicked by compensating for the content of acids and salts. Prepare a total of one standard blank and three standards with varying concentrations of each desired analyte.

Agilent Radial View ICP-OES configuration parameters for brines and inhibitorsEquipment configuration

- a. Nebulizer: One Neb
- b. Spray chamber: cyclonic
- c. Sample pump tubing: White/White
- d. Waste pump tubing: Blue/Blue
- e. Rinse solution: 3% Nitric acid
- f. Torch: High solids
- g. Power: 1.15 kW MgCl₂ brines, 1.20 kW NaCl brines, and 1.10 kW for inhibitors.
- h. Plasma flow: 15.00 L/min
- i. Auxiliary flow: 1.50 L/min
- j. Nebulizer flow: 0.80 L/min MgCl₂ brines, 0.75 L/min NaCl brines, and 0.70 L/min for inhibitors.
- k. Viewing height: 11 mm MgCl₂ brines, 12 mm NaCl brines, and 9 mm for inhibitors.
- l. Replicate read time: 10.00s
- m. Instrument stabilization delay: 15s
- n. Sample uptake delay: 30s
- o. Pump rate: 15s
- p. Rinse rate: 10s
- q. Fast pump: yes
- r. Replicates: 3

Line selection for standards, samples and blanks:*MgCl₂ brines*

- a. Mg 280.270
- b. Na 589.592
- c. S 181.972

NaCl brines

- a. Na 589.592

Corrosion Inhibitors

- b. As 188.980
- c. Ba 455.403
- d. Cd 226.502
- e. Cr 205.560
- f. Cu 324.754
- g. P 213.618
- h. Pb 220.353
- i. Se 196.026
- j. Zn 213.857

Calibration Agilent Radial ICP-OES

- a. Type: Linear for all elements
- b. Linear-Maximum percent error of 5% and confidence limit of 0.99%.
- c. Calibration standards: Prepare calibration standards and blanks so that the inhibitor sample matrices are being mimicked by compensating for the acids and inhibitor components. For the brines only compensate for the acid content. Prepare a total of one standard blank and three standards with varying concentrations of each desired analyte.

Varian AA 240FS and VGA configuration parameters

Equipment configuration

- a. Measurement time: 10.00s
- b. Read delay: 115s
- c. Sample tubing: Purple/black
- d. Acid and reductant tubing: black/black
- e. Replicates standards: 3
- f. Replicates samples: 3
- g. Precision % standards: 1.0
- h. Precision % samples: 1.0
- i. Lamp Current: Recommended current on Hg lamp
- j. Slit width: 0.5R nm
- k. Reslope rate: 50
- l. Reslope standard: number 2

Wavelength selection for standards, samples, and blanks

- a. 253.7 nm

Calibration Varian AA 240FS and VGA

- a. Type: Linear
- b. Calibration standards: Prepare calibration standards and blanks so that the acid content of the sample matrices are mimicked. Prepare a total of one standard blank and three standards with varying concentrations of each desired analyte.

Reagents

- a. Acid: Described in 6.5
- b. Reductant: Described in 6.4

**METHODS OF SAMPLING AND TESTING
MT 504-16
CYANIDE IN BRINE MATERIAL**

THIS PROCEDURE IS IN DEVELOPMENT

**METHODS OF SAMPLING AND TESTING
MT 520-12
DETERMINATION OF WEAR METALS IN ENGINE OIL**

THIS PROCEDURE IS IN DEVELOPMENT

METHODS OF SAMPLING AND TESTING
MT 521-16
METHOD OF TESTING DYED DIESEL
(Modified ASTM D6258)

MT 521 is identical to ASTM D6258 except for the following stipulations:

1. Add the following to Section 9.2.1:

Volume of Stock Standard/100 ml	Approximate Concentration of Working Standards
6.0 mL	18 mg/L
7.0 mL	21 mg/L

2. Add to the end of Section 9.5:

“Also measure the amplitude difference between the peak and valley of 580 ± 20 nm and 561 ± 20 nm.”

METHODS OF SAMPLING AND TESTING
MT 525-19
MECHANICAL ROCKER TEST FOR
ICE MELTING CAPACITY FOR DEICING MATERIAL
(Montana Method)

1 Scope

- 1.1 This procedure modifies the Mechanical Rocker Test for Ice Melt Capacity procedure developed by Nebraska Department of Transportation and the University of Nebraska-Lincoln to reflect research developments and improvements.
- 1.2 This document establishes a procedure for testing the ice melting capacity of liquid deicers and developing an ice melting curve over 90 minutes. The purpose is to provide a precise, accurate and repeatable test method to compare different liquid deicing products for effectiveness.
- 1.3 This procedure does not address the potential environmental impacts of liquid deicers such as pollution to roadside vegetation, soil, and run-off or damage to pavements due to corrosiveness of the deicers.
- 1.4 This procedure does not address the potential effects from natural conditions such as sunlight, wind speed, relative humidity, or other weather events experienced by field-applied deicers.
- 1.5 This procedure does not address detailed safety concerns of handling different deicer chemicals. It is the responsibility of the user to address any safety concerns that may arise.

2 Reference Documents

Nebraska Department of Transportation
Mechanical Rocker Test for Ice Melting Capacity (MRT or MRT-IMC), 2014
<https://dot.nebraska.gov/media/5752/final-report-m322.pdf>

3 Significance and Use

This test method describes procedures to be used for testing the ice melting capacities of chemical deicers to determine the effectiveness of different commercial deicing chemical products.

4 Apparatus and Materials**4.1 Mechanical Test Equipment**

- 4.1.1 *Laboratory Freezer* – The freezer must be large enough to hold at least four thermoses, one sieve, two ice trays, one funnel, a spatula, and tweezers. The freezer must be able to maintain a temperature of 0°F (-17.8°C) with an accuracy of ±2°C.
- 4.1.2 *Mechanical Rocker* – The mechanical rocker must be able to rock with a frequency range of 60 to 120 rpm. It must be capable of a tilt angle of ±10°. It must be able to hold the weight of at least ten lbs.
- 4.1.3 *Digital Mass Balance* – A digital mass balance in a confined box with ± 0.001 gram accuracy. A confining glass box is important to eliminate the error caused by air flow within the room.
- 4.1.4 *Stopwatch* – A digital stopwatch is required to record the rocking duration.

4.2 Sampling Equipment

- 4.2.1 *Latex Gloves* – A pair of latex gloves should be worn during the experiment.

- 4.2.2 *Thermos* – Four stainless-steel vacuum-insulated thermoses (16 oz. each) labeled A, B, C and D. It is important that the thermos be vacuum insulated. This obtains the highest insulation possible. The thermos should also be stainless-steel to protect against corrosion from the deicer due to multiple uses.
- 4.2.3 *No.4 Sieve* – A No. 4 sieve allows particles no larger than ¼ inch (6.4 mm) pass through its mesh. A sieve of a courser value may allow ice cubes to pass through, and a sieve of finer value may collect liquid on its mesh, allowing for melting to continue. Using other sized sieves is not recommended.
- 4.2.4 *Plastic Spatula and Plastic Tweezers* – A plastic spatula and plastic tweezers will be used to collect the residual ice chunks on the sieve.
- 4.2.5 *Styrofoam cups* – Eight 8 oz. Styrofoam cups or dishes that easily contain 33 ice cubes and fit in the mass balance. Styrofoam as a material is important because of its insulation properties. Styrofoam was chosen as a material to eliminate the error caused by condensation when weighing the cup. If the reading of the mass balance increases significantly over time, the environment might be too humid such that the condensation on the cup or dish could cause significant error in the measurements.
- 4.2.6 *Two ice cube trays* – Ice cube trays must produce ice cubes that have a cross-section of 7/16 in × 7/16 in (1.1 cm × 1.1 cm) and a depth of 7/16 in (1.1 cm). The ice cube trays must be able to make 140 ice cubes total (33 ice cubes for 4 samples and at least 8 extras in case any are damaged or defective.)
- 4.2.7 *Micropipette* – The micropipette must be able to deliver 1.3 ml of water in a single delivery within the ±0.10 ml tolerance.
- 4.2.8 *Pipette* – A volumetric pipette must be able to deliver 30 ml of deicer chemical with a tolerance of ±0.03 ml.
- 4.2.9 *Funnel* – A working funnel must allow for the ice cubes to pass through its small-end hole. The funnel's small end diameter must not be less than 1 in (2.5 cm).
- 4.2.10 *Deicer Chemical* – Any deicer liquid that can stay in liquid form at or below 0°F (-17.8°C).

5 Testing Procedures

- 5.1 Put on latex gloves before testing.
- 5.2 Sample Preparation
- 5.2.1 Label eight Styrofoam cups: A, B, C, D and AA, BB, CC, DD.
- 5.2.2 Label four thermoses: A, B, C, and D.
- 5.2.3 Prepare ice cubes. Use the micropipette to dispense 1.3 mL of distilled/deionized water into the apertures of the ice cube trays to create 140 ice cubes. Thirty-three ice cubes are required for a single sample and four samples will be analyzed for each test. Eight extra ice cubes should be prepared in case some are damaged or do not freeze entirely.
- 5.2.4 After filling the ice cube trays, tap the sides of the tray gently to vibrate the liquid inside the tray. This breaks the surface tension of the water and ensures that all the ice cubes will freeze properly. Ice cubes that do not freeze properly will appear as unfrozen liquid or slush.
- 5.2.5 Prepare deicer sample. Use the pipette to dispense 30 mL of a given liquid chemical deicer into each of the four thermoses labeled A, B, C, and D. Make sure to shake or stir any container containing the liquid deicer chemical before dispensing into the thermoses.
- 5.2.6 Measure and record the mass of the eight Styrofoam cups labeled A, B, C, D and AA, BB, CC, DD using the digital mass balance.

- 5.2.6.1 Styrofoam cups A, B, C, and D will be used for the measurement of the mass of ice before rocking.
- 5.2.6.2 Styrofoam cups AA, BB, CC, and DD will be used to measure the mass of melted ice after rocking.
- 5.2.7 Place the thermoses and the ice cube trays in the freezer with the temperature set at 0°F (-17.8°C). Place the lids of the thermoses over the openings of the thermoses, but do not secure the lids. Place the No. 4 sieve with bottom pan, a funnel, tweezers, and a spatula in the freezer. Place the Styrofoam cups labeled A, B, C, and D in the freezer. **Do not place the Styrofoam cups labeled AA, BB, CC, and DD in the freezer.** Allow all materials to acclimate and the ice to freeze for 24 hours.
- 5.3 Testing
- 5.3.1 Working inside the freezer, place 33 ice cubes inside Styrofoam cup A. The plastic funnel may be used to guide the ice cubes to fall into the cup.
- 5.3.2 Remove Styrofoam cup A filled with the ice from the freezer and place it within the mass balance. Measure and record the mass of cup A and the ice and place cup A and the ice back into the freezer. The reading on the mass balance should be recorded quickly within 30 seconds from the time the cup leaves the freezer.
- 5.3.3 Repeat steps 5.3.1 and 5.3.2 for Styrofoam cups B, C, and D.
- 5.3.4 Set the mechanical rocker's tilt angle to 10° and the frequency to 90 rpm.
- 5.3.5 Working within the confines of the freezer, remove the lid of the Thermos A and pour the 33 ice cubes from Styrofoam cup A into Thermos A, using the funnel to guide the ice cubes. Secure the lid of the thermos. Verify all the ice cubes are in the thermos as the ice cubes may stick to the cup or the funnel. Also, make sure to tighten the lid securely to prevent leaking during the rocking motion. Repeat this step for Thermos B, C and D.
- 5.3.6 Remove Thermos A, B, C and D from the freezer and place them on the mechanical rocker perpendicular to the rocking axis. Start the rocker and the stopwatch immediately afterwards. This step should not take more than 15 seconds.
- 5.3.7 Let the thermoses rock for 15 minutes for Thermos A, 30 minutes for Thermos B, 60 minutes for Thermos C and 90 minutes for Thermos D.
- 5.3.8 At the end of 15 minutes, remove Thermos A from the rocker. Remove the lid from Thermos A and pour its contents onto the No.4 sieve within the confines of the freezer. This step will separate the liquid from the remaining ice. Verify all the ice is dispensed from Thermos A onto the sieve. Gently tap the sides of the thermos to remove excess ice, and/or use the plastic tweezers and spatula to remove trapped ice, if necessary.
- 5.3.9 Place cup AA within the confines of the freezer and use the tweezers and/or spatula to move the ice from the No. 4 sieve to the cup. If the spatula is used to slide the ice into the cup, move no more than two ice cubes at a time to reduce the amount of liquid carried to the cup. In order to reduce ice melting, the ice cubes should be moved off the sieve and into cup AA as quickly as possible. No more than 90 seconds should pass from the time the thermos is removed from the rocker in Step 5.3.8 to the time the melted contents are moved from the sieve to cup AA. Cup AA should not have been allowed to acclimate with the rest of the testing materials in the freezer. Once inside cup AA, any melting that occurs will not affect the final mass of the ice.
- 5.3.10 Measure and record the mass of cup AA with the remaining ice in the digital mass balance. Although the effect of condensation is low, the reading on the mass balance will increase as the material remains on the balance. Cup AA should be removed from the freezer with its mass recorded in less than 30 seconds.

- 5.3.11 Repeat steps 5.3.8 to 5.3.10 for Thermos B, Thermos C, and Thermos D at their respective time intervals as stated in step 5.3.7. Styrofoam cup BB corresponds with Thermos B, Styrofoam cup CC with Thermos C, and Styrofoam cup DD with Thermos D.
- 5.3.12 Repeat the Testing Procedure in Section 5 at least two more times to obtain triplicate test data. Once the Testing Procedure has been completed at least three times, proceed to the calculations.

6 Calculations

6.1 Mass of Ice Melted (m_{xn}), grams ice

Calculate the mass of ice melted for each sample analyzed for each replicate test. The mass of ice melted is mass of the ice before rocking minus the mass of ice after rocking. This will be calculated from measurements taken in steps 5.2.6, 5.3.2, and 5.3.10.

$$m_{xn} = (\text{mass cup X w/ice} - \text{mass of cup X}) - (\text{mass cup XX w/ice} - \text{mass of cup XX}) \quad (\text{Equation 1})$$

Where:

X = sample (A, B, C, or D)

n = replicate test number (i.e., n = 1, 2, 3*)

*Note – If more than triplicate testing is required, n will correspond to the number of tests performed.

6.2 Ice Melting Capacity (IMC_{xn}), grams ice/mL deicer

Calculate the ice melting capacity for each sample analyzed for each replicate test.

$$IMC_{xn} = m_{xn} / 30 \text{ mL} \quad (\text{Equation 2})$$

Where:

X = sample (A, B, C, or D)

n = replicate test number (i.e., n = 1, 2, 3*)

*Note – If more than triplicate testing is required, n will correspond to the number of tests performed.

6.3 Average Ice Melting Capacity (\overline{IMC}) – *Optional*

\overline{IMC} is the average of the replicate test IMC_{xn} (Equation 2) at each time interval. The averages of the four time intervals can be plotted to create a graph of the average ice melt capacity at each time interval.

$$\overline{IMC}_{xn} = \Sigma IMC_{xn} / n \quad (\text{Equation 3})$$

Where:

X = sample (A, B, C, or D)

n = replicate test number (i.e., n = 1, 2, 3*)

*Note – If more than triplicate testing is required, n will correspond to the number of tests performed.

6.4 Average Ice Melting Capacity 90 (\bar{IMC}_{90})

\bar{IMC}_{90} is the average of the Sample D replicate results from Equation 2 (IMC_{xn}) at 90 minutes, the end of the rocking period.

$$\bar{IMC}_{90} = \Sigma IMC_{Dn} / n \quad (\text{Equation 4})$$

Where:

n = replicate test number (i.e., n = 1, 2, 3*)

*Note – If more than triplicate testing is required, n will correspond to the number of tests performed.

6.5 Initial Melting Velocity (IMV_n), grams ice melted/mL deicer*min

IMV_n measures the rate or velocity at which ice melts during the first 15 minutes and is calculated from sample A results from Equation 2 for each replicate test.

$$IMV_n = IMC_{An} / 15 \text{ min} \quad (\text{Equation 5})$$

Where:

n = replicate test number (i.e., n = 1, 2, 3*)

*Note – If more than triplicate testing is required, n will correspond to the number of tests performed.

6.6 Average Initial Melting Velocity (\bar{IMV}_{avg})

\bar{IMV}_{avg} is the average of the results from Equation 5.

$$\bar{IMV}_{avg} = \Sigma IMV_n / n \quad (\text{Equation 6})$$

Where:

n = replicate test number (i.e., n = 1, 2, 3*)

*Note – If more than triplicate testing is required, n will correspond to the number of tests performed.

7 Reporting

7.1 The Initial Melting Velocity IMV_n (Equation 5). This indicates how fast a deicer product begins working.

7.2 The average ice melting capacity at 90 minutes \bar{IMC}_{90} (Equation 4). This indicates how much ice a deicer will melt 90 minutes after contact.

8 Precision and Bias

8.1 The Single-Operator Coefficient of Variation represents the expected variation of measured ice melting capacity of a sample prepared and tested in triplicate by one operator in a single lab. The Coefficient of Variation is 3.0%

METHODS OF SAMPLING AND TESTING
MT 526-16
MOISTURE ANALYSIS OF CLEAR ROADS CATEGORY 8A, 8B,
AND 8C SOLID SODIUM CHLORIDE
(Modified ASTM E534)

1 Scope

- 1.1 This method is utilized to determine the water insoluble residue of Clear Roads specified salt for product acceptance by the Montana Department of Transportation. This method will serve as the reference method for salt with an insoluble residue of 0.0% – 10.0% by mass.

2 Referenced Documents**ASTM Standards**

E534 Standard Test Methods for Chemical Analysis of Sodium Chloride

Other Standards

Clear Roads Document - Clear Roads Snow and Ice Control Chemical Products, Specifications, and Test Protocols (<https://clearroads.org/wp-content/uploads/12-10-Final-CR-SPECS-wCategory4.pdf>).

3 Apparatus and Reagents

3.1 *Analytical Balance*

3.2 *Desiccator*

3.3 *Oven*

4 Procedure

- 4.1 Weigh 100g of salt to the nearest 0.01g (split or quartered from original sample) into a previously dried and weighed moisture dish or pan. Distribute the salt in the vessel such that it is not more than 1/4 of an inch in depth at any given location.
- 4.2 Dry at 110°C for 2 hours.
- 4.3 Cool to room temperature in a desiccator and weigh.

5 Calculation and Reporting

- 5.1 Calculate the percentage of moisture as follows:

$$\text{moisture, mass \%} = \frac{(I - F)}{I} * 100$$

where:

F = final mass of the dry salt

I = initial mass of the wet salt

- 5.2 Report the insoluble residue to the nearest 0.01%.

6 Validation Data

6.1 Precision and Bias

Moisture %	$\sigma_{(n-1)}$ %	n	95% CL %	Intra Laboratory $\sigma_{(n-1)}$ %	Intra Laboratory n	Intra Laboratory 95% CL %	Inter Laboratory $\sigma_{(n-1)}$ %	Inter Laboratory n	Inter Laboratory 95% CL %
0-5.0%	0.005	29	0.03	0.006	3	0.03	0.006	6	0.04
5.1%-10.0%	0.008	31	0.05	0.008	3	0.06	0.009	6	0.06

METHODS OF SAMPLING AND TESTING
MT 530-16
DETERMINATION OF CHLORIDE IN BRIDGE DECK CONCRETE
BY ION CHROMATOGRAPHY
(Montana Method)

1 Scope

- 1.1 This method describes the procedure used to determine the concentration of acid-soluble chloride in bridge deck concrete via ion chromatography.
- 1.2 This method may involve hazardous materials, operations, and equipment. This method does not purport to address all of the safety concerns associated with its use. It is the responsibility of the user of this procedure to establish appropriate safety and health practices and to determine the applicability of regulatory limitations prior to use.

2 Referenced Documents

ASTM

D1193 Standard Specification for Reagent Water

MT Materials Manual

MT 114 Sampling for Chloride Content of Bridge Deck Concrete

Other

Method Tex-620-J, Determining Chloride and Sulfate Contents in Soil

(http://ftp.dot.state.tx.us/pub/txdot-info/cst/TMS/600-J_series/archives/620-0805.pdf)

3 Terminology

- 3.1 *Chromatography* – the separation and quantitative analysis of ions based on their affinity to the ion exchanger.
- 3.2 *Eluent* – A solution that transports the sample through the system and contributes to the selectivity of the separation in the ion chromatograph.

4 Summary of Test Method

- 4.1 The chloride ion is extracted from concrete samples, put into solution, centrifuged, filtered and injected into the Ion Chromatograph (IC). The sodium carbonate/bicarbonate eluent transports the sample through the column which is operating with a suppressed conductivity method. The ion chromatograph detects chloride ions which interface with the column and are read on the instrument's conductivity detector.

5 Significance and Use

- 5.1 This procedure is used to determine the concentration of the chloride ion in concrete samples collected from bridge decks. The chloride ion concentration is used to evaluate the level of corrosion and determine the maintenance requirement for bridge decks.

6 Apparatus

6.1 *Metrohm Basic Ion Chromatograph Plus 883* equipped with:

6.1.1 Autosampler

6.1.2 Metrosep A Supp 150/4.0 Column

6.1.3 Conductivity Detector

6.1.4 MagIC Net Software

6.2 *Centrifuge*

7 Reagents and Materials

7.1 *Reagent Water* – Purified water that meets ASTM Type II specifications or better (ASTM D1193)

7.2 *Suppressor Regenerant Solution*, 0.1 Molar Sulfuric Acid (H_2SO_4)

7.3 *Suppressor Rinse Solution*, 99.9% MeOH

7.4 *Neutralizing Solution*, 0.5 M Sodium Hydroxide (aqueous)

Add 500mL of reagent water to a 750 or 1000mL glass beaker and slowly add 9.99 g of solid NaOH pellets to the reagent water and mix.

7.5 *Eluent*, 3.2 M Sodium Carbonate, Na_2CO_3 /1.0 M Sodium Bicarbonate, NaHCO_3 (aqueous); (stock eluent solution, A Supp 5 Eluent 100x, ordered from Metrohm). Shelf life of eluent is 2 days.

7.6 *Nitric Acid (HNO_3)*, concentrated Trace Metal Grade, 65-75%

7.7 *Standard Stock Solution*, Dionex Five Anion Standard, chloride concentration of 30 ppm

7.7 *Glassware*: 50 mL beakers, 100mL volumetric flasks for dilution

7.8 *Auto-pipettes*

7.9 *Plastic Syringes*, 30 mL non-sterile

7.10 *Syringe filters* - particle retention of 0.2 μm

7.11 *Dry plastic bottles* that have been stored filled with a dilute HNO_3 acid solution (1 – 5%) prior to use

7.12 *Disposable IC vials*, 11 ml

8 Sampling

8.1 Bridge deck concrete samples are collected in accordance with [MT 114](#) and pulverized in a Bico pulverizer with plates spaced between 1 and 2 mm.

9 Calibration and Standardization

9.1 IC Instrumentation Settings:

- 9.1.1 Flow rate on IC: 0.7 mL/min
- 9.1.2 Sample Loop: 20 μ L
- 9.1.3 Run time: 20 minutes

9.2 Calibration Curve Determination

- 9.2.1 Prepare standards from a five anion standard. The Dionex Five Anion Standard with a chloride concentration of 30 ppm is commonly used.
- 9.2.2 Weigh indicated masses from the 5 anion standard bottle into a dry plastic bottle (See Table 1). Record weights to the thousandth decimal place.
- 9.2.3 Dilute with reagent water for a target total mass of 50 g (\pm 0.001)

Table 1: Standard calibration solutions and masses of components

Concentration, ppm	Mass of 5 anion standard, g	Mass of solution, g
0.5	0.834	50.000
1.0	1.667	50.000
2.0	3.334	50.000
4.0	6.667	50.000
5.0	8.334	50.000
10.0	16.668	50.000

Note 1 - The masses in Table 1 above have been developed for the Dionex Five Anion Standard which has a chloride concentration of 30 ppm, if another standard is used the weights in the table are not applicable

- 9.2.4 Determine concentration of each standard and enter into the IC software.

10 Procedure

10.1 Preparation of Controls

- 10.1.1 For each sequence to be analyzed on the IC, prepare and analyze a quality control (QC) sample. Use a QC sample with a concentration which is mid-range of the calibration curve. For example, chloride standard preparations range from 0.5 ppm to 10 ppm. A QC sample with a target of approximately 3 ppm is sufficient. Using a Portland cement with a qualified standard of 0.127% is an acceptable QC sample. Determine percent recovery per Section 11.5 below. Analysis is considered acceptable with a percent recovery on the quality control sample of \pm 10%.

10.2 Sample Preparation and Analysis

- 10.2.1 Weigh 0.25 g of sample into a 50 – 60 mL beaker using a balance with an accuracy of \pm 0.0001 g. Record the sample weight to be used in final calculation (W_s). Add 1 mL of reagent water to the beaker to liquefy the cement sample.
- 10.2.2 In a fume hood, Add 100 μ L of concentrated HNO₃ to the cement paste and swirl gently to mix well. CO₂ gas liberates from the reaction between the cement constituents and nitric acid. Wait roughly 10 minutes for the extraction to occur.
- 10.2.3 Neutralize the solution by adding approximately 1.5 mL of 0.5 M NaOH (2-4 mL may be needed). Test with litmus paper strips to make sure the solution is neutral.
- 10.2.4 Transfer the neutral solution into a 100 mL volumetric flask (V), rinsing the beaker to transfer the solids from the beaker to the flask. Dilute to the fill line with reagent water.

10.2.5 Pour approximately 10 mL of the solution into a plastic syringe equipped with a 0.2 µm nylon filter tip. Filter the solution into a plastic ion chromatography test tube.

Note 2 – If the turbidity of the sample is such that light cannot pass through it, then centrifuge the sample at 500 rpm for roughly 15 minutes in a plastic nunc tube prior to pouring the sample into the IC vial centrifuge.

10.6 Analyze the sample and the QC sample simultaneously on the IC to determine the chloride concentration. Shelf life of the sample is one week.

11 Calculation or Interpretation of Results

11.1 Dilution Factor

$$DF = \frac{V_f}{V_i}$$

Where:

DF = Dilution factor

V_f = Final volume (diluent and aliquot)

V_i = initial volume

11.1.1 Dilution Factor for Concrete Sample

The dilution factor (DF) for the concrete sample is the volume of the volumetric flask used in Section 10.2.4 (i.e., 100 mL).

11.2 Chloride Concentration in Concrete

$$C_{cl} = \frac{(C_{ic} * DF)}{W_s}$$

Where:

C_{cl} = Concentration of the chloride in the original concrete, ppm

C_{ic} = Concentration of the chloride as determined by the IC, ppm

DF = Dilution factor

W_s = Weight of the sample, g

11.2.1 *Example:* $C_{ic} = 2.78 \text{ mg/L (or ppm)}$
 $DF = 100$
 $W_s = 0.2529 \text{ g}$

$$C_{cl} = (2.78 * 100) / 0.2529 = 1099 \text{ ppm}$$

11.3 Percent Chloride in Concrete

$$\%Cl = \frac{C_{cl}}{10,000}$$

11.3.1 *Example:* $C_{cl} = 1099 \text{ ppm (from above)}$

$$\%Cl = 1099 / 10,000 = 0.1099\%$$

11.4 *Pounds of Chloride per cubic yard of Concrete*

$$P_c = \frac{(C_{cl} * D_c)}{1,000,000}$$

Where:

P_c = Pounds of chloride per cubic yard of concrete

C_{cl} = Concentration of chloride ions in the original concrete sample, ppm

D_c = Density of concrete (4,000 lb/cy)

11.5 *Percent Recovery of Quality Control Sample*

$$\% \text{ Recovery} = [C_{IC(QC)} * DF / W_{QC} / 10,000 / C_{QC}] * 100\%$$

Where:

$C_{IC(QC)}$ = Concentration of the Quality Control Sample as determined by the IC, ppm

C_{QC} = Known value of the quality control sample

DF = Dilution factor

W_{QC} = Weight of the Quality Control Sample, g

11.5.1 *Example:*

$$C_{IC(QC)} = 3.15 \text{ ppm}$$

$$DF = 100$$

$$W_{QC} = 0.2529 \text{ g}$$

$$C_{QC} = 0.127\%$$

$$\% \text{ Recovery} = [3.15 * 100 / 0.2529 / 10,000 / 0.127] * 100 = 98.07\%$$

12 Report

12.1 Enter chloride analysis results in the following location:

<X:\CHEMISTRY\LAB\Bridge Chlorides 20XX.xlsx>

METHODS OF SAMPLING AND TESTING
MT 532-16
DETERMINATION OF SULFATE CONTENT IN SOILS BY ION CHROMATOGRAPHY

1 Scope

- 1.1 This method describes the procedures used to determine water-soluble sulfate in soils through the use of the ion chromatograph (IC).
- 1.2 This method was developed as an alternative to the sulfate analysis in [MT 232](#) and was validated June 2016.
- 1.3 This method may involve hazardous materials, operations, and equipment. This method does not purport to address all of the safety concerns associated with its use. It is the responsibility of the user of this procedure to establish appropriate safety and health practices and to determine the applicability of regulatory limitations prior to use.

2 Referenced Documents**ASTM**

C1580 Standard Test Method for Water-Soluble Sulfate in Soil
D1193 Standard Specification for Reagent Water

MT Materials Manual

MT 232 Soil Corrosion Test

Other

TX DOT, Tex-620-J, Determining Chloride and Sulfate Contents in Soil
(http://ftp.dot.state.tx.us/pub/txdot-info/cst/TMS/600-J_series/archives/620-0805.pdf)
Validation of Sulfate Method on the Ion Chromatograph, MDT, June 2016.

3 Summary of Test Method

- 3.1 Soils are dissolved in water and analyzed on the ion chromatograph. This method is substantially based on ASTM C1580 and the Texas Department of Transportation Method Tex-620-J. The method of analysis can be used for both solid soil and water samples. The samples are dissolved or diluted in water, filtered and injected into the IC instrument. A calibration curve is prepared on the IC using a five anion standard. Sulfate results are obtained in ppm as determined by the IC.

4 Significance and Use

- 4.1 This procedure is used to determine sulfate content in soil samples for pipe corrosion evaluation and soil survey samples.

5 Apparatus

- 5.1 *Metrohm Basic Ion Chromatograph Plus 883* equipped with:
- 5.1.1 Autosampler
- 5.1.2 Metrosep A Supp 150/4.0 Column
- 5.1.3 Conductivity Detector
- 5.1.4 MagIC Net Software

6 Reagents and Materials

- 6.1 *Reagent Water* – Purified water that meets ASTM Type II specifications or better (ASTM D1193)
- 6.2 *Suppressor Regenerant Solution*, 0.1M Sulfuric Acid, H₂SO₄ (aqueous)

- 6.3 *Suppressor Rinse Solution*, 99.9% MeOH
- 6.4 *Eluent*, 3.2 M Sodium Carbonate, Na₂CO₃/1.0 M Sodium Bicarbonate, NaHCO₃ (aqueous); (stock eluent solution, A Supp 5 Eluent 100x, ordered from Metrohm and kept in-house).
- 6.5 *Standard Stock Solution*, Dionex Five Anion Standard, Sulfate concentration of 150 mg/L
- 6.6 *Glassware*: 250 mL beakers and large glass centrifuge tubes
- 6.7 *Class A pipettes*, for secondary dilution
- 6.8 *Plastic Syringes*, 30 mL non-sterile
- 6.9 *0.20 μm nylon filters*, non-sterile

7 Sampling

- 7.1 Samples are prepared in accordance with [MT 232](#). A 3 gram (g) sample is required for analysis.

8 Calibration and Standardization

8.1 IC Instrumentation Settings

- 8.1.1 Flow rate on IC: 0.7 mL/min
- 8.1.2 Sample Loop: 20 μL
- 8.1.3 Run time: 20 minutes

8.2 Calibration Curve Determination

- 8.2.1 Prepare six standards based on the indicated concentrations and masses in Table 1 using the Dionex Five Anion Standard. The values for the sulfate calibration curve range from approximately 2.5 ppm and 50 ppm.
- 8.2.2 Weigh the standard into a plastic bottle. Record weights to the thousandth decimal place.
- 8.2.3 Dilute the standard to a target total mass of 50 (±0.001g) with reagent water. Record the final weight.

Table 1: Standard calibration solutions and masses of components

Concentration, ppm	Mass of 5 anion standard, g	Mass of solution, g
2.5	0.834	50.000
5	1.667	50.000
10	3.334	50.000
20	6.667	50.000
25	8.334	50.000
50	16.668	50.000

Note 1 - The masses in Table 1 above have been developed for the Dionex Five Anion Standard which has a sulfate concentration of 150 ppm, if another standard is used the weights in the table are not applicable

- 8.2.4 Inject the six prepared standards and utilize the instrumentation on the IC to develop a calibration curve.

9 Procedure

9.1 Preparation of Controls

For each sequence to be analyzed on the IC, prepare a Quality Control (QC) sample in the target range of approximately 20 ppm. Use a qualified soil standard with a known concentration of 1630 ppm (± 43.7 ppm) to prepare the control. Determine percent recovery per Section 10.4 below. Analysis is considered acceptable with a percent recovery on the control sample of $\pm 10\%$.

9.2 Sample Preparation and Analysis

9.2.1 Weigh 3 grams of sample from the remaining material used for the conductivity preparation in [MT 232](#) into a 250 ml glass beaker. Record the weight to the thousandth decimal place (W_s).

9.2.2 Add 150 mL of reagent water and mix with a stir bar for an hour.

9.2.3 Pour approximately 20 mL of the liquid extract into a syringe with attached 0.20 μm nylon filter. Filter this extract directly into plastic ion chromatography test tube and cap.

9.2.4 Analyze the sample and the QC sample simultaneously on the IC to determine the sulfate concentrations.

Note 2 – A secondary dilution may be necessary if concentration falls outside of the range determined by the calibration curve.

10 Calculation or Interpretation of Results

10.1 Dilution Factor

$$DF = \frac{V_f}{V_i}$$

Where:

DF = Dilution factor

V_f = Final volume (diluent and aliquot)

V_i = initial volume

10.1.1 Dilution Factor for Secondary Dilution

$$DF = \frac{V_d}{V_p}$$

Where:

DF = Dilution factor

V_d = Volume of the flask used for the dilution, mL

V_p = Volume of the pipette used to make the dilution, mL

10.2 Concentration of sulfate ion in the original soil sample

$$C_{SO_4} = (C_{IC} * DF) / W_s$$

Where:

C_{SO_4} = Concentration of the sulfate in the original soil sample, ppm

C_{IC} = concentration of sulfate ion in the sample run through the IC, ppm

DF = Dilution factor

W_s = Weight of the sample, g

10.2.1 Example: $C_{IC} = 2.948$ mg/L (or ppm)
 $DF = 150$
 $W_s = 3.0041$ g

$$C_{SO_4} = (2.948 * 150) / 3.0041 = 147.2 \text{ ppm}$$

10.3 Percent Sulfate in Soil

$$\% SO_4 = C_{SO_4} / 10,000$$

10.4 Percent Recovery Quality Control Sample

$$\% \text{ Recovery} = [C_{IC(QC)} * DF / W_{QC} / 10,000 / C_{QC}] * 100\%$$

Where:

$C_{IC(QC)}$ = Concentration of the soil standard sample as determined by the IC, ppm

C_{QC} = Known value of the soil standard (soil standard typically is 1630 ppm SO_4), ppm

DF = Dilution factor

W_{QC} = Weight of the quality control sample, g

10.4.1 Example: $C_{IC(QC)} = 31.96$ ppm
 $DF = 50$
 $W_{QC} = 1.004$ g
 $C_{QC} = 1630$ ppm

$$\% \text{ Recovery} = [31.96 * 50 / 1.004 / 1630] * 100 = 98.07\%$$

11 Report

The concentration of the sulfate will be recorded in the soil corrosion spreadsheets and the Sitemanager data base as percent sulfate.

METHODS OF SAMPLING AND TESTING
MT 533-16
METHOD OF TEST FOR CHEMICAL ANALYSIS OF FLY ASH AND POZZOLANS
(Montana Method)

1 Scope

- 1.1 This test method describes the procedures used to determine the concentration of elemental oxides and sulfur trioxide of fly ash and pozzolans for use in Portland Cement. Three test procedures are described in this document:
- 1.1.1 Spectroscopic Determination of Elemental Oxides in Fly Ash and Pozzolans
- 1.1.2 Spectroscopic Determination of Sulfur Trioxide in Fly Ash and Pozzolans
- 1.1.3 Spectroscopic Determination of Silicon Dioxide in Fly Ash and Pozzolans
- 1.2 This test method also denotes reference test methods:
- 1.2.2 Moisture of Fly Ash and Pozzolans – ASTM C311 Sections 11 and 12
- 1.2.1 Loss on Ignition of Fly Ash and Pozzolans – ASTM C311 Sections 13 and 14
- 1.3 This standard does not purport to address all of the safety concerns, if any, associated with its use. It is the responsibility of the user of this standard to establish appropriate safety and health practices and determine the applicability of regulatory limitations prior to use.

2 Referenced Documents**ASTM**

- C114 Standard Test Methods for Chemical Analysis of Hydraulic Cement
- C150 Standard Specifications for Portland Cement
- C311 Standard Test Methods for Sampling and Testing Fly Ash or Natural Pozzolans for Use in Portland-Cement Concrete
- D1193 Standard Specification for Reagent Water
- E29 Practice for Using Significant Digits in Test Data to Determine Conformance with Specifications
- E542 Practice for Calibration of Laboratory Volumetric Apparatus
- E694 Standard Specification for Laboratory Glass Volumetric Apparatus
- STP 985 Rapid Methods for Chemical Analysis of Hydraulic Cement

FHWA

- FHWA-RD-72-41 A New Method for Rapid Cement Analysis (Atomic Absorption Spectrophotometry)

MT Materials Manual

- MT 108 Sampling and Certification of Portland Cement
- MT 607 Procedure for Reducing Field Samples to Testing Size

3 Summary of Test Method3.1 *Spectroscopic Determination of Elemental Oxides in Fly Ash and Pozzolans Summary of Test Method*

In this test method fly ash or pozzolans are dissolved in a combination of acids via a digestion in Teflon vessels secured in a microwave digestion system. The solution is diluted and analyzed by means of an Inductively Coupled Plasma – Optical Emission Spectrophotometer (ICP-OES). The following analytes are quantified as oxides: calcium, magnesium, iron, aluminum, potassium, and sodium.

3.2 *Spectroscopic Determination of Sulfur Trioxide in Fly Ash and Pozzolan Summary of Test Method*
This test method is substantially based on the publications ASTM STP 985, FHWA-RD-72-41 and the reference test method of ASTM C114. In this method, sulfur is extracted from fly ash or pozzolans using nitric acid and hydrogen peroxide and then quantified via ICP-OES analysis. This procedure is valid for the analysis and reporting of sulfur trioxide.

3.3 *Spectroscopic Determination of Silicon Dioxide in Fly Ash and Pozzolans Summary of Test Method*
This test method is substantially based on the publications ASTM STP 985 and FHWA-RD-72-41. In this method, the fly ash or pozzolan is solubilized by fusion with a mixed lithium metaborate and lithium tetraborate powder. The molten glass bead is dissolved in a weak nitric acid solution and analyzed by ICP-OES.

4 Significance and Use

4.1 This procedure is primarily used to provide quality assurance for the fly ash and pozzolan samples submitted by suppliers for inclusion on the MDT Qualified Product List as well as provide analytical information for design applications using fly ash or pozzolans.

5 Apparatus

5.1 *Inductively Coupled Plasma-Optical Emission Spectrophotometer (ICP-OES)*

5.2 *Microwave digestion system* – Capable of heating samples to 200°C and maintaining that temperature for at least 30 minutes.

5.3 *Labware* – Glassware, Teflon, and Plasticware containers that have been properly cleaned and stored filled with dilute nitric acid solution (1 – 5%) for at least 2 days.

5.4 *Analytical Balances* – For the initial weighing of samples and standards, a balance with a precision of 0.0001 g should be used. For weighing material over 210 g, a balance with a precision of 0.01 g should be used.

5.5 *Muffle Furnace* – Capable of maintaining a temperature of 950°C ± 25° verified by clay pyrometric cones yearly.

6 Reagents and Materials

6.1 *Trace metal grade (TMG) Hydrochloric acid (HCl)*, concentrated (32-38%)

6.2 *TMG Nitric acid (HNO₃)*, concentrated (65-70%)

6.3 *Fluoroboric acid (HBF₄)*, concentrated (46-52%)

6.4 *Hydrogen Peroxide (H₂O₂)*, concentrated (30-38%)

6.5 *Reagent Water* – Purified water that meets ASTM Type II specifications or better (ASTM D1193)

6.6 *Filter paper* – Particle retention of 20 – 25 µm and a medium flowrate.

6.7 *Ultra-pure Grade Lithium Borate Flux* – composed of 66 ±10% Lithium tetraborate (Li₂B₄O₇), 33 ±10% lithium metaborate (LiBO₂) and 1 ±1% lithium bromide (LiBr)

7 Sampling

7.1 Fly ash or pozzolan samples are to be collected in accordance with MT 108 and split in accordance with MT 607. A 50 mL sample should be provided to the Chemistry Lab for analysis.

SPECTROSCOPIC DETERMINATION OF ELEMENTAL OXIDES IN FLY ASH AND POZZOLANS**8 Calibration and Standardization**

Follow manufacturer's specifications for calibrating and standardizing the ICP-OES. Appendix A provides calibrating and standardizing specifications for a Varian Axial ICP-OES for the determination of elemental oxides.

9 Procedure

- 9.1 Weigh $0.1000 \text{ g} \pm 0.0005 \text{ g}$ of fly ash or pozzolan onto tared waxed paper or a small weighing boat. Record the mass.
- 9.2 Transfer the sample to a Teflon insert for microwave digestion. Reweigh the waxed paper or weighing boat and note the residual mass from the sample. Record the residual mass and calculate the mass transferred to the Teflon insert.
- 9.3 In a ventilation hood, add 10 mL TMG Hydrochloric acid, 4 mL TMG Nitric acid, and 4 mL Fluoroboric acid to the Teflon insert using autopipets with disposable tips. Place the Teflon insert in the carousel.
- 9.4 Once all samples have been prepared, place the carousel in the microwave digestion system. Begin the digestion process (see Appendix A for MDT digestion process). After completion of the digestion process, allow the carousel to cool before removing. The carousel may be left overnight to cool.
- 9.5 Remove a digestion vessel and open it. Rinse the sample into a clean Teflon beaker. Tare a dry 500 mL plastic volumetric flask. Rinse the solution from the beaker into the plastic volumetric flask. Place the plastic volumetric flask on the balance and add reagent water to a mass of $500.00 \text{ g} \pm 0.05 \text{ g}$. Cap the plastic volumetric flask and invert it several times to homogenize the solution.
- 9.6 Pour some of the solution into a plastic sample bottle for a stock solution. Label the container with the sample number, date, analyst initials, and as fly ash or pozzolan stock solution.
- 9.7 Dilute the stock solution by dispensing $1.50 \text{ g} \pm 0.03 \text{ g}$ of the solution into a 15 mL centrifuge tube and add reagent water until the mass is $15.00 \text{ g} \pm 0.03 \text{ g}$. Label the centrifuge tube with the sample number, date, analyst initials, and as fly ash or pozzolan dilute solution.
- 9.8 Repeat Sections 9.5 to 9.7 for all samples.
- 9.9 Analyze the dilute solutions on an ICP-OES.

SPECTROSCOPIC DETERMINATION OF SULFUR TRIOXIDE IN FLY ASH AND POZZOLANS**10 Calibration and Standardization**

Follow manufacturer's specifications for calibrating and standardizing the ICP-OES. Appendix B provides calibrating and standardizing specifications for a Agilent Radial ICP-OES for the determination of sulfur trioxide.

11 Procedure

11.1 Weigh 0.5000 g \pm 0.0005 g fly ash or pozzolan directly into a dry 250 mL beaker.

Note – If a thick walled beaker is used that is too heavy for the balance, the cement can be weighed on waxed paper or a small weighing boat and transferred. Reweigh the waxed paper or weighing to account for any cement that may have stuck to it.

11.2 Add 5.0 mL of hydrogen peroxide using an autopipet to each beaker.

11.3 Bring the solution to the 100 mL mark on the beaker with reagent water.

11.4 Add 10.0 mL of nitric acid to the beaker using an autopipet.

11.5 Add a Teflon stir bar and place on a stir plate to agitate for a minimum of 60 minutes. A good stir rate is about two revolutions per second.

11.6 Quantitatively filter into a 500 mL glass volumetric flask and rinse many times with reagent water.

11.7 Bring to volume with reagent water.

11.8 Transfer the solution to a 500 mL HDPE bottle. Label with the sample number, the date, analyst initials, and analyte of interest.

11.9 Once all the samples are prepared, analyze the solutions using the ICP-OES.

SPECTROSCOPIC DETERMINATION OF SILICON DIOXIDE IN FLY ASH AND POZZOLANS**12 Calibration and Standardization**

Follow manufacturer's specifications for calibrating and standardizing the ICP-OES. Appendix C provides calibrating and standardizing specifications for a ICP-OES for the determination of silicon dioxide.

13 Procedure

- 13.1 Weigh 0.8000 g \pm 0.005 g of lithium borate flux into a graphite crucible.
- 13.2 Tare the flux and crucible and add 0.1000 g \pm 0.0005 g fly ash or pozzolan on top of the flux.
- 13.3 Fuse the graphite crucible(s) containing the samples in the muffle furnace at 950°C for 5 minutes. Do not fuse more than two crucibles at a time. Swirl the crucible to consolidate all residual sample that may be sticking to the sides of the crucible. Continue fusing for an additional 15 minutes at 950°C.
- 13.4 Prior to or during the fusion process, prepare an adequate number of Teflon beakers (at least 200 mL) by rinsing them copiously with reagent water. Add 50 mL of 1 + 24 nitric acid to the beakers. Place a Teflon stir bar in each beaker and cover each with a watch glass. Place the beakers on a stir plate near the furnace and stir at a rate of about two revolutions per second.
- 13.5 At the completion of the fusion process, quickly transfer the fusion bead from the graphite crucible to one of the prepared Teflon beakers. Inspect the graphite crucible for any trace of sample or fusion material; discard the sample if either are present. Replace the watch glass on the beaker and stir for a minimum of 30 minutes or until all material is dissolved. More acid may be needed to completely dissolve the fusion bead; add the same amount of acid to each sample in order to maintain the same acid content. If additional acid results in material coming out of solution, the sample is not suitable for analysis; discard the sample.
- 13.6 Once all the material has dissolved, prepare the stock solution by transferring the solution to a 500 mL class A volumetric flask. Bring to volume with reagent water and add nitric acid such that the concentration of nitric acid will be 15 + 485. Cover the flask with Parafilm and invert a minimum of eight times to thoroughly mix.
- 13.7 Transfer the stock solution to a plastic sample bottle; discard any excess solution. Label the container with the sample number, fly ash or pozzolan, Si analysis, stock solution, date, and analyst initials.
- 13.8 Once all the samples are prepared, analyze the stock solutions on an ICP-OES.

14 Report

14.1 Data Reporting and Retention for fly ash or pozzolans will be reported as shown below:

Analyte	Report As	Significance
Ca	CaO	XX.XX
Al	Al ₂ O ₃	X.XX
Fe	Fe ₂ O ₃	X.XX
Mg	MgO	X.XX
Si	SiO ₂	XX.XX
K	K ₂ O	X.XXX
Na	Na ₂ O	0.XXX
S	SO ₃	X.XX
LOI	LOI	X.XX
Moisture	Moisture	X.XX

15 Validation

15.1 For validation data and quality control information consult ASTM C114 and ensure all instruments meet its conditions.

APPENDIX A
SPECTROSCOPIC DETERMINATION OF ELEMENTAL OXIDES IN FLY ASH OR POZZOLANS

Varian Axial ICP-OES configuration parametersEquipment Configuration

Nebulizer: Sea Spray
Spray chamber: cyclonic
Sample pump tubing: White/White
Waste pump tubing: Blue/Blue
Rinse solution: 3% Nitric acid
Torch: High solids with sheath gas
Sheath gas: Argon at 10mL/min
Power: 1.20 kW
Plasma flow: 15.0 L/min
Auxiliary flow: 1.50 L/min
Nebulizer flow: 0.75 L/min
Replicate read time: 6.00s
Instrument stabilization delay: 15s
Sample uptake delay: 30s
Pump rate: 15 rpm
Rinse time: 120s
Fast pump: yes
Replicates: 5

Line Selection for Standards, Samples, and Blanks: Select the best line(s) and average for each element.

Al: 396.152, 394.401, 309.271, and 257.509.

Ca: 393.366, 370.602, 318.127, 317.933, 315.887, 219.779, and 210.324.

Fe: 273.358, 261.187, 260.709, 259.940, and 238.204.

Mg: 285.213, 280.270, 279.553, and 202.582.

K: 766.491 and 769.897.

Na: 589.592 and 588.995.

Calibration Varian Axial ICP-OES

Type: Linear for all elements.

Linear-Maximum percent error of 10% and Confidence limit of 0.99%.

Calibration Standard Selection: Pick NIST or CCRL pozzolan standards that provide a range covering what would likely be expected of the samples being analyzed. Usually a minimum of four should be selected. If any samples fall outside the range of the selected standards more should be selected to expand the range.

Milestone Ethos EZ microwave digestion system

Digestion program used: portcement.mpr

Heat and time: Heat to 200°C and hold temperature during a 30 minute interval. Followed by a 10 minute cooling period

Rotor: SK-10

APPENDIX B
SPECTROSCOPIC DETERMINATION OF SULFUR TRIOXIDE IN FLY ASH OR POZZOLANS

Agilent Radial ICP-OES configuration parametersEquipment Configuration

Nebulizer: OneNeb
Spray chamber: cyclonic
Sample pump tubing: White/White
Waste pump tubing: Blue/Blue
Rinse solution: 3% Nitric acid
Torch: High solids
Power: 1.00 kW
Plasma flow: 15.00 L/min
Auxiliary flow: 1.50 L/min
Nebulizer flow: 0.75 L/min
Viewing height: 10 mm
Replicate read time: 10.00 s
Instrument stabilization delay: 15s
Sample uptake delay: 30s
Pump rate: 15rpm
Rinse time: 10s
Fast pump: yes
Replicates: 3

Line Selection for Standards, Samples, and Blanks: Select the best line(s) and average for each element.
S : 180.669, 181.972

Calibration Agilent Radial ICP-OES

Type: Linear for all elements.

Linear-Maximum percent error of 10% and Confidence limit of 0.99%.

Calibration Standard Selection: Pick NIST or CCRL pozzolan standards that provide a range covering what would likely be expected of the samples being analyzed. Usually a minimum of four should be selected. If any samples fall outside the range of the selected standards more should be selected to expand the range.

APPENDIX C
SPECTROSCOPIC DETERMINATION OF SILICON DIOXIDE IN FLY ASH OR POZZOLANS

Agilent Radial ICP-OES configuration parametersEquipment Configuration

Nebulizer: OneNeb
Spray chamber: cyclonic
Sample pump tubing: White/White
Waste pump tubing: Blue/Blue
Rinse solution: 3% Nitric acid
Torch: High solids
Power: 1.10 kW
Plasma flow: 15.00 L/min
Auxiliary flow: 1.50 L/min
Nebulizer flow: 0.75 L/min
Viewing height: 10 mm
Replicate read time: 10.00 s
Instrument stabilization delay: 15s
Sample uptake delay: 45s
Pump rate: 15rpm
Rinse time: 10s
Fast pump: yes
Replicates: 3

Line Selection for Standards, Samples, and Blanks: Select the best line(s) and average for each element.
Si : 212.412

Calibration Agilent Radial ICP-OES

Type: Linear for all elements.

Linear-Maximum percent error of 10% and Confidence limit of 0.99%.

Calibration Standard Selection: Pick NIST or CCRL pozzolan standards that provide a range covering what would likely be expected of the samples being analyzed. Usually a minimum of four should be selected. If any samples fall outside the range of the selected standards more should be selected to expand the range.

METHODS OF SAMPLING AND TESTING
MT 534-16
CHEMICAL ANALYSIS OF PORTLAND CEMENT
(Montana Method)

1 Scope

- 1.1 This test method describes the procedures used to determine the concentration of elemental oxides and sulfur trioxide of Portland cement. Two test procedures are described in this document:
- 1.1.1 Spectroscopic Determination of Elemental Oxides in Portland Cement
- 1.1.2 Spectroscopic Determination of Sulfur Trioxide in Portland Cement
- 1.2 This test method also denotes reference test methods:
- 1.2.1 Loss on Ignition of Portland Cement – ASTM C114, Section 18
- 1.2.2 Insoluble Residue of Portland Cement – ASTM C114, Section 7
- 1.2.3 Carbon Dioxide Determination in Portland Cement – ASTM C114, Section 24
- 1.2.4 Sulfide Determination in Portland Cement – ASTM C114, Section 17
- 1.2.5 Halogen Determination in Portland Cement – No current validated method
- 1.3 This standard does not purport to address all of the safety concerns, if any, associated with its use. It is the responsibility of the user of this standard to establish appropriate safety and health practices and determine the applicability of regulatory limitations prior to use.

2 Referenced Documents**ASTM**

- C114 Standard Test Methods for Chemical Analysis of Hydraulic Cement
 C150 Standard Specifications for Portland Cement
 D1193 Standard Specification for Reagent Water
 E29 Practice for Using Significant Digits in Test Data to Determine Conformance with Specifications
 E542 Practice for Calibration of Laboratory Volumetric Apparatus
 E694 Standard Specification for Laboratory Glass Volumetric Apparatus
 STP 985 Rapid Methods for Chemical Analysis of Hydraulic Cement

FHWA

- FHWA-RD-72-41 A New Method for Rapid Cement Analysis (Atomic Absorption Spectrophotometry)

MT Materials Manual

- MT 108 Sampling and Certification of Portland Cement
 MT 607 Procedure for Reducing Field Samples to Testing Size

3 Summary of Test Method

- 3.1 *Spectroscopic Determination of Elemental Oxides in Portland Cement Summary of Test Method*
 In this test method, Portland cement is dissolved in a combination of acids via a microwave digestion system. The solution is then diluted and analyzed by an Inductively Coupled Plasma – Optical Emission Spectrophotometer (ICP-OES). The following analytes are quantified as oxides: calcium, magnesium, silicon, iron, aluminum, potassium, titanium, sodium, manganese, zinc, chromium, and phosphorus.

- 3.2 *Spectroscopic Determination of Sulfur Trioxide in Portland Cement Summary of Test Method*
This test method is substantially based on the publications STP 985, FHWA-RD-72-41, and ASTM C114. In this method, sulfur is extracted from Portland cement using nitric acid and hydrogen peroxide and then quantified via ICP-OES analysis. This procedure is valid for the analysis and reporting of sulfur trioxide.

4 Significance and Use

- 4.1 This procedure is primarily used to provide quality assurance for the Portland cement submittals for suppliers on the MDT Qualified Product List as well as provide analytical information for design applications using Portland cement.

5 Apparatus

- 5.1 *Inductively Coupled Plasma-Optical Emission Spectrophotometer (ICP-OES)*
- 5.2 *Microwave digestion system* – Capable of heating samples to 200°C and maintaining that temperature for at least 30 minutes.
- 5.3 *Labware* – Glassware, Teflon, and Plasticware containers that have been properly cleaned and stored filled with dilute nitric acid solution (1 – 5%) for at least 2 days.
- 5.4 *Analytical Balances* – For the initial weighing of samples and standards, a balance with a precision of 0.0001 g should be used. For weighing material over 210 g, a balance with a precision of 0.01 g should be used.

6 Reagents and Materials

- 6.1 *Trace metal grade (TMG) hydrochloric acid (HCl)* – Any commercially available brand at a concentration of 32-38%.
- 6.2 *TMG nitric acid (HNO₃)* – Any commercially available brand at a concentration of 65-70%.
- 6.3 *Fluoroboric acid (HBF₄)* – Any commercially available brand at a concentration of 46-54%.
- 6.4 *Hydrogen Peroxide (H₂O₂)* – Any commercially available brand at a concentration of 30-38%.
- 6.5 *Reagent Water* – Purified water that meets ASTM Type II specifications or better (ASTM D1193)
- 6.6 *Filter paper* – Particle retention of 20 – 25 µm and a medium flowrate.

7 Sampling

- 7.1 Cement samples are to be collected in accordance with MT 108 and split in accordance with MT 607. A 50 mL sample should be provided to the Chemistry Lab for analysis.

SPECTROSCOPIC DETERMINATION OF ELEMENTAL OXIDES IN PORTLAND CEMENT**8 Calibration and Standardization**

Follow manufacturer's specifications for calibrating and standardizing the ICP-OES. Appendix A provides calibrating and standardizing specifications for an Agilent Radial ICP-OES for the determination of elemental oxides.

9 Procedure

- 9.1 Weigh $0.2000 \text{ g} \pm 0.0005 \text{ g}$ Portland cement onto tared waxed paper or small weighing boat. Record the mass.
- 9.2 Transfer the sample to a Teflon insert for microwave digestion. Reweigh the waxed paper or weighing boat and note the residual mass from the sample. Record the residual mass and calculate the mass transferred to the Teflon insert.
- 9.3 In a ventilation hood, add 10 mL TMG Hydrochloric acid, 4 mL TMG Nitric acid, and 4 mL Fluoroboric acid to the Teflon insert using autopipets with disposable tips. Place the Teflon insert in the carousel.
- 9.4 Assemble all components required for proper microwave digestion according to the manufacturer's instructions and then run the digestion. MDT's parameters for a Milestone Ethos EZ microwave digestion system are in Appendix A.
- 9.5 After completion of the digestion process, allow the carousel to cool before removing. The carousel may be left overnight to cool.
- 9.6 Remove the digestion vessel and open it. Rinse the sample into a clean Teflon beaker or other suitable cleaned container. Tare an appropriate storage container on the analytical balance. Rinse the sample into the storage container. Place the storage container back onto the analytical balance and dilute with reagent water until a mass of $100.00 \text{ g} \pm 0.05$. Record the mass to nearest 0.01 g.
- 9.9 Label the sample bottle with the sample number, date, analyst initials, and as Portland cement stock solution.
- 9.10 Using the stock solution, prepare a dilute solution for the analysis of silicon and calcium oxides. In a centrifuge tube, dilute the stock solution at a ratio of 1:5 with reagent water. Label the centrifuge tube with the sample number, date, analyst initials, and as Portland cement dilute solution.
- 9.11 Once all the samples have been prepared, analyze the dilute and stock solutions on an ICP-OES.

SPECTROSCOPIC DETERMINATION OF SULFUR TRIOXIDE IN PORTLAND CEMENT**10 Calibration and Standardization**

Follow manufacturer's specifications for calibrating and standardizing the ICP-OES. Appendix B provides calibrating and standardizing specifications for an Agilent Radial ICP-OES for the determination of sulfur trioxide.

11 Procedure

11.1 Weigh 0.5000 g \pm 0.0005 g Portland cement directly into a dry 250 mL beaker.

Note – If a thick walled beaker is used that is too heavy for the balance, the cement can be weighed on waxed paper or a small weighing boat and transferred. Reweigh the waxed paper or weighing to account for any cement that may have stuck to it.

11.2 Add 5.0 mL of hydrogen peroxide using an autopipet to the beaker.

11.3 Bring the solution to the 100 mL mark on the beaker with reagent water.

11.4 Add 10.0 mL of nitric acid to the beaker using an autopipet.

11.5 Add a Teflon stir bar and place on a stir plate to agitate for a minimum of 60 minutes. A good stir rate is about two revolutions a second.

11.6 Quantitatively filter the sample into a 500 mL glass volumetric flask rinsing many times with reagent water.

11.7 Bring to volume with reagent water.

11.8 Transfer the solution to a 500 mL HDPE bottle. Label with the sample number, the date, analyst initials, and analyte of interest.

11.9 Once all the samples are prepared, analyze the solutions using the ICP-OES.

12 Calculation or Interpretation of Results

12.1 Portland Cement Potential Phase Composition Calculations

12.1.1 Refer to ASTM C150 Annex A1.

12.2 Portland Cement Limestone Content Calculation

12.2.1 Refer to ASTM C150 Annex A2.

12.3 Equivalent Alkalis Calculation for Portland Cement

12.3.1 Refer to ASTM C150 Section 4 Table 2.

13 Report

13.1 Data Reporting for Portland Cement will be reported as shown below:

Analyte	Reported As	Significance
Ca	CaO	XX.XX
Al	Al ₂ O ₃	X.XX
Fe	Fe ₂ O ₃	X.XX
Mg	MgO	X.XX
Si	SiO ₂	XX.XX
Ti	TiO ₂	0.XX
Cr	Cr ₂ O ₃	0.0XX
K	K ₂ O	X.XXX
Mn	Mn ₂ O ₃	0.XXX
Na	Na ₂ O	0.XXX
P	P ₂ O ₅	0.XXX
Zn	ZnO	0.XXX
S	SO ₃	X.XX
S-	S-	X.XX
LOI	LOI	X.XX
ISR	ISR	0.XX
CO ₂	CO ₂	X.XX
Lime Content	Lime Content	X.X
C ₃ S	C ₃ S	XX.X
C ₂ S	C ₂ S	XX.X
C ₃ A	C ₃ A	X.X
C ₄ AF	C ₄ AF	XX.X
Alkalinity	Alkalinity	X.XX
Cl-	Cl-	0.0XX
F-	F-	0.XX

14 Validation

14.1 For validation data quality control information consult ASTM C114 and ensure all instruments meet its conditions.

APPENDIX A
SPECTROSCOPIC DETERMINATION OF ELEMENTAL OXIDES IN PORTLAND CEMENT

Milestone Ethos EZ microwave digestion system

Digestion program used: portcement.mpr

Heat and time: Heat to 200°C and hold temperature during a 30 minute interval. Followed by a 10 minute cooling period

Rotor: SK-10

Agilent Radial ICP-OES configuration parameters*Equipment Configuration for Ca and Si*

- a. Nebulizer: One Neb
- b. Spray chamber: cyclonic
- c. Sample pump tubing: Gray/Gray
- d. Waste pump tubing: Blue/Blue
- e. Rinse solution: 5% Nitric acid
- f. Torch: High solids
- g. Power: 1.20 kW
- h. Plasma flow: 15.00 L/min
- i. Auxiliary flow: 1.50 L/min
- j. Nebulizer flow: 0.60 L/min
- k. Viewing height: 10 mm
- l. Replicate read time: 1.00 s
- m. Instrument stabilization delay: 15 s
- n. Sample uptake delay: 30 s
- o. Pump rate: 15 rpm
- p. Rinse time: 10 s
- q. Fast pump: yes
- r. Replicates: 8

Equipment Configuration for all other analytes

- a. Nebulizer: One Neb
- b. Spray chamber: cyclonic
- c. Sample pump tubing: White/White
- d. Waste pump tubing: Blue/Blue
- e. Rinse solution: 5% Nitric acid
- f. Torch: High solids
- g. Power: 1.15 kW
- h. Plasma flow: 15.00 L/min
- i. Auxiliary flow: 1.50 L/min
- j. Nebulizer flow: 0.75 L/min
- k. Viewing height: 8 mm
- l. Replicate read time: 1.00 s
- m. Instrument stabilization delay: 15 s
- n. Sample uptake delay: 45 s
- o. Pump rate: 15 rpm
- p. Rinse time: 40 s
- q. Fast pump: yes
- r. Replicates: 5

Line Selection for Standards, Samples, and Blanks: Select the best line(s) and average for each element.

- a. Ca : 210.324, 219.779, 315.887, 317.933, 318.127, 370.602, 393.366
- b. Al: 309.271
- c. Fe: 261.187
- d. Mg: 280.270
- e. Si: 185.005, 185.185, 250.690, 251.611, 251.920, 252.411, 252.851, 288.158
- f. Ti: 334.941
- g. Cr: 267.716
- h. K: 766.491
- i. Mn: 257.610
- j. Na: 589.592
- k. P: 213.618
- l. Zn: 213.857

Calibration Agilent Radial ICP-OES

- a. Type: Linear for all elements.
- b. Linear-Maximum percent error of 10% and Confidence limit of 0.99%.
- c. Calibration Standard Selection: Pick NIST or CCRL Portland cement standards that provide a range covering what would likely be expected of the samples being analyzed. Usually a minimum of four should be selected. If any samples fall outside the range of the selected standards more should be selected to expand the range.

APPENDIX B
SPECTROSCOPIC DETERMINATION OF SULFUR TRIOXIDE IN PORTLAND CEMENT

Agilent Radial ICP-OES configuration parameters*Equipment Configuration*

- a. Nebulizer: OneNeb
- b. Spray chamber: cyclonic
- c. Sample pump tubing: White/White
- d. Waste pump tubing: Blue/Blue
- e. Rinse solution: 5% Nitric acid
- f. Torch: High solids
- g. Power: 1.45 kW
- h. Plasma flow: 15.00 L/min
- i. Auxiliary flow: 1.50 L/min
- j. Nebulizer flow: 0.55 L/min
- k. Viewing height: 6 mm
- l. Replicate read time: 3.00 s
- m. Instrument stabilization delay: 15 s
- n. Sample uptake delay: 30 s
- o. Pump rate: 15 rpm
- p. Rinse time: 10 s
- q. Fast pump: yes
- r. Replicates: 3

Line Selection for Standards, Samples, and Blanks: Select the best line(s) and average for each element

- a. S : 180.669, 181.972

Calibration Agilent Radial ICP-OES

- a. Type: Linear for all elements.
- b. Linear-Maximum percent error of 10% and Confidence limit of 0.99%.
- c. Calibration Standard Selection: Pick NIST or CCRL Portland cement standards that provide a range covering what would likely be expected of the samples being analyzed. Usually a minimum of four should be selected. If any samples fall outside the range of the selected standards more should be selected to expand the range.

**METHODS OF SAMPLING AND TESTING
MT 535-16
BRIDGE DECK CRACK SEALANT IR TEST**

THIS PROCEDURE IS IN DEVELOPMENT

METHODS OF SAMPLING AND TESTING
MT 536-16
CHEMICAL ANALYSIS OF SILICA FUME
(Montana Method)

1 Scope

- 1.1 This method describes the procedures to be used for determining chemical analytes in silica fume as recommended by AASHTO M 307 Standard Specification for Silica Fume Used in Cementitious Mixtures.
- 1.2 Spectroscopic Determination of Silicon Dioxide in Silica Fume – MT 533 Chemical Analysis of Fly Ash and Pozzolans
- 1.3 Moisture Content of Silica Fume – ASTM C311 sections 11 and 12
- 1.4 Loss on Ignition (LOI) of Silica Fume – ASTM C311 sections 13 and 14
- 1.5 This standard does not purport to address all of the safety concerns, if any, associated with its use. It is the responsibility of the user of this standard to establish appropriate safety and health practices and determine the applicability of regulatory limitations prior to use.

2 Referenced Documents

ASTM

- C114 Standard Test Methods for Chemical Analysis of Hydraulic Cement
- C311 Standard Test Methods for Sampling and Testing Fly Ash or Natural Pozzolans for Use in Portland-Cement Concrete

AASHTO

M 307 Standard Specification for Silica Fume Used in Cementitious Mixtures

MT Materials Manual

- MT 108 Sampling and Certification of Portland Cement
- MT 533 Chemical Analysis of Fly Ash and Pozzolans
- MT 607 Procedure for Reducing Field Samples to Testing Size

3 Significance and Use

- 3.1 This procedure is primarily used to provide quality assurance for the silica fume submittals for suppliers on the MDT Qualified Product List as well as provide analytical information for design applications using silica fume.

4 Report

- 4.1 Data Reporting and Retention for Silica Fume will be reported as shown below:

Analyte	Report As	Significance
Si	SiO ₂	XX.XX
Moisture	Moisture	X.XX
LOI	LOI	X.XX

5 Validation

- 5.1 For validation data and quality control information consult ASTM C114 and ensure all instruments meet its conditions.

METHODS OF SAMPLING AND TESTING
MT 537-16
CHEMICAL ANALYSIS OF GROUND GRANULATED BLAST-FURNACE SLAG
(Montana Method)

1 Scope

- 1.1 This method describes the procedures to be used for determining chemical analytes of ground granulated blast-furnace slag (GGBFS) as recommended by AASHTO M 302 Slag Cement for Use in Concrete Mortars.
- 1.1.1 This method includes the procedures for the determination of chloride by Ion Chromatography (IC) and the following reference methods.
- 1.2 This test method also denotes reference test methods:
- 1.2.1 Spectroscopic Determination of Sulfur Trioxide – MT 533 Chemical Analysis of Fly Ash and Pozzolans
- 1.2.2 Sulfide Determination – Reference method in ASTM C114 Section 17.2.
- 1.3 This standard does not purport to address all of the safety concerns, if any, associated with its use. It is the responsibility of the user of this standard to establish appropriate safety and health practices and determine the applicability of regulatory limitations prior to use.

2 Referenced Documents**ASTM**

C114 Standard Test Methods for Chemical Analysis of Hydraulic Cement
D1193 Standard Specification for Reagent Water

AASHTO

M 302 Slag Cement for Use in Concrete Mortars

MT Materials Manual

MT 108 Sampling and Certification of Portland Cement
MT 533 Chemical Analysis of Fly Ash and Pozzolans
MT 607 Procedure for Reducing Field Samples to Testing Size

3 Summary of Test Method

- 3.1 Chloride ions are extracted from GGBFS with nitric acid. The resulting sample solutions are analyzed on an Ion Chromatograph.

4 Significance and Use

- 4.1 This procedure is primarily used to provide quality assurance for the GGBFS submittals by suppliers for inclusion on the MDT Qualified Product List as well as provide analytical information for design applications using GGBFS.

5 Apparatus

- 5.1 *Ion Chromatograph (IC)*
- 5.2 *Analytical Balance* – A balance with a precision of 0.0001 g should be used.

6 Reagents and Materials

- 6.1 *Trace metal grade (TMG) Nitric acid (HNO₃)*, concentrated (65-70%)
- 6.2 *Sodium Hydroxide (NaOH)*, concentration of 0.7 Molar
- 6.2 *Reagent Water* – Purified water that meets ASTM Type II specifications or better (ASTM D1193)
- 6.3 *Syringe filters* - particle retention of 0.2 μm
- 6.4 *Litmus paper* - capable of indicating basicity or acidity

7 Sampling

- 7.1 GGBFS samples are to be collected in accordance with MT 108 and split in accordance with MT 607. A 50 mL sample should be provided to the Chemistry Lab for analysis.

8 Calibration and Standardization

Follow manufacturer's specifications for calibrating and standardizing the IC. Appendix A provides calibrating and standardizing specifications for a Metrohm 883 Basic IC plus for the determination of chloride.

9 Procedure

- 9.1 Weigh 0.2500 g ± 0.0005 g GGBFS into a 50 mL beaker. Record the mass.
- 9.2 Gently tap the materials to thinly spread it over the bottom of the beaker.
- 9.3 Mix 1 mL of reagent water and 200 μL of TMG Nitric Acid.
- 9.3 Add the acid/water mixture to the sample in a hood and gently break apart clumps using a glass rod.
- 9.4 Set the mixture on a warm hot plate for five minutes, intermittently grinding any clumps so the slag completely dissolves.
- 9.5 Remove the sample from the hot plate; let it cool for 10 minutes.
- 9.6 Add 1 mL of 0.7 M sodium hydroxide to the sample. Check the pH with litmus paper; continue adding sodium hydroxide or nitric acid until the pH is neutral.
- 9.7 Transfer the sample to a 100 mL volumetric flask and bring to volume with reagent water.
- 9.8 Using a syringe filter, transfer a sufficient amount of the sample to a vial for the IC.
- 9.9 Analyze the sample on the IC.

10 Report

10.1 Data Reporting and Retention for GGBFS will be reported as shown below:

Analyte	Report As	Significance
S	SO ₃	X.XX
S-	S-	X.XX
Cl-	Cl-	0.0XX

11 Validation

11.1 For validation data and quality control information consult ASTM C114 and ensure all instruments meet its conditions.

**APPENDIX A
CHLORIDE DETERMINATION IN GGBFS USING ION CHROMATOGRAPHY**

Metrohm 883 Basic IC Plus configuration parameters

Equipment Configuration

Run time: 20 minutes

Injection volume: 20 μ L

Eluent: 3.2 mM sodium carbonate and 1.0 mM sodium bicarbonate

METHODS OF SAMPLING AND TESTING
MT 538-18
METHOD OF TEST FOR CHEMICAL ANALYSIS OF BLENDED CEMENT
(Montana Method)

1 Scope

- 1.1 This test method describes the procedures used to determine the concentration of elemental oxides of blended cement samples.
- 1.1.1 Spectroscopic Determination of Elemental Oxides in Blended Cement
- 1.1.2 Spectroscopic Determination of Silicon Dioxide and Calcium Oxide in Blended Cement
- 1.1.3 Spectroscopic Determination of Sulfur Trioxide in Blended Cement
- 1.2 This test method also denotes reference test methods:
- 1.2.1 Loss on Ignition of Portland Cement – ASTM C114 Section 18
- 1.2.2 Standard Specification for Blended Hydraulic Cements – ASTM C595/C595M
- 1.2.3 Spectroscopic Determination of Elemental Oxides in Portland Cement
- 1.2.4 Insoluble Residue of Portland Cement – ASTM C114, Section 7
- 1.2.5 Sulfide Determination in Portland Cement – ASTM C114, Section 17
- 1.3 This standard does not purport to address all the safety concerns, if any, associated with its use. It is the responsibility of the user of this standard to establish appropriate safety and health practices and determine the applicability of regulatory limitations prior to use.

2 Referenced Documents**ASTM**

C114 Standard Test Methods for Chemical Analysis of Hydraulic Cement
 C595/C595M Standard Specification for Blended Hydraulic Cements
 D1193 Standard Specification for Reagent Water
 E29 Standard Practice for Using Significant Digits in Test Data to Determine Conformance with Specifications
 E542 Standard Practice for Calibration of Laboratory Volumetric Apparatus
 E694 Standard Specification for Laboratory Glass Volumetric Apparatus
 STP 985 Rapid Methods for Chemical Analysis of Hydraulic Cement

FHWA

FHWA-RD-72-41 A New Method for Rapid Cement Analysis (Atomic Absorption Spectrophotometry)

MT Materials Manual

MT 108 Sampling and Certification of Portland Cement
 MT 607 Procedure for Reducing Field Samples to Testing Size

3 Summary of Test Method3.1 *Spectroscopic Determination of Elemental Oxides in Blended Cement Samples*

In this test method, blended cement samples are dissolved in a combination of acids via a digestion in Teflon vessels secured in a microwave digestion system. The solution is diluted and analyzed by means of an Inductively Coupled Plasma – Optical Emission Spectrophotometer (ICP-OES). The following analytes are quantified as oxides: magnesium, iron, aluminum, potassium, manganese, titanium, zinc, chromium, phosphorus, strontium and sodium.

3.2 *Spectroscopic Determination of Silicon Dioxide and Calcium Oxide in Blended Cement Samples*

This test method is substantially based on the publications ASTM STP 985 and FHWA-RD-72-41. In this method, the blended cement is solubilized by fusion with a mixed lithium metaborate and lithium tetraborate powder. The produced molten glass bead is then dissolved in a weak nitric acid solution and analyzed by ICP-OES.

3.3 *Spectroscopic Determination of Sulfur Trioxide in Blended Cement*

This test method is substantially based on the publications ASTM STP 985, FHWA-RD-72-41 and the reference test method of ASTM C114. In this method, sulfur is extracted from blended cement using nitric acid and hydrogen peroxide and then quantified via ICP-OES analysis.

4 **Significance and Use**

4.1 This procedure is primarily used to provide quality assurance for blended cement samples submitted by suppliers for inclusion on the MDT Qualified Product List as well as provide analytical information for design applications using blended cement.

5 **Apparatus**

5.1 *Inductively Coupled Plasma-Optical Emission Spectrophotometer (ICP-OES)*

5.2 *Microwave digestion system* – Capable of heating samples to 200°C and maintaining that temperature for at least 30 minutes.

5.3 *Labware* – Glassware, Teflon, and Plasticware containers that have been properly cleaned and stored filled with dilute nitric acid solution (1 – 5%) for at least 2 days.

5.4 *Analytical Balances* – For the initial weighing of samples and standards, a balance with a precision of 0.0001 g should be used. For weighing material over 210 g, a balance with a precision of 0.01 g should be used.

5.5 *Muffle Furnace* – Capable of maintaining a temperature of 950°C ± 25° verified by clay pyrometric cones yearly.

6 **Reagents and Materials**

6.1 *Trace metal grade (TMG) Hydrochloric acid (HCl)*, concentrated (32-38%)

6.2 *TMG Nitric acid (HNO₃)*, concentrated (65-70%)

6.3 *Fluoroboric acid (HBF₄)*, concentrated (46-52%)

6.4 *Hydrogen Peroxide (H₂O₂)*, concentrated (30-38%)

6.5 *Reagent Water* – Purified water that meets ASTM Type II specifications or better (ASTM D1193)

6.6 *Filter paper* – Particle retention of 20 – 25 µm and a medium flowrate.

6.7 *Ultra-pure Grade Lithium Borate Flux* – composed of 66 ±10% Lithium tetraborate (Li₂B₄O₇), 33 ±10% lithium metaborate (LiBO₂) and 1 ±1% lithium bromide (LiBr)

7 **Sampling**

7.1 Blended cement samples are to be collected in accordance with MT 108 and split in accordance with MT 607. A 50 mL sample should be provided to the Chemistry Lab for analysis.

SPECTROSCOPIC DETERMINATION OF ELEMENTAL OXIDES IN BLENDED CEMENT**8 Calibration and Standardization**

Follow manufacturer's specifications for calibrating and standardizing the ICP-OES. Appendix A provides calibrating and standardizing specifications for an Agilent Radial ICP-OES for the determination of elemental oxides.

9 Procedure

- 9.1 Weigh $0.1000 \text{ g} \pm 0.0005 \text{ g}$ of blended cement onto tared waxed paper or a small weighing boat. Record the mass.
- 9.2 Transfer the sample to a Teflon insert for microwave digestion. Reweigh the waxed paper or weighing boat and note the residual mass from the sample. Record the residual mass and calculate the mass transferred to the Teflon insert.
- 9.3 In a ventilation hood, add 10.0 mL TMG Hydrochloric acid, 4.0 mL TMG Nitric acid, and 4.0 mL Fluoroboric acid to the Teflon insert using autopipettes with disposable tips. Place the Teflon insert in the carousel.
- 9.4 Once all samples have been prepared, place the carousel in the microwave digestion system. Begin the digestion process (see Appendix A for MDT digestion process). After completion of the digestion process, allow the carousel to cool before removing. The carousel may be left overnight to cool.
- 9.5 Remove a digestion vessel and open it. Rinse the sample into a clean Teflon beaker. Tare a dry 125 mL plastic sample bottle. Rinse the solution from the beaker into the plastic sample bottle. Place the plastic sample bottle on the balance and add reagent water to a mass of $100.00 \text{ g} \pm 0.05 \text{ g}$. Cap the plastic sample bottle and invert it several times to homogenize the solution.
- 9.6 Label the container with the sample number, date, analyst initials, and as blended cement.
- 9.7 Repeat Sections 9.5 and 9.6 for all samples.
- 9.8 Analyze the solutions on an ICP-OES.

SPECTROSCOPIC DETERMINATION OF SILICON DIOXIDE AND CALCIUM OXIDE IN BLENDED CEMENT

10 Calibration and Standardization

Follow manufacturer's specifications for calibrating and standardizing the ICP-OES. Appendix B provides calibrating and standardizing specifications for an Agilent Radial ICP-OES for the determination of silicon dioxide.

11 Procedure

- 11.1 Weigh 0.8000 g \pm 0.005 g of lithium borate flux into a graphite crucible.
- 11.2 Tare the flux and crucible and add 0.1000 g \pm 0.0005 g blended cement on top of the flux.
- 11.3 Fuse the graphite crucible(s) containing the samples in the muffle furnace at 950°C for 5 minutes. Do not fuse more than two crucibles at a time. Swirl the crucible to consolidate all residual sample that may be sticking to the sides of the crucible. Continue fusing for an additional 15-25 minutes at 950°C.
- 11.4 Prior to or during the fusion process, prepare an adequate number of Teflon beakers (at least 200 mL) by rinsing them copiously with reagent water. Add no less than 60 ml of water into the beakers. Place a Teflon stir bar in each beaker and cover each with a watch glass. Place the beakers on a stir plate near the furnace and stir at a rate of about two revolutions per second.
- 11.5 At the completion of the fusion process, quickly transfer the fusion bead from the graphite crucible to one of the prepared Teflon beakers. Inspect the graphite crucible for any trace of sample or fusion material; discard the sample if either are present. Add 5 ml of nitric acid, replace the watch glass on the beaker, and stir for a minimum of 30 minutes or until all material is dissolved. More acid may be needed to completely dissolve the fusion bead; add the same amount of acid to each sample in order to maintain the same acid content. If additional acid results in material coming out of solution, the sample is not suitable for analysis; discard the sample.
- 11.6 Once all the material has dissolved, prepare the stock solution by transferring the solution to a 500-mL class A volumetric flask. Bring to volume with reagent water and add nitric acid such that the concentration of nitric acid will be 15 + 485. Cover the flask with Parafilm and invert a minimum of eight times to thoroughly mix. If needed, quantitatively filter the samples.
- 11.7 Transfer the stock solution to a plastic sample bottle; discard any excess solution. Label the container with the sample number, blended cement, Ca and Si analysis, date, and analyst initials.
- 11.8 Once all the samples are prepared, analyze the solutions on an ICP-OES.

SPECTROSCOPIC DETERMINATION OF SULFUR TRIOXIDE IN BLENDED CEMENTS**12 Calibration and Standardization**

Follow manufacturer's specifications for calibrating and standardizing the ICP-OES. Appendix C provides calibrating and standardizing specifications for an Agilent Radial ICP-OES for the determination of sulfur trioxide.

13 Procedure

13.1 Weigh $0.5000 \text{ g} \pm 0.0005 \text{ g}$ blended cement directly into a dry 250 mL beaker.

Note – If a thick-walled beaker is used that is too heavy for the balance, the cement can be weighed on waxed paper or a small weighing boat and transferred. Reweigh the waxed paper or weighing to account for any cement that may have stuck to it.

13.2 Add 5.0 mL of hydrogen peroxide using an autopipette to each beaker.

13.3 Bring the solution to the 100 mL mark on the beaker with reagent water.

13.4 Add 10.0 mL of nitric acid to the beaker using an autopipette.

13.5 Add a Teflon stir bar and place on a stir plate to agitate for a minimum of 60 minutes. A good stir rate is about two revolutions per second.

13.6 Quantitatively filter into a 500 mL glass volumetric flask and rinse many times with reagent water.

13.7 Bring to volume with reagent water.

13.8 Transfer the solution into a suitable clean container for analysis. Label with the sample number, the date, analyst initials, and analyte of interest.

13.9 Once all the samples are prepared, analyze the solutions using the ICP-OES.

14 Report

14.1 Data Reporting and Retention for blended cements will be reported as shown below:

Analyte	Reported As	Significance
Ca	CaO	XX.XX
Al	Al ₂ O ₃	X.XX
Fe	Fe ₂ O ₃	X.XX
Mg	MgO	X.XX
Si	SiO ₂	XX.XX
Ti	TiO ₂	0.XX
Cr	Cr ₂ O ₃	0.0XX
K	K ₂ O	X.XXX
Mn	Mn ₂ O ₃	0.XXX
Na	Na ₂ O	0.XXX
P	P ₂ O ₅	0.XXX
Zn	ZnO	0.XXX
S	SO ₃	X.XX
S-	S-	X.XX
LOI	LOI	X.XX
ISR	ISR	0.XX
CO ₂	CO ₂	X.XX

15 Validation

15.1 For validation data and quality control information, consult ASTM C114 and ensure all instruments meet its conditions.

APPENDIX A
SPECTROSCOPIC DETERMINATION OF ELEMENTAL OXIDES IN BLENDED CEMENT

Agilent Radial ICP-OES configuration parameters**Equipment Configuration**

Nebulizer: One Neb
Spray chamber: cyclonic
Sample pump tubing: White/White
Waste pump tubing: Blue/Blue
Rinse solution: 3% Nitric acid
Torch: High solids
Power: 1.15 kW
Plasma flow: 15.0 L/min
Auxiliary flow: 1.50 L/min
Nebulizer flow: 0.75 L/min
Replicate read time: 1.00s
Instrument stabilization delay: 15s
Sample uptake delay: 45s
Pump rate: 15 rpm
Rinse time: 40s
Fast pump: yes
Replicates: 5
Viewing Height: 8mm

Line Selection for Standards, Samples, and Blanks

Al: 309.271
Cr: 205.560
Fe: 261.187
K: 766.491
Mg: 280.270
Mn: 257.610
Na: 589.592
P: 213.618
Ti: 334.941
Zn: 213.857

Calibration Agilent Radial ICP-OES

Type: Linear for all elements.

Linear-Maximum percent error of 10% and Confidence limit of 0.99%.

Calibration Standard Selection: Pick NIST or CCRL blended cement standards that provide a range covering what would likely be expected of the samples being analyzed. Usually a minimum of four should be selected. If any samples fall outside the range of the selected standards more should be selected to expand the range.

Milestone Ethos EZ microwave digestion system

Digestion program used: portcement.mpr

Heat and time: Heat to 200°C and hold temperature during a 30-minute interval. Followed by a 10-minute cooling period

Rotor: SK-10

**APPENDIX B
SPECTROSCOPIC DETERMINATION OF SILICON DIOXIDE AND CALCIUM OXIDE
IN BLENDED CEMENT**

Agilent Radial ICP-OES configuration parameters**Equipment Configuration**

Nebulizer: One Neb
Spray chamber: cyclonic
Sample pump tubing: White/White
Waste pump tubing: Blue/Blue
Rinse solution: 3% Nitric acid
Torch: High solids
Power: 1.20 kW
Plasma flow: 15.0 L/min
Auxiliary flow: 1.50 L/min
Nebulizer flow: 0.60 L/min
Replicate read time: 1.00s
Instrument stabilization delay: 15s
Sample uptake delay: 45s
Pump rate: 15 rpm
Rinse time: 40s
Fast pump: yes
Replicates: 5
Viewing Height: 11mm

Line Selection for Standards, Samples, and Blanks

Ca: 317.933
Si: 212.412

Calibration Agilent Radial ICP-OES

Type: Linear for all elements.

Linear-Maximum percent error of 10% and Confidence limit of 0.99%.

Calibration Standard Selection: Pick NIST or CCRL blended cement standards that provide a range covering what would likely be expected of the samples being analyzed. Usually a minimum of four should be selected. If any samples fall outside the range of the selected standards more should be selected to expand the range.

APPENDIX C
SPECTROSCOPIC DETERMINATION OF SULFUR TRIOXIDE IN BLENDED CEMENTS

Agilent Radial ICP-OES configuration parameters**Equipment Configuration**

Nebulizer: One Neb
Spray chamber: cyclonic
Sample pump tubing: White/White
Waste pump tubing: Blue/Blue
Rinse solution: 3% Nitric acid
Torch: High solids
Power: 1.00 kW
Plasma flow: 15.0 L/min
Auxiliary flow: 1.50 L/min
Nebulizer flow: 0.60 L/min
Replicate read time: 1.00s
Instrument stabilization delay: 15s
Sample uptake delay: 30s
Pump rate: 15 rpm
Rinse time: 40s
Fast pump: yes
Replicates: 5
Viewing Height: 11mm

Line Selection for Standards, Samples, and Blanks

S: 180.669, 181.972

Calibration Agilent Radial ICP-OES

Type: Linear for all elements.

Linear-Maximum percent error of 10% and Confidence limit of 0.99%.

Calibration Standard Selection: Pick NIST or CCRL blended cement standards that provide a range covering what would likely be expected of the samples being analyzed. Usually a minimum of four should be selected. If any samples fall outside the range of the selected standards more should be selected to expand the range.

METHODS OF SAMPLING AND TESTING
MT 548-16
METHOD OF TEST FOR ANALYSIS OF TRAFFIC PAINT
(Montana Method)

1. Scope

1.1 This method describes the procedures for analyzing physical and chemical properties of traffic paint samples including:

1.1.1 Color and Contrast Ratio – Modified ASTM D2805 and E1347

1.1.2 Viscosity – ASTM D562

1.1.3 Density – Modified ASTM D1475

1.1.4 Freeze-Thaw – primarily Modified ASTM D562 and D2243

1.1.5 Static Heat Stability

1.1.6 Bleeding Ratio – primarily Modified ASTM D868

1.1.7 Skinning and Lumps

1.1.8 Settling

1.1.9 Skinning

1.1.10 FTIR Spectra Verification – Modified ASTM D7588

1.1.11 Cracking

1.1.12 Determination of Heavy Metals

1.2 This standard involves hazardous materials, operations, and equipment. This standard does not purport to address all of the safety concerns associated with its use. It is the responsibility of the user of this procedure to establish appropriate safety and health practices and to determine the applicability of regulatory limitations prior to use.

2 Referenced Documents***ASTM Standards***

D562 Standard Test Method for Consistency of Paints Measuring Krebs Unit (KU) Viscosity Using a Stormer-Type Viscometer

D660 Standard Test Method for Evaluating Degree of Checking of Exterior Paints

D661 Standard Test Method for Evaluating Degree of Cracking of Exterior Paints

D823 Standard Practices for Producing Films of Uniform Thickness of Paint, Varnish, and Related Products on Test Panels

D868 Standard Practice for Determination of Degree of Bleeding of Traffic Paint

D1193 Standard Specification for Reagent Water

D1475 Standard Test Method for Density of Liquid Coatings, Inks, and Related Products

D2243 Standard Test Method for Freeze-Thaw Resistance of Water-Borne Coatings

D2805 Standard Test Method for Hiding Power of Paints by Reflectometry

D7588 Standard Guide for FTIR Fingerprinting of a Non-Aqueous Liquid Paint as Supplied in the Manufacturer's Container

E77 Standard Test Method for Inspection and Verification of Thermometers

E1347 Test Method for Color and Color-Difference Measurement by Tristimulus Colorimetry

3 Summary of Test Methods

- 3.1 The Static Heat test involves storing paint at an elevated temperature for a week then conducting a viscosity test on the paint.
- 3.2 The Skinning and Lumps test involves storing paint at ambient conditions then straining the paint with a 100 mesh screen.
- 3.3 The Settling test involves centrifuging paint to produce a separation of the paint components.
- 3.4 The Skinning test involves partially filling a container with paint and inspecting it after two days to see if the paint has formed a skin.
- 3.5 The Cracking test involves casting a paint film over asphalt saturated felt and examining the film for cracks after it has dried.
- 3.6 For the determination of heavy metals, the paint is analyzed for the presence of antimony (Sb), arsenic (As), cadmium (Cd), chromium (Cr), cobalt (Co), lead (Pb), mercury (Hg), and tin (Sn). Paint samples are prepared through a microwave digestion system using nitric and fluoroboric acids. The samples are then analyzed for mercury with a cold vapor technique using a vapor generation assembly (VGA) outfitted onto a flame atomic absorption spectrometer (FAAS) and for the remainder of the analytes by an inductively coupled plasma optical emission spectrometer (ICP-OES).

4 Significance and Use

- 4.1 This procedure is primarily used to provide quality assurance for traffic paint used within the Montana Department of Transportation's oversight.

5 Apparatus

- 5.1 *Analytical Balance* – Capable of measuring to 0.0001 g.
- 5.2 *Microwave digestion system* – Capable of heating samples to 200°C and maintaining that temperature for at least 10 minutes. The system must use sealable vessels that prevent the escape of vapors.
- 5.3 *ICP-OES* – Capable of measuring trace elements to low parts per billion (ppb) levels.
- 5.4 *FAAS* – Outfitted with a hollow cathode lamp (HCL) for measuring Hg and capable of being outfitted with a VGA.
- 5.5 *VGA* – Capable of cold vapor techniques for detecting mercury at low ppb to high parts per trillion (ppt) levels.
- 5.6 *Plasticware* – Suitable for trace element analysis. Properly cleaned and stored filled with dilute nitric acid solution (1 – 5%) for at least 2 days.
- 5.7 *Centrifuge* – Capable of a centrifugal force of 1112 Newtons.
- 5.8 *Asphalt Felt Paper* – 15 pound saturated asphalt felt paper.
- 5.9 *Cans* – Pint sized, lined and unlined.
- 5.10 *Screens* – 100 mesh screen capable of accommodating paint.

- 5.11 *Leneta 5C form* – an opacity chart containing a white section and a black section paint films can be applied to.
- 5.12 *Oven* – Capable of maintaining $60^{\circ}\text{C} \pm 1^{\circ}\text{C}$.

6 Reagents and Materials

- 6.1 *Trace metal grade (TMG) hydrochloric acid (HCl)* – Any commercially available brand at a concentration of 32-38%.
- 6.2 *TMG nitric acid (HNO₃)* – Any commercially available brand at a concentration of 63-70%.
- 6.3 *Fluoroboric acid (HBF₄)* – Any commercially available brand at a concentration of 46-54%.
- 6.4 *Stannous chloride (SnCl₂) solution* – 10% stannous chloride w/v and 20% TMG hydrochloric acid.
- 6.5 *1+1 hydrochloric acid* – Made with TMG HCl (e.g., Add 500 ml TMG HCl to 400 ml reagent water and dilute to 1 L).
- 6.6 *Reagent Water* – Purified water that meets ASTM Type II specifications or better (ASTM D1193)

7 Calibration and Standardization

- 7.1 Follow manufacturer's instructions for calibrating and standardizing the ICP-OES. Appendix A provides parameters for a Varian Axial ICP-OES used by MDT.
- 7.2 Follow manufacturer's instructions for calibrating and standardizing the FAAS and VGA. Appendix A provides parameters for a Varian FAAS used by MDT.
- 7.3 Check the calibration of the oven every 6 month with a thermometer verified in accordance with ASTM E77.

PROCEDURES

8 Color and Contrast Ratio

- 8.1 The paint shall be tested in accordance with ASTM D2805 and ASTM E1347 except for the following stipulations.
- 8.1.1 Rescind ASTM D2805 Sections 7.1.3 through 7.8 and replace with "15 mil films shall be cast on Leneta 5C opacity charts or equivalent and dried for a minimum of 2 hours." Use a colorimeter to determine coordinates per ASTM E1347. Use Y, x, and y coordinates with illuminant and observer settings of C and 2° when collecting readings. Record Y, x and y coordinates. Use these coordinates to calculate contrast ratio via ASTM D2805.

9 Viscosity

- 9.1 The paint shall be tested in accordance with ASTM D562.

10 Density

- 10.1 The paint shall be tested in accordance with ASTM D1475 including the following modification.
- 10.1.1 Add "Stir the sample until homogeneous." at the beginning of ASTM D1475 Section 9.1.

11 Freeze-Thaw

- 11.1 The paint shall be tested in accordance with ASTM D2243. Repeat procedures for 3 freeze-thaw cycles (ASTM D2243 Section 7.3). MDT does not require a control sample as described in ASTM D2243 Section 7.1.

- 11.2 After completion of the freeze-thaw procedures, visually examine the sample and note any signs of livering, hard settling, coagulating, lumps or coarse particles. Then determine the viscosity of the freeze-thaw sample per ASTM D562. Compare the original viscosity to the freeze-thaw viscosity and determine if there was an increase or decrease in viscosity.

12 Static Heat Stability

- 12.1 Pour paint into a pint container to within 6.4 mm (0.25 inches) of the top. Close the container, seal it with tape, and place the container in an oven maintained at $60^{\circ}\text{C} \pm 1^{\circ}\text{C}$ ($140^{\circ}\text{F} \pm 2^{\circ}\text{F}$) for 7 days.
- 12.2 After 7 days, remove the container from the oven. Equilibrate the paint at standard conditions and gently stir the paint for a minimum of 5 minutes. Visually examine the sample and note any signs of livering, hard settling, coagulating, lumps or coarse particles. Then determine the viscosity of the static heat sample per ASTM D562. Compare the original viscosity to the static heat viscosity and determine if there was an increase or decrease in viscosity.

13 Bleeding Ratio

- 13.1 The paint shall be tested in accordance with ASTM D868, except in section 7.4.1.1, replace the CIE L^* value with the reflectance coordinate Y.

14 Skinning and Lumps

- 14.1 Fill a pint container $\frac{3}{4}$ full and seal it tightly. Allow the container and sample to sit for 72 hours at ambient laboratory conditions then strain the paint through a 100 mesh screen. Note if any lumps or skin is retained on the screen.

15 Settling

- 15.1 Fill a centrifuge tube with paint and revolve it for 2 hours at laboratory ambient conditions at a speed producing a centrifugal force of 1112 Newtons (250 pound-force). Note the amount of separation of the components; there shouldn't be more than 13 mm of separation.

16 Skinning

- 16.1 Fill a lined paint can $\frac{3}{4}$ full with paint and seal tightly. Invert the can momentarily, and then turn it upright. Place the can in an area where the temperature is 21°C to 32°C for 48 hours. Do not agitate or disturb the sample. After 48 hours, open the can and inspect the paint for the presence or absence of a skin.

17 FTIR Spectra Verification

- 17.1 The paint shall be tested in accordance with ASTM D7588. Compare the acquired absorbance spectrum to a previously measured spectrum or one provided by the manufacturer. Note any significant differences between the spectra. For multicomponent paints, determine a spectrum for each component separately.

18 Cracking

- 18.1 The film shall be cast with a 380 micron (15 mil) drawdown blade on 15-pound saturated asphalt felt paper. Allow the film to dry for 24 ours then examine the paint for cracking. Cracking is understood to be any break extending through the paint film to the surface it is applied to. Partial breakthroughs known as checking are not categorized as cracking and are not addressed in this test. Consult ASTM D660 and ASTM D661 to better understand definitions of cracking and checking.

19 Heavy Metals Determination

19.1 Procedure

- 19.1.1 Weigh 0.50 g of paint or a paint component into a Teflon insert of a high pressure sample rotor system for microwave digestion. Make note of the mass to 0.0001 g.
- 19.1.2 In a properly functioning ventilation hood add 8 mL TMG nitric acid and 2 mL of fluoroboric acid to the Teflon inserts. Place the Teflon insert in the carousel.
- 19.1.3 Assemble all components required for proper microwave digestion according to the manufacturer's instructions and then run the digestion. MDT's parameters for a Milestone Ethos EZ microwave digestion system are in Appendix A.
- 19.1.4 Following the manufacturer's instructions, remove and cool the digestion vessel and open it. Rinse the sample into a clean Teflon beaker or other suitable cleaned container. Tare an appropriate storage container on the analytical balance. Rinse the sample into the storage container. Place the storage container back onto the analytical balance and dilute with reagent water to a mass of 100 g. Record the mass to nearest 0.01 g.

Note – If titanium dioxide is present in the sample, the sample should be filtered with a syringe filter prior to analyzing in order to remove small particles that could block the nebulizer.

- 19.1.5 Once all the samples have been prepared, analyze them on an ICP-OES and a FAAS outfitted with a VGA.

19.2 Calculation or Interpretation of Results

- 19.2.1 For elements Sb, As, Cd, Cr, Co, Pb, and Sn measured in mg/kg on the spectrometer, the sample concentration is calculated by multiplying the measured value by the ratio of the solution weight and then dividing by the sample weight.
- 19.2.2 For Hg measured in $\mu\text{g}/\text{kg}$ on the spectrometer, the sample concentration (mg/kg) is calculated by multiplying the measured value by the ratio of the solution weight then dividing by the sample weight then dividing by 1000.

19.3 Report

- 19.3.1 Elements Sb, As, Cd, Cr, Co, Pb, Hg, and Sn are to be reported in the units mg/kg.

APPENDIX A

Varian Axial ICP-OES configuration parameters

Equipment Configuration

- a. Nebulizer: Sea Spray
- b. Spray chamber: cyclonic
- c. Sample pump tubing: White/White
- d. Waste pump tubing: Blue/Blue
- e. Rinse Solution: 3% Nitric Acid
- f. Torch: High solids with sheath gas
- g. Sheath gas: Argon at 10mL/min
- h. Power: 1.40 kW
- i. Plasma flow: 15.0 L/min
- j. Auxiliary flow: 1.50 L/min
- k. Nebulizer flow: 0.55 L/min
- l. Replicate Read time: 10.00 s
- m. Instrument stabilization delay: 15.00s
- n. Sample uptake delay: 30.00s
- o. Pump rate: 15 rpm
- p. Rinse time: 100s
- q. Fast pump: yes
- r. Replicates: 3

Line Selection for Standard, Samples, and Blanks

- a. As 188.980, 193.696
- b. Cd 214.439
- c. Co 230.786, 231.160
- d. Cr 267.716
- e. Pb 220.353
- f. Sb 217.582, 231.146
- g. Sn 189.925, 283.998

Calibration Varian Axial ICP-OES

- a. Type: Linear for all elements
- b. Linear-Maximum percent error of 5% except Cd that can be 15% and confidence limit of 0.99%
- c. Calibration standards: Prepare calibration standards and blanks so that the sample matrices are being mimicked by compensating for the content of acids in the case of analyzing the amine component of two component paints. Prepare a total of one standard blank and three standards with varying concentrations of each desired analyte. For other paint types or components standard additions will need to be made by adding 3 differing spikes to a known portion of sample solution kept at a constant portion of each solution followed by a dilution with no spike.

An example for a stock solution taken to 500 g for standard addition spikes is as follows:

Analyte	Starting Concentration (mg/kg)	Mass Added (g)	Standard Concentration (mg/kg)
As	1000	0.5	1.0
Cd	1000	0.01	0.02
Co	1000	0.5	1.0
Cr	1000	0.1	0.2
Pb	1000	0.5	1.0
Sb	1000	0.5	1.0
Sn	1000	0.5	1.0

40 mL of TMG nitric acid and 10 mL of fluoroboric acid would added to keep the analytes stable.

Varian AA 240FS and VGA configuration parameters

Equipment configuration

- a. Measurement time: 10.00s
- b. Read delay: 115s
- c. Sample tubing: Purple/black
- d. Acid and reductant tubing: black/black
- e. Replicates standards: 3
- f. Replicates samples: 3
- g. Precision % standards: 1.0
- h. Precision % samples: 1.0
- i. Lamp Current: Recommended current on Hg lamp
- j. Slit width: 0.5R nm
- k. Reslope rate: 50
- l. Reslope standard: number 2

Wavelength selection for standards, samples, and blanks

- a. 253.7 nm

Calibration Varian AA 240FS and VGA

- a. Type: Linear
- b. Calibration standards: Prepare calibration standards and blanks so that the acid content of the sample matrices are mimicked. However do not compensate for hydrogen peroxide as it seems to keep the analysis from working properly. Prepare a total of one standard blank and three standards with varying concentrations of each desired analyte

Milestone Ethos EZ microwave digestion system

Heat and time: Heat to 200°C and hold temperature during a 20 minute interval. Followed by a 10 minute cooling period

Microwave power: 1200W (500 W for 3 vessels or less)

Rotor: SK-10

**CURRENT DATE OF REVISION
MT 600 SECTION
INFORMATION AND FIELD SAMPLING PROCEDURES**

<u>Test Method No.</u>	<u>Title</u>	<u>Pages</u>	<u>Date of Publication or Revision</u>
MT 601	Materials Sampling, Testing and Acceptance Guide Index.....	117 pp	Dec 2019
MT 602	Acceptance, Independent Assurance and Final Record Sampling	6 pp	Jun 2017
MT 603	Definitions	7 pp	Dec 2016
MT 604	Conversion Tables	1 pp	Jun 2004
MT 605	Samples and Certifications.....	1 pp	Jun 2004
MT 606	Random Sampling Techniques	8 pp	Jun 2004
MT 607	Procedure for Reducing Field Samples of Aggregates to Testing Size	3 pp	Jun 2004
MT 608	Voids Table.....	1 pp	Jun 2004
MT 609	Field Numbering Concrete Cylinders	2 pp	Feb 2016
MT 610	Numbering Subgrade Material, Surfacing Material, Bituminous Treated Material and Liquid Asphalt	1 pp	Jun 2004
MT 611	A Guide to Laboratory Forms	2 pp	Jun 2004

METHODS OF SAMPLING AND TESTING
MT 601-19
MATERIALS SAMPLING, TESTING AND ACCEPTANCE GUIDE

1 Scope

This procedure is intended to assist in determining the basis of sampling, testing, inspecting, and accepting various materials and products commonly used on highway projects.

Within this procedure is a table informing the user what tests should be performed on a particular material; the sample size; rate and frequency of sampling; responsibility for sampling, testing, collecting certification, or visually inspecting the material; and special instructions or information.

2 General

Various materials are listed in the MT 601 Table. The basis of acceptance for these materials may vary depending on the specifications, procedures or circumstances relating to these materials.

The MT 601 Table is divided into material categories, such as Aggregate, Aggregate Surfacing, etc. The user is able to click on a category to expose a table containing materials that fall within that category. Also included on each page is a link to MDT Specifications. MT 601 Table contains:

- Name of the material.
- The material code that corresponds to SiteManager.
- Tests that are routinely performed on materials for project acceptance. When possible, tests are hyperlinked to their procedure.
- Sample size required to perform the testing.
- Rate and frequency samples are to be collected.
- Responsible party for witnessing/collecting samples, collecting certifications, visually inspecting material and/or testing material.
- Notes containing special instructions or information.

3 Material Acceptance Methods

There are numerous methods for determining if a material is acceptable (i.e., meet contract requirements). The basis for acceptance of a material is defined in the contract. The SiteManager term for each acceptance method is provided in parentheses.

- Sample/Test Results (Test Results): Utilized when only test results are required to verify material quality.
- Sample/Test Results and Certification (Test Results & Certification): Utilized when test results and certification and/or visual inspection are required to verify material quality.
- Qualified Products (Approved Materials): Utilized for materials that have been approved for inclusion on MDT's QPL.
- Certification/Visual Inspection (Certification/Visual Inspection): Utilized when there is only a certification and/or visual inspection required.
- Final Record: Sample and tests taken from completed portions of a project to spot check the results obtained for contract compliance.
- Pre-Inspection: Utilized for materials tested and inspected prior to project delivery
- Mix Design: Utilized for the approval or verification of material properties and mix proportions

3.1 Sample/Test Results

Assure that the material to be incorporated into the work is sampled at the appropriate frequency. The contractor is responsible for collecting a representative sample when applicable.

All major items to be sampled and tested are listed by category in the MT 601 Table with instructions for sample size, rate/frequency of testing, sampling/witnessing and testing responsibility, and any special instructions. Whenever a conflict exists between a particular test method and MT 601, MT 601 will govern.

Acceptance - Department personnel or authorized representative will witness samples collected by the contractor.

Quality Assurance (QA) – Perform sampling for QA according to the Montana Materials Manual of Test Procedures, [Montana Standard Specifications for Road and Bridge Construction Manual](#) and any applicable [Supplemental Specifications](#) for the item to be sampled. Department personnel or authorized representative will witness samples collected by the contractor.

Independent Assurance (IA) - The Department requires all witnessing/sampling and testing for Independent Assurance purposes be accomplished by Department personnel or authorized representatives. IA samples must be collected under the direct supervision of the Materials Supervisor or their authorized representative and must not be scheduled on such an inflexible and regular routine that its frequency can be predicted; however, sufficient samples must be submitted to satisfy the frequency intended. There are two types of IA's: Comparison Testing and Procedural Checks. Independent Assurance is highlighted within the MT 601 Table in blue. Specifics on the IA procedure can be found in [MT 602 Acceptance, Independent Assurance and Final Record Sampling](#).

3.1.1 *Small Quantity Items*

Projects requiring only small quantities of materials may not require standard acceptance sampling and testing. Items such as Commercial Plant Mix under 500 tons, paint less than 25 gallons and minor quantities of concrete are examples. When items are designated as small quantities by the Project Manager, their acceptance will be based upon proper documentation, such as concrete mix design approvals, air and slump test results, aggregate gradation results, etc. The Project Manager will document in SiteManager (in the Contract Sampling and Testing window) the reason items or materials are accepted on small quantities. Buy America requirements apply to items designated as Small Quantities.

3.1.2 *Optional Samples*

All materials incorporated into the project, whether represented by actual samples or by certification, are subject to final field inspection and acceptance by the Project Manager. MDT's Project Manager has the option to obtain more than the required minimum number of samples and to submit as many additional samples as deemed necessary to ensure conformance to specifications.

3.1.3 *Maintenance Samples*

Assure the material to be incorporated into the work is sampled at the appropriate interval and/or certification of materials provided meet requirements of the maintenance contract.

3.1.4 *Preconstruction Samples*

Samples taken prior to contract work beginning for the planning and developing of construction projects.

3.2 Sample/Test Results and Certification

Assure that the material to be incorporated into the work is sampled at the appropriate interval and the contractor is responsible for taking a representative sample. Contractor provided certification of material is required for project acceptance.

3.3 Qualified Products (Approved Materials)

The Materials Bureau maintains the Qualified Products List (QPL). MDT confirms the materials appearing on the QPL meet the specifications described in the product specific item. Some materials may be accepted through the QPL or by product specific testing. Materials that are required to be on the QPL are highlighted in yellow within the table. Specifics on the QPL program can be found at the following link: [MDT's Qualified Products List](#).

3.4 Certification/Visual Inspection

Acceptance of an established product may be made by the field, based on Certificate of Compliance (Cert of Comp) or Product Data Sheet (Data Sheet), visual inspection of the material's condition and/or previous satisfactory field performance. When a Cert of Comp or Data Sheet is required, the inspector must verify that the material received matches the Cert of Comp or Data Sheet and meets the contract requirements.

- **Certificates of Compliance** – state the material meets the contract requirements. A manufacturer's authorized representative **must sign** the certificate. Clearly identify each lot of certified materials or assemblies delivered to the work in the Certificate of Compliance. Materials or assemblies used on the basis of Certificates of Compliance may be sampled and tested at any time. Materials not meeting contract requirements will be rejected.
- **Product Data Sheets** – describes the mechanical, thermal, physical, chemical, and specific properties of the product. Product Data Sheets must contain relevant standards, test methods, and results for applicable materials and subcomponents showing products to be in compliance with contract requirements.

3.4.1 Buy America

Standard Specification 106.09, 23 USC Section 313, and 23 CFR 635.410 apply to all steel and iron items designated for permanent incorporation into all MDT projects. Items designated as Category 1 or 2 will be verified as described below. For all other items documentation will be required upon request.

- Items designated as **Category 1** require supporting documentation showing all steps of manufacturing as being completed in the U.S. This includes the Mill Test Report from the original producing steel mill and certifications documenting the manufacturing processes for all subsequent fabrication, including coatings.
- Items designated as **Category 2** must have all manufacturing processes completed in the U.S.; however, to address concerns with excessive documentation, products may be certified as domestic by the fabricator. Certification by the fabricator must consist of a statement that all materials have been melted and manufactured in the U.S. and are required to be **signed** by a fabricator representative. The Department reserves the right to request additional information and documentation to verify accuracy of statement.

Material requirements for Buy America are identified on the Index table and are highlighted in gray within the table. Tests labeled as Steel Cert Category 1 and 2 are linked to MDT's [Form 406 - Contractors Certificate of Compliance for Miscellaneous Steel and Iron Items](#).

3.5 Final Records

Final Record (FR) - Samples must be taken by or under the direct supervision of the Materials Supervisor or their authorized representative and must not be scheduled on such an inflexible and regular routine that its frequency can be predicted, but sufficient samples must be submitted to satisfy the frequency intended. FR samples are to be taken in accordance with the following link: [MT 602 Acceptance, Independent Assurance and Final Record Sampling](#).

3.6 Pre-Inspection

Pre-Inspected items consist of products that undergo detailed inspections at the point of manufacture or products that are fabricated by Department Certified Plants as listed on the QPL. The purpose of Pre-Inspection is to verify that processes and materials used during fabrication meet Department requirements. One process the Department uses to accomplish this is by having a Department representative present during production to witness, sample, and test materials used. Another process the Department uses is Department Certified Plants. Department Certified Plants are producers employing internal quality control measures with an acceptable track record relating to product quality. The Department assures quality products are being produced at Department Certified Plants by implementing a combination of plant inspections, quality control system reviews, and Department witnessed or Department performed sampling and testing.

The Department representative performing pre-inspection of precast concrete products and prefabricated steel products verifies the fabricator is maintaining the supporting documentation regarding steel materials. Pre-inspected precast and prefabricated products delivered to the project must be accompanied by certification from the manufacturer stating all steel used in the product has been melted and manufactured in the United States and the fabricator has maintained supporting documentation. The Contractor is required to submit a [Form 406](#) is when inspection of the product is made at the point of production and with certification by the plant that all steel incorporated has been melted and manufactured in the United States. All supporting documentation must be maintained by the fabricator.

Pre-inspection does not constitute project acceptance. The field is responsible for final inspection and acceptance; pre-inspected products identified as not meeting contract requirements may be subject to rejection.

3.7 Mix Designs

Mix designs are submitted to MDT Helena Materials Bureau for verification and/or approval. Samples are submitted to determine if the quality of the materials and mix proportions conform to the plans and specifications. Mix Designs are highlighted within the tables in green.

4 Submittals, Documentation and Reports

A Sampling Checklist Report in SiteManager will be generated at the beginning of each contract. This report will show the material to bid item association. It will also show who is responsible for witnessing/sampling and testing the material, the sample size per unit, how many samples need to be taken, how many samples have been taken, and if there are any sample deficiencies.

Once an individual takes or witnesses a sample, a sample record is created using the Sample Information window in SiteManager. When a sample or certification must be sent to the District/Area lab or the Helena Materials Bureau, a screenshot of the "Basic Sample Data" tab is printed out and included with/or attached to the material and/or any required certification sheets. Materials are tested and the results are entered in the Test tab of the Sample Information window in SiteManager.

Once the sample record is authorized, a report will be generated containing the test results. These reports are e-mailed to the appropriate personnel per a distribution list.

MATERIAL INDEX

C - Requires Certificate of Compliance

D - Requires Product Data Sheet

BAC1 - Requires Buy America Category 1 Certification

BAC2 - Requires Buy America Category 2 Certification

QPL - Accepted only from the Qualified Products List

Material Code			Aggregate (AGGR)	Page
		701.01	Concrete Aggregate - During Production	12
		701.01.01.01	Fine Concrete Aggregate	12
		701.01.02.01	Coarse Concrete Aggregate No. 2	13
		701.01.02.02	Coarse Concrete Aggregate No. 4	13
		701.01.03.01	Combined Concrete Aggregate	13
		701.04.01.01	Bedding Material	13
		701.04.02.01	Foundation Material	14
		701.04.03.01	Granular Bedding Material	14
		701.05.00.01	Filter Material Number 1	14
		701.05.00.02	Filter Material Number 2	14
		701.06.02.01	Riprap Class 1	15
		701.06.02.02	Riprap Class 2	15
		701.06.02.03	Riprap Class 3	15
		701.07.00.01	Bank Protection Type 1	15
		701.07.00.02	Bank Protection Type 2	15
		701.07.00.03	Bank Protection Type 3	15
		701.07.00.04	Bank Protection Type 4	15
		701.09.00.01	Wall Backfill	16
		701.10.00.01	Drain Aggregate	17
C		701.11.00.01	Glass Cullet	17
		701.13.00.01	Bridge End Backfill Type 1	17
		701.13.00.02	Bridge End Backfill Type 2	18
		701.13.00.03	Bridge End Backfill Type 3	18
		PC 1	Proposed Surfacing (Gravel Pit)	19
		PC 2	Soils for Soil Survey	20
Material Code			Aggregate Surfacing (AGGS)	Page
		301.03.06.01	Shoulder Gravel	21
		302.03.01.01	Pulverize/Milled Bituminous Pavement	21
		701.02.04.01	Crushed Base Coarse Grade 5A	22
		701.02.04.02	Crushed Base Coarse Grade 6A	22
		701.02.04.03	Crushed Base Coarse Grade 7A	22
		701.02.06.01	Crushed Top Surfacing Grade 2A	23
		701.02.07.01	Crushed Top Surfacing Grade 3B	24
		701.02.08.01	Crushed Cover Aggregate Type 1	25
		701.02.08.02	Crushed Cover Aggregate Type 2	25
		701.02.08.03	Crushed Cover Aggregate Type 3	25
		701.02.09.01	Cement Treated Base	26
		701.03.00.01	Microsurfacing Aggregate Type 2	27
		701.03.00.02	Microsurfacing Aggregate Type 3	27
Material Code			Bearing Devices (BEAR)	Page
D	BAC2	711.14.00.01	Elastomeric Bearing Devices	28
D		711.20.00.01	Polytetrafluoroethylene (PTFE)	28
Material Code			Bituminous (BITM)	Page
C		702.01.01.01	Performance Graded Asphalt Binder 58-28	29
C		702.01.01.02	Performance Graded Asphalt Binder 64-22	29
C		702.01.01.03	Performance Graded Asphalt Binder 64-28	29
C		702.01.01.04	Performance Graded Asphalt Binder 70-28	29
C		702.01.02.01	SS-1h, Anionic Slow Set Emulsion	30
C		702.01.02.02	SS-1, Anionic Slow Set Emulsion	30
C		702.01.03.01	CSS-1h, Cationic Slow Set Emulsion	31
C		702.01.03.02	CSS-1, Cationic Slow Set Emulsion	31

MATERIAL INDEX

C			702.01.05.01	HF-100, High Float Emulsion	32
C			702.01.05.02	HF-300, High Float Emulsion	32
C			702.01.05.03	CHFERS-2p, Polymer Mod. Cat. High Float Rapid Set Emulsion	32
C			702.01.06.01	CRS-2, Cationic Rapid Setting Emulsion	33
C			702.01.06.02	CRS-2p, Polymer Mod. Cat. Rapid Set Emulsion	33
C			702.01.07.01	CQS-1h, Cationic Quick Setting Emulsion	34
C			702.01.07.02	CQS-1p, Polymer Mod. Cat. Quick Set Emulsion	34
C			702.01.07.03	CQS-1hp, Polymer Mod. Cat. Quick Set Emulsion	35
C			702.01.08.01	Polymer Modified Rejuvenating Emulsion	35
			Material Code	Bituminous Prime and Tack Coat (BPTC)	Page
			701.14.00.00	Blotter Material	36
			Material Code	Concrete and Structures (CONC)	Page
D		QPL	551.02.01.01	Portland Cement	37
D		QPL	551.02.01.02	Blended Cement	37
D		QPL	551.02.02.01	Fly Ash	37
D		QPL	551.02.03.01	Ground Granulated Blast Furnace Slag (GGBFS)	37
D		QPL	551.02.04.01	Microsilica/Silica Fume	38
D		QPL	551.02.05.01	Concrete Admixture	38
D		QPL	551.02.06.01	Air-entraining Agents	38
			551.03.02.02	Class General Concrete	39
			551.03.02.03	Class Pave Concrete	40
			551.03.02.05	Class SCC Concrete	42
			551.03.02.06	Class Deck Concrete	44
			551.03.02.07	Class Overlay-SF Concrete	45
			551.03.02.08	Class Overlay-LM Concrete	46
			551.03.02.09	Class Structure Concrete	47
			551.03.02.10	Class Drilled Shaft Concrete	48
			551.03.02.11	Controlled Low Strength Material-Excav	49
			551.03.02.12	Controlled Low Strength Material-Non-Excav	49
D			551.03.02.13	Pre-Packaged Concrete	49
			551.03.02.14	Lean Concrete	49
			551.03.02.15	Shotcrete	50
D			552.02.00.01	Epoxy Grout	50
C	BAC2		553.01.00.01	Prestressed Beam	51
C	BAC2		554.01.00.01	Precast Concrete Products	51
	BAC2		554.01.00.02	Cattle Guard Bases	52
D			554.01.00.03	CMU/SRW Blocks	52
D			563.02.00.01	Waterproof Membrane	52
D			713.14.00.01	Epoxy Adhesive	52
			Material Code	Concrete Sealant (CONS)	Page
D		QPL	717.01.03.01	Liquid Membrane-Forming Concrete Curing Compound	53
D		QPL	717.01.04.01	Concrete Cure and Seal Compounds	53
D		QPL	717.02.01.01	Silane Sealer	53
D		QPL	717.02.02.01	High Molecular Weight Methacrylate (HMWM)	53
D		QPL	717.02.02.02	Epoxy Bridge Deck Crack Sealant	54
D			717.02.02.03	Deck Sealant Sand	54
			Material Code	Crack Sealing (CRKS)	Page
D		QPL	403.02.00.01	Crack Sealant	55
D		QPL	403.02.00.02	Backer Rod	55
			Material Code	Excavation (EXC)	Page
			203.01.00.01	Embankment	56
			203.01.00.02	Special Borrow	57
			204.02.00.01	Stemming Aggregate for Blasting	58

MATERIAL INDEX

Material Code			Fencing (FNC)		Page
			607.02.01.01	Snow Fence Material	59
D	BAC2		712.01.02.01	Chain Link Fabric	59
D	BAC2		712.01.03.01	Chain Link Steel Post	59
D	BAC2		712.01.08.01	Chain Link Gate	59
D	BAC2		712.02.00.01	Fence Wire	60
D	BAC2		712.02.07.01	Steel Fence Post	60
			712.02.08.01	Wood Fence Post/Brace Rail	60
D	BAC2		712.02.09.01	Metal Gate	61
D			712.02.12.01	Deadman/Anchor	61
Material Code			Geotextile (GEOT)		Page
C/D		QPL	713.12.00.01	Short Term Rolled Erosion Control Blanket	62
C/D		QPL	713.12.00.02	Long Term Rolled Erosion Control Blanket	62
C/D		QPL	713.12.00.03	High Performance Rolled Erosion Control Blanket	62
C/D		QPL	713.12.00.04	Turf Reinforcement Mat - Synthetic Fiber	62
C/D		QPL	713.12.00.05	Turf Reinforcement Mat - Natural Fiber	62
C			716.00.00.01	Geocomposite Drain	62
C			716.00.00.02	Geosynthetic Clay Liner	62
C			716.00.00.03	Geomembrane	63
C			716.02.00.01	Separation Geotextile - Moderate Survivability	63
C			716.02.00.02	Separation Geotextile - High Survivability	63
C			716.03.00.01	Stabilization Geotextile	63
C			716.04.00.01	Subsurface Drain Filter-Class A-Moderate Survivability	64
C			716.04.00.02	Subsurface Drain Filter-Class B-Moderate Survivability	64
C			716.04.00.03	Subsurface Drain Filter-Class C-Moderate Survivability	64
C			716.04.00.04	Subsurface Drain Filter-Class A-High Survivability	64
C			716.04.00.05	Subsurface Drain Filter-Class B-High Survivability	64
C			716.04.00.06	Subsurface Drain Filter-Class C-High Survivability	64
C			716.05.00.01	Permanent Erosion Control-Class-A Mod Survivability	65
C			716.05.00.02	Permanent Erosion Control-Class-B Mod Survivability	65
C			716.05.00.03	Permanent Erosion Control-Class-C Mod Survivability	65
C			716.05.00.04	Permanent Erosion Control-Class-A High Survivability	65
C			716.05.00.05	Permanent Erosion Control-Class-B High Survivability	65
C			716.05.00.06	Permanent Erosion Control-Class-C High Survivability	65
D			716.06.00.01	Temporary Silt Fence	65
C			716.07.00.01	Geogrid	65
Material Code			Guardrail (GRD)		Page
D	BAC1		705.01.01.01	Metal Beam Guardrail	66
D	BAC1		705.01.01.02	Box Beam Guardrail	66
D	BAC2		705.01.01.03	Cable Guardrail/Wire Rope	66
D	BAC2		705.01.01.05	Miscellaneous Guardrail	66
			705.01.02.01	Wood Guardrail Post/Blockout	67
C			705.01.02.02	Non-Wood Blockout	67
C	BAC2		705.01.05.01	Steel Guardrail Post	67
D	BAC2	QPL	606.02.00.01	W-Beam Terminal Section	67
Material Code			Joint Material (JNT)		Page
D		QPL	707.01.00.01	Expansion Joint Fillers - Cork	68
D		QPL	707.01.01.01	Joint Sealing Material	68
C/D	BAC2		707.01.02.01	Expansion Joint System	68
D			707.01.02.02	Silicone Joint Seal	68
D			707.01.02.03	Fabric Reinforced Neoprene Joint Seal	68
D			707.01.02.04	Expansion Joint Asphalt Plug	69
D			707.01.03.01	Prefomed Expansion Joint Filler	69
D			707.02.01.01	Rubber Gasket	69
D			707.02.02.01	Flexible Joint Sealer	69

MATERIAL INDEX

Material Code				Lighting, Signals & Communication (LSM)	Page
D				Variable Message Sign	70
D				Antenna	70
D	Varies		703.00.00.00	Electrical Submittal	70
D				PVC Conduit	70
D				HDPE Conduit	70
	BAC2			Steel Conduit	70
D	BAC2			Pull Boxes	71
D	BAC2			Signal Standards Type 2/3	71
D	BAC2			Luminaire Standard Type 10	71
D	BAC2			Signal Standards Type 1	71
D				Conductor	72
D				Cable	72
D				Service & Control Assembly	72
D				Traffic Signal Cabinet	72
D				Traffic Signal Indication	72
D				LED Traffic Signal	72
D				Pedestrian Signal Indication	72
D				Detector Loop	73
D				Pedestrian Push Buttons	73
D				Luminaire Assembly	73
D				Emergency Vehicle Preemption	73
			703.14.00.01	Class 4 Treated Wood Poles	73
D				Guys & Anchors	73
Material Code				Maintenance (MAIN)	Page
D			MT 1.1	Salt 8A-R (Road Salt)	74
D			MT 1.2	Salt 8A-B (Brine Salt)	74
D			MT 1.3	Salt 8B (Wet Salt)	75
			MT 2	Salt Brine - NaCl	75
D			MT 3.1	De-Icer - MgCl ₂	76
D			MT 3.2	De-Icer - CaCl ₂	77
D			MT 3.3	De-Icer - KCH ₃ COO	78
D			MT 4.1	3/8" Sanding Material	78
D			MT 4.2	5/16" Sanding Material	79
D			MT 5	Engine Oil Analysis	79
D			MT 6	Corrosion Inhibitor	80
D			MT 7	Cold Mix Asphalt Patching Material	80
Material Code				Miscellaneous (MISC)	Page
D	BAC2	QPL	608.02.00.01	Detectable Warning Devices	81
C	BAC2		611.02.04.01	Cattle Guard Grate	81
D		QPL	623.02.00.01	Mail Box	81
			706.01.00.01	Structural Timber and Lumber	81
D			709.04.00.01	Bituminous Coatings	82
D			710.01.00.01	Steel Structure Paint	82
C			710.03.00.01	Powder Coating	82
D		QPL	710.04.00.01	Anti-Graffiti Coating	82
C/D			713.00.00.00	Miscellaneous Material Accepted on Cert	82
			713.01.00.01	Water for Concrete	82
D			713.02.00.01	Hydrated Lime	83
D			713.03.00.01	Magnesium Chloride	83
D			713.03.00.02	Calcium Chloride	83
D			713.04.00.01	Structural Cement Grout	84
D			713.04.00.02	Cement Grout	84
D			713.04.00.03	Mortar	84

MATERIAL INDEX

Material Code			Pavement Markings (PMM)		Page
D		QPL	714.03.00.01	Temporary Waterborne Paint	85
D		QPL	714.04.00.01	Waterborne Paint	85
D		QPL	714.05.00.01	High Durability Waterborne Paint	85
D		QPL	714.06.00.01	Epoxy Paint	85
D			714.07.00.01	Preformed Plastic Pavement Marking	85
D		QPL	714.08.00.01	Reflective Glass Beads - Type 1	86
D		QPL	714.08.00.02	Reflective Glass Beads - Type 2	86
Material Code			Pile (PILE)		Page
C	BAC2		559.02.03.01	Pile Driving Point	87
C	BAC2		559.02.03.02	Pile Cutting Shoe	87
C	BAC1		711.10.01.01	Structural Steel Piles	87
C	BAC1		711.10.02.01	Steel Pipe Piles	88
Material Code			Pipes (PIPE)		Page
	BAC2	QPL	708.01.00.01	Reinforced Concrete Pipe	89
	BAC2	QPL	708.01.00.02	Reinforced Concrete Box	89
	BAC2		708.02.00.01	Concrete Pressure Pipe	90
D			708.05	Plastic Pipe	90
D			708.06	Plastic Pipe	90
D			708.07	Plastic Pipe	90
D			708.08	Plastic Pipe	90
D	BAC2		709.01.01.01	Ductile Iron Water Pipe	90
C/D	BAC2		709.01.02.01	Steel Water Pipe	91
D	BAC2		709.02.00.01	Corrugated Steel Pipe	91
D	BAC2		709.03.00.01	Steel Structural Plate Pipe	91
D			709.07.00.01	Corr Aluminum Pipe	91
C/D	BAC2		709.09.00.01	Seamless Steel Pipe	92
D			709.10.00.01	Copper Pipe	92
			PC 3	Soil/Water for Pipe Corrosion	92
Material Code			Plant Mix Pavement (PMP)		Page
D		QPL	401.02.04.01	Warm Mix Additives	93
D			401.02.05.01	Anti-Stripping Additive	93
D			401.02.05.02	Recycling Agent	93
			401.03.00.01	Plant Mix Surfacing Grade S - 3/4"	94
			401.03.00.02	Plant Mix Surfacing Grade S - 1/2"	94
			401.03.00.03	Plant Mix Surfacing Grade S - 3/8"	94
			401.03.00.04	Plant Mix Seal Course	97
C			405.02.00.01	Cold Recycling Asphalt Emulsion	99
			405.03.00.01	Cold Recycled Plant Mix	99
			PC 4	Cores for Stripping Analysis	99
			PC 5	Preconstruction Soil Chemistry	99
			PC 6	Hot In Place Recycled Cores	99
Material Code			Revegetation		Page
D			610.01.00.01	Plants - Trees & Shrubs	100
			713.05.00.01	Topsoil	100
			713.05.00.02	Landscape Grade Topsoil	100
D			713.06.00.01	Weed Control Mat	100
D		QPL	713.08.00.01	Reclamation Seed	100
D			713.08.00.02	Landscaping Seed	100
D			713.09.00.01	Fertilizer	100
C/D		QPL	713.10.00.01	Mulch	101
D			713.11.00.01	Sod	101
C/D		QPL	713.13.00.01	Compost	101
Material Code			Signing (SIGN)		Page
D			704.01.01.01	Aluminum Sign Sheeting	102
D	BAC2		704.01.04.01	Steel Sign Posts	102
D	BAC2		704.01.04.02	Structural Steel Sign Posts	102

MATERIAL INDEX

D	BAC2	QPL	704.01.04.03	Breakaway Devices	102
			704.01.06.01	Treated Wood Posts & Poles	102
D			704.01.10.01	Retro-Reflective Sheeting	103
D		QPL	704.03.00.01	Surface Mount Flexible Delineators	103
D	BAC2	QPL	704.03.00.02	Drivable Flexible Delineators	103
	BAC1		704.08.01.01	Overhead Structures	103
			Material Code	Steel (STL)	Page
D	BAC2		711.00.00.01	Steel Railing	104
D	BAC2		711.01.00.01	Rock/Soil Anchor	104
D	BAC2	QPL	711.01.01.01	Rebar Grade 40	104
D	BAC2	QPL	711.01.01.02	Rebar Grade 60	104
D	BAC2	QPL	711.01.01.03	Rebar Grade 75	104
D	BAC2	QPL	711.01.01.04	Smooth Dowel Bar Grade 40	104
D		QPL	711.01.02.01	Rebar Epoxy Coating	104
D	BAC2	QPL	711.01.03.01	Reinforcing Wire, Wire Mesh	105
D	BAC2		711.01.04.01	Rebar - Corrosion Resistant - Cr - Gr100	105
D	BAC2		711.01.04.02	Rebar - Corrosion Resistant - SS - Gr 60	105
C/D	BAC1		711.02.00.01	Structural Steel	105
C/D	BAC1		711.03.00.01	Structural Steel Tubing	106
	BAC2		711.06.00.01	High Tensile Strength Bolts	106
D	BAC2		711.08.00.01	Galvanized Metal	106
C/D	BAC2		711.09.00.01	Welded Stud Shear Connectors	107
D	BAC2		711.11.00.01	Prestressing Steel	107
D	BAC2		711.12.03.01	Miscellaneous Iron Drainage Castings	107
D	BAC2	QPL	711.12.03.02	Cast Iron Inlet Frames and Grates	107
D	BAC2		711.13.00.01	Structural Anchor Bolts	108
D	BAC2		711.18.00.01	Mechanical Rebar Connectors	108
D	BAC2		711.21.00.01	High Strength Wire Rockfall Mesh	108
C/D	BAC2		711.21.00.02	Gabion Baskets - Wire and Wire Mesh	108
			Material Code	Stream Preservation (STPR)	Page
C/D			208.02.00.01	Temporary Rolled Erosion Control	109
D			208.02.00.02	Temporary Seed	109
			208.02.00.03	Stream Preservation Materials	109
			208.02.03.01	Streambed Aggregate	109
Building Materials (BM)					
			Material Code	Structure Material (STR)	Page
			BM.699.01.01	Bird Spikes	110
D			BM.699.01.02	Glue Laminated Beams	110
D			BM.699.01.03	Insulation	110
D	BAC2		BM.699.01.04	Metal Roofing	110
D	BAC2		BM.699.01.05	Metal Siding & Soffit	110
D			BM.699.01.06	Picnic Shelter (Non Precast)	111
D			BM.699.01.07	Quarry Tile	111
D	BAC2		BM.699.01.08	Roof Joist	111
D			BM.699.01.09	Interior/Exterior Building Tape & Paint	111
			BM.699.01.10	Masonry/Through Wall Flashing	112
D			BM.699.01.11	Pre-Packaged Mortar	112
D			BM.699.01.14	Masonry Siding	112
D			BM.699.01.15	Interior/Exterior Glass and Glazing	112
			Material Code	Electrical/Mechanical (ELMC)	Page
D			BM.699.02.01	Electrical	113
D			BM.699.02.02	HVAC System	113
			BM.699.02.03	Interior Fixtures & Features	113
D	BAC2		BM.699.02.04	Propane Tank	113

MATERIAL INDEX

Material Code			Plumbing (PLMB)	Page
D		BM.699.03.01	Irrigation System	114
D		BM.699.03.02	Plumbing	114
D		BM.699.03.03	Waste Water Treatment System	114
D		BM.699.03.04	Waste Water Utility Pipe & Appurtenance	114
D		BM.699.03.05	Waste Water Pumps, Fittings & Valves	114
D		BM.699.03.07	Well Pumps, Fittings & Valves	114
Material Code			Accessories (ACC)	Page
D		BM.699.04.01	Benches (Non Precast)	115
D		BM.699.04.02	Picnic Tables (Non Precast)	115
D		BM.699.04.03	Trash Receptacles (Non Precast)	115
D		BM.699.04.04	Fire Extinguishers & Cabinets	115
D		BM.699.04.05	Flag Poles (Aluminum)	115
		BM.699.04.06	Toilet Room Accessories	115
Material Code			Door/Display (DRDP)	Page
D		BM.699.05.01	Aluminum Storefront	116
D		BM.699.05.02	Display Cases	116
		BM.699.05.03	Hollow Metal Doors & Frames	116
D		BM.699.05.04	Overhead Garage Doors	116
Material Code			Scale Site Specific (SSS)	Page
D	BAC2	BM.699.06.01	Scale Pit Structural Items	117
D		BM.699.06.02	Scale Electronics, Transducers, and Displays	117

AGGREGATE

SPECIALS, SUPPLEMENTAL AND STANDARD SPECS, DETAILED DWGS

MATERIAL/ MATERIAL CODE	TESTS	SAMPLE SIZE	SAMPLE/TEST FREQUENCY	FIELD	DISTRICT/ AREA LAB	MDT HQ LAB	NOTES	
CONCRETE AGGREGATE - DURING PRODUCTION 701.01	MT 201 SAMPLING	30 LBS (14 KG)	PAVING: ONE TEST PER EVERY 1000 CU YDS (750 M ³) OTHER: ONE SAMPLE FOR EACH 200 CU YDS (150 M ³) OF CONCRETE WITH A MINIMUM OF ONE SAMPLE PER PROJECT	SAMPLE				
	MT 202 SIEVE ANALYSIS			TEST				
	INDEPENDENT ASSURANCE (COMPARISON TESTING)				FIELD	DISTRICT/ AREA LAB	MDT HQ LAB	NOTES
		MT 202 SIEVE ANALYSIS	USE FIELD TESTED SAMPLE	PAVING: ONE SAMPLE FOR EACH TWO LANE MILE (1.6 KM), MINIMUM OF ONE SAMPLE FOR PROJECTS LESS THAN ONE MILE OTHER: AT LEAST ONE SAMPLE FOR EVERY 4 SAMPLES, MINIMUM OF ONE PER PROJECT/CONTRACT		TEST	TEST	

MATERIAL/ MATERIAL CODE	TESTS	SAMPLE SIZE	SAMPLE/TEST FREQUENCY	FIELD	DISTRICT/ AREA LAB	MDT HQ LAB	NOTES
FINE CONCRETE AGGREGATE 701.01.01.01	MT 201 SAMPLING	50 LBS (23 KG)	PROPOSED SOURCE: THREE 50 LB (23 KG) COMPOSITE SAMPLES FROM EACH SOURCE		SAMPLE		If Requested
	MT 202 SIEVE ANALYSIS				TEST		
	AASHTO T 21 ORGANIC IMPURITIES IN FINE AGGREGATE					TEST	
	AASHTO T 104 SOUNDNESS SODIUM SULFATE (FINE AGG)						

AGGREGATE

SPECIALS, SUPPLEMENTAL AND STANDARD SPECS, DETAILED DWGS

MATERIAL/ MATERIAL CODE	TESTS	SAMPLE SIZE	SAMPLE/TEST FREQUENCY	FIELD	DISTRICT/ AREA LAB	MDT HQ LAB	NOTES
COARSE CONCRETE AGGREGATE No. 2 701.01.02.01 No. 4 701.01.02.02 COMBINED/ INTERMEDIATE CONCRETE AGGREGATE 701.01.03.01	MT 201 SAMPLING	50 LBS (23 KG)	PROPOSED SOURCE: THREE 50 LB (23 KG) COMPOSITE SAMPLES FROM EACH SOURCE		SAMPLE		
	MT 202 SIEVE ANALYSIS				TEST		
	AASHTO T 104 SOUNDNESS SODIUM SULFATE					TEST	
	AASHTO T 96 LOS ANGELES ABRASION						

MATERIAL/ MATERIAL CODE	TESTS	SAMPLE SIZE	SAMPLE/TEST FREQUENCY	FIELD	DISTRICT/ AREA LAB	MDT HQ LAB	NOTES
BEDDING MATERIAL 701.04.01.01	MT 201 SAMPLING	77 LBS (35 KG)	ONE TEST PER SOURCE	SAMPLE			
	MT 202 SIEVE ANALYSIS				TEST		
	MT 210 (5.5LB) PROCTOR						
	MT 230 (10LB) PROCTOR						
	MT 212 COMPACTION AND % MOISTURE (IN-PLACE DENSITY)	N/A	MINIMUM OF ONE TEST PER INSTALLATION AND PER LIFT	TEST			

MDT MATERIALS SAMPLING, TESTING, AND ACCEPTANCE GUIDE

AGGREGATE

SPECIALS, SUPPLEMENTAL AND STANDARD SPECS, DETAILED DWGS

MATERIAL/ MATERIAL CODE	TESTS	SAMPLE SIZE	SAMPLE/TEST FREQUENCY	FIELD	DISTRICT/ AREA LAB	MDT HQ LAB	NOTES
FOUNDATION MATERIAL 701.04.02.01	MT 201 SAMPLING	77 LBS (35 KG)	ONE TEST PER SOURCE	SAMPLE	TEST		
	MT 202 SIEVE ANALYSIS						
	MT 210 (5.5LB) PROCTOR						
	MT 230 (10LB) PROCTOR						
	MT 212 COMPACTION AND % MOISTURE (IN-PLACE DENSITY)	N/A	MINIMUM OF ONE TEST PER INSTALLATION AND PER LIFT	TEST			

MATERIAL/ MATERIAL CODE	TESTS	SAMPLE SIZE	SAMPLE/TEST FREQUENCY	FIELD	DISTRICT/ AREA LAB	MDT HQ LAB	NOTES
GRANULAR BEDDING MATERIAL 701.04.03.01	MT 201 SAMPLING	77 LBS (35 KG)	ONE TEST PER SOURCE	SAMPLE	TEST		
	MT 202 SIEVE ANALYSIS						

MATERIAL/ MATERIAL CODE	TESTS	SAMPLE SIZE	SAMPLE/TEST FREQUENCY	FIELD	DISTRICT/ AREA LAB	MDT HQ LAB	NOTES
FILTER MATERIAL NUMBER 701.05.00.01	MT 201 SAMPLING	30 LBS (14 KG)	ONE TEST PER SOURCE	SAMPLE			
	MT 202 SIEVE ANALYSIS			TEST			

MATERIAL/ MATERIAL CODE	TESTS	SAMPLE SIZE	SAMPLE/TEST FREQUENCY	FIELD	DISTRICT/ AREA LAB	MDT HQ LAB	NOTES
FILTER MATERIAL NUMBER 2 701.05.00.02	MT 201 SAMPLING	77 LBS (35 KG)	ONE TEST PER SOURCE	SAMPLE			
	MT 202 SIEVE ANALYSIS			TEST			

AGGREGATE

AGGREGATE

SPECIALS, SUPPLEMENTAL AND STANDARD SPECS, DETAILED DWGS

MATERIAL/ MATERIAL CODE	TESTS	SAMPLE SIZE	SAMPLE/TEST FREQUENCY	FIELD	DISTRICT/ AREA LAB	MDT HQ LAB	NOTES
RIP RAP CLASS 1 701.06.02.01	SPEC TABLE 701-21 RANDOM RIP RAP	N/A	ONE TEST PER PROJECT	TEST			
CLASS 2 701.06.02.02 CLASS 3 701.06.02.03	MDT FORM 127 RIP RAP	N/A	ONE TEST PER SOURCE	TEST			

MATERIAL/ MATERIAL CODE	TESTS	SAMPLE SIZE	SAMPLE/TEST FREQUENCY	FIELD	DISTRICT/ AREA LAB	MDT HQ LAB	NOTES
BANK PROTECTION TYPE 1 701.07.00.01	SPEC TABLE 701-22 BANK PROTECTION	N/A	ONE TEST PER PROJECT	TEST			
TYPE 2 701.07.00.02 TYPE 3 701.07.00.03 TYPE 4 701.07.00.04	CERT/ VISUAL INSPECTION	N/A	ONE TEST PER SOURCE	VISUAL			

AGGREGATE

SPECIALS, SUPPLEMENTAL AND STANDARD SPECS, DETAILED DWGS

MATERIAL/ MATERIAL CODE	TESTS	SAMPLE SIZE	SAMPLE/TEST FREQUENCY	FIELD	DISTRICT/ AREA LAB	MDT HQ LAB	NOTES			
WALL BACKFILL 701.09.00.01	MT 201 SAMPLING	77 LBS (35 KG)	ONE TEST PER SOURCE	SAMPLE	TEST					
	MT 202 SIEVE ANALYSIS									
	AASHTO T 89 LIQUID LIMIT									
	AASHTO T 90 PLASTIC LIMIT & PLASTICITY INDEX									
	AASHTO T 335 FRACTURE									
	AASHTO M 145 SOIL CLASS									
	MT 210 (5.5LB) PROCTOR									
	MT 230 (10LB) PROCTOR									
	AASHTO T 104 SOUNDNESS			30 LBS (14 KG)		ONE TEST PER SOURCE		SAMPLE	TEST	TEST MAY BE REQUIRED PER SPECIAL PROVISION
	AASHTO T 267 ORGANIC CONTENT IN SOILS									
AASHTO T 288 SOIL RESISTIVITY										
AASHTO T 289 pH OF SOIL										
AASHTO T 290 SULFATE CONTENT IN SOIL										
AASHTO T 291 CHLORIDE IN SOIL										
MT 212 COMPACTION AND % MOISTURE (IN-PLACE DENSITY)	N/A	MINIMUM OF ONE TEST PER INSTALLATION AND PER LIFT	TEST							

AGGREGATE

SPECIALS, SUPPLEMENTAL AND STANDARD SPECS, DETAILED DWGS

MATERIAL/ MATERIAL CODE	TESTS	SAMPLE SIZE	SAMPLE/TEST FREQUENCY	FIELD	DISTRICT/ AREA LAB	MDT HQ LAB	NOTES
DRAIN AGGREGATE 701.10.00.01	MT 201 SAMPLING	77 LBS (35 KG)	ONE TEST PER PROJECT	SAMPLE			
	MT 202 SIEVE ANALYSIS				TEST		

MATERIAL/ MATERIAL CODE	TESTS	SAMPLE SIZE	SAMPLE/TEST FREQUENCY	FIELD	DISTRICT/ AREA LAB	MDT HQ LAB	NOTES
GLASS CULLET 701.11.00.01	CERT/ VISUAL INSPECTION	1 EACH	ONE PER PROJECT	CERT OF COMP			

MATERIAL/ MATERIAL CODE	TESTS	SAMPLE SIZE	SAMPLE/TEST FREQUENCY	FIELD	DISTRICT/ AREA LAB	MDT HQ LAB	NOTES
BRIDGE END BACKFILL TYPE 1 701.13.00.01	MT 201 SAMPLING	77 LBS (35 KG)	ONE TEST PER SOURCE	SAMPLE			
	MT 202 SIEVE ANALYSIS						
	AASHTO T 335 FRACTURE						
	MT 210 (5.5LB) PROCTOR						
	MT 230 (10LB) PROCTOR						
	MT 212 COMPACTION AND % MOISTURE (IN-PLACE DENSITY)	N/A	MINIMUM OF ONE TEST PER INSTALLATION AND PER LIFT	TEST			

AGGREGATE

SPECIALS, SUPPLEMENTAL AND STANDARD SPECS, DETAILED DWGS

MATERIAL/ MATERIAL CODE	TESTS	SAMPLE SIZE	SAMPLE/TEST FREQUENCY	FIELD	DISTRICT/ AREA LAB	MDT HQ LAB	NOTES
BRIDGE END BACKFILL TYPE 2 701.13.00.02	MT 201 SAMPLING	77 LBS (35 KG)	ONE TEST PER SOURCE	SAMPLE	TEST		
	MT 202 SIEVE ANALYSIS						
	MT 210 (5.5LB) PROCTOR						
	MT 230 (10LB) PROCTOR						
	MT 212 COMPACTION AND % MOISTURE (IN-PLACE DENSITY)	N/A	MINIMUM OF ONE TEST PER INSTALLATION AND PER LIFT	TEST			

MATERIAL/ MATERIAL CODE	TESTS	SAMPLE SIZE	SAMPLE/TEST FREQUENCY	FIELD	DISTRICT/ AREA LAB	MDT HQ LAB	NOTES
BRIDGE END BACKFILL TYPE 3 701.13.00.03	MT 201 SAMPLING	77 LBS (35 KG)	ONE TEST PER SOURCE	SAMPLE	TEST		
	MT 202 SIEVE ANALYSIS						
	AASHTO T 89 LIQUID LIMIT						
	AASHTO T 90 PLASTIC LIMIT & PLASTICITY INDEX						
	AASHTO M 145 SOIL CLASS						
	MT 210 (5.5LB) PROCTOR						
	MT 230 (10LB) PROCTOR						
	MT 212 COMPACTION AND % MOISTURE (IN-PLACE DENSITY)	N/A	MINIMUM OF ONE TEST PER INSTALLATION AND PER LIFT	TEST			

AGGREGATE

AGGREGATE

SPECIALS, SUPPLEMENTAL AND STANDARD SPECS, DETAILED DWGS

MATERIAL/ MATERIAL CODE	TESTS	SAMPLE SIZE	SAMPLE/TEST FREQUENCY	FIELD	DISTRICT/ AREA LAB	MDT HQ LAB	NOTES	
PROPOSED SURFACING (GRAVEL PIT) PC 1	AASHTO R 58 PREPARATION	SAMPLE PER MT 201	ONE TEST PER SOURCE		VISUAL			
	MT 201 SAMPLING				SAMPLE			
	MT 202 SIEVE ANALYSIS				TEST			
	AASHTO T 89 LIQUID LIMIT							
	AASHTO T 90 PLASTIC LIMIT & PLASTICITY INDEX							
	AASHTO M 145 SOIL CLASS							
	AASHTO T 96 LOS ANGELES ABRASION							
	AASHTO T 112 CLAY LUMPS & FRIABLE PARTICLES							
	AASHTO T 327 MICRO-DEVAL							TEST
	MT 305 VOLUME SWELL- CALIPER/MERCURY							
	MT 322 ADHESION							
	AASHTO T 104 SOUNDNESS SODIUM SULFATE							
	AASHTO T 190 R-VALUE							

AGGREGATE

SPECIALS, SUPPLEMENTAL AND STANDARD SPECS, DETAILED DWGS

MATERIAL/ MATERIAL CODE	TESTS	SAMPLE SIZE	SAMPLE/TEST FREQUENCY	FIELD	DISTRICT/ AREA LAB	MDT HQ LAB	NOTES
SOILS FOR SOIL SURVEY PC 2	AASHTO R 58 PREPARATION	SAMPLE PER MT 207	ONE TEST PER LOCATION		VISUAL		THIS INFORMATION IS FOR DESIGN
	MT 207 CENTERLINE SOIL SURVEY				SAMPLE		
	MT 201 SAMPLING						
	MT 202 SIEVE ANALYSIS				TEST		
	AASHTO T 89 LIQUID LIMIT						
	AASHTO T 90 PLASTIC LIMIT & PLASTICITY INDEX						
	MT 210 (5.5LB) PROCTOR						
	MT 230 (10LB) PROCTOR						
	AASHTO M 145 SOIL CLASS						
	AASHTO T 100 SPECIFIC GRAVITY OF SOILS					TEST	
	MT 232 SOILS CORROSION						
	AASHTO T 190 R-VALUE						

AGGREGATE SURFACING

SPECIALS, SUPPLEMENTAL AND STANDARD SPECS, DETAILED DWGS

MATERIAL/ MATERIAL CODE	TESTS	SAMPLE SIZE	SAMPLE/TEST FREQUENCY	FIELD	DISTRICT/ AREA LAB	MDT HQ LAB	NOTES
SHOULDER GRAVEL 301.03.06.01	MT 201 SAMPLING	30 LBS (14 KG)	ONE TEST PER PROJECT RESAMPLE IF MATERIAL CHANGES	SAMPLE			
	MT 202 SIEVE ANALYSIS				TEST		

MATERIAL/ MATERIAL CODE	TESTS	SAMPLE SIZE	SAMPLE/TEST FREQUENCY	FIELD	DISTRICT/ AREA LAB	MDT HQ LAB	NOTES
PULVERIZED/ MILLED BITUMINOUS PAVEMENT 302.03.01.01	CERT/ VISUAL INSPECTION	N/A	ONE PER PROJECT	VISUAL			VISUALLY INSPECT SO THAT 100% OF MATERIAL PASSES 2-INCH (50 MM) SIEVE
	MT 202 SIEVE ANALYSIS	77 LBS (35 KG)	VISUALLY INSPECT UNLESS QUESTIONABLE	TEST			
	MT 230 (10LB) PROCTOR		TWO TESTS PER MATERIAL TYPE RESAMPLE IF MATERIAL CHANGES	SAMPLE	TEST		
	MT 219 CONTROL-STRIP TEST SECTION	N/A	WHEN RATIO OF BLENDED MATERIAL CHANGES BY MORE THAN 20% OR CHARACTERISTICS OR SITE CONDITIONS CHANGE	TEST			
	MT 212 COMPACTION AND % MOISTURE (IN-PLACE DENSITY)	N/A	10 TESTS PER 2000 FT (610 M)	TEST			

AGGREGATE SURFACING

SPECIALS, SUPPLEMENTAL AND STANDARD SPECS, DETAILED DWGS

MATERIAL/ MATERIAL CODE	TESTS	SAMPLE SIZE	SAMPLE/TEST FREQUENCY	FIELD	DISTRICT/ AREA LAB	MDT HQ LAB	NOTES
	MT 201 SAMPLING	77 LBS (35 KG)	1 SAMPLE FOR EACH 2,500 TONS (MT) (1,250 CU YDS (M ³)), 1 LOT = 5 SAMPLES OR APPROX. 12,500 TONS (MT) (6,250 CU YDS or (M ³))	SAMPLE			
	MT 202 SIEVE ANALYSIS			TEST			
	AASHTO T 335 FRACTURE						
CRUSHED BASE COURSE GRADE 5A 701.02.04.01	AASHTO T 89 LIQUID LIMIT	77 LBS (35 KG)	TWO TESTS PER MATERIAL TYPE RESAMPLE IF MATERIAL CHANGES	SAMPLE	TEST		
	AASHTO T 90 PLASTIC LIMIT & PLASTICITY INDEX						
	MT 230 (10LB) PROCTOR						
GRADE 6A 701.02.04.02	MT 212 COMPACTION AND % MOISTURE (IN-PLACE DENSITY)	N/A	10 TESTS PER 2000 FT (610 M)	TEST			
GRADE 7A 701.02.04.03	INDEPENDENT ASSURANCE (COMPARISON TESTING)			FIELD	DISTRICT/ AREA LAB	MDT HQ LAB	NOTES
	MT 202 SIEVE ANALYSIS	USE FIELD TESTED SAMPLE	1 SAMPLE FOR EACH 5 LOTS, MINIMUM OF 1 SAMPLE PER SOURCE		TEST	TEST	
	AASHTO T 335 FRACTURE						
	AASHTO T 89 LIQUID LIMIT		1 SAMPLE PER PROJECT PER SOURCE				
	AASHTO T 90 PLASTIC LIMIT & PLASTICITY INDEX						

AGGREGATE SURFACING

SPECIALS, SUPPLEMENTAL AND STANDARD SPECS, DETAILED DWGS

MATERIAL/ MATERIAL CODE	TESTS	SAMPLE SIZE	SAMPLE/TEST FREQUENCY	FIELD	DISTRICT/ AREA LAB	MDT HQ LAB	NOTES
CRUSHED TOP SURFACING GRADE 2A 701.02.06.01	MT 201 SAMPLING	30 LBS (14 KG)	1 SAMPLE FOR EACH 2,500 TONS (MT) (1,250 CU YDS (M3)), 1 LOT = 5 SAMPLES OR APPROX. 12,500 TONS (MT) (6,250 CU YDS or (M3))	SAMPLE			
	MT 202 SIEVE ANALYSIS			TEST			
	AASHTO T 335 FRACTURE						
	SPEC 701.02.6 DUST RATIO						
	AASHTO T 89 LIQUID LIMIT	30 LBS (14 KG)	TWO TESTS PER MATERIAL TYPE RESAMPLE IF MATERIAL CHANGES	SAMPLE	TEST		
	AASHTO T 90 PLASTIC LIMIT & PLASTICITY INDEX						
	MT 210 (5.5LB) PROCTOR						
	MT 230 (10LB) PROCTOR						
	MT 212 COMPACTION AND % MOISTURE (IN-PLACE DENSITY)	N/A	10 TESTS PER 2000 FT (610 M)	TEST			
	INDEPENDENT ASSURANCE (COMPARISON TESTING)				FIELD	DISTRICT/ AREA LAB	MDT HQ LAB
MT 202 SIEVE ANALYSIS	USE FIELD TESTED SAMPLE	1 SAMPLE FOR EACH 5 LOTS, MINIMUM OF 1 SAMPLE PER SOURCE		TEST	TEST		
AASHTO T 335 FRACTURE							
AASHTO T 89 LIQUID LIMIT		1 SAMPLE PER PROJECT PER SOURCE					
AASHTO T 90 PLASTIC LIMIT & PLASTICITY INDEX							

AGGREGATE SURFACING

SPECIALS, SUPPLEMENTAL AND STANDARD SPECS, DETAILED DWGS

MATERIAL/ MATERIAL CODE	TESTS	SAMPLE SIZE	SAMPLE/TEST FREQUENCY	FIELD	DISTRICT/ AREA LAB	MDT HQ LAB	NOTES
CRUSHED TOP SURFACING GRADE 3B 701.02.07.01	MT 201 SAMPLING	30 LBS (14 KG)	1 SAMPLE FOR EACH 2,500 TONS (MT) (1,250 CU YDS (M3)), 1 LOT = 5 SAMPLES OR APPROX. 12,500 TONS (MT) (6,250 CU YDS or (M3))	SAMPLE			
	MT 202 SIEVE ANALYSIS			TEST			
	AASHTO T 335 FRACTURE						
	SPEC 701.02.7 DUST RATIO						
	AASHTO T 89 LIQUID LIMIT	30 LBS (14 KG)	TWO TESTS PER MATERIAL TYPE RESAMPLE IF MATERIAL CHANGES	SAMPLE	TEST		
	AASHTO T 90 PLASTIC LIMIT &						
	MT 210 (5.5LB) PROCTOR						
	MT 230 (10LB) PROCTOR						
	MT 212 COMPACTION AND % MOISTURE (IN-PLACE DENSITY)	N/A	10 TESTS PER 2000 FT (610 M)	TEST			
	INDEPENDENT ASSURANCE (COMPARISON TESTING)				FIELD	DISTRICT/ AREA LAB	MDT HQ LAB
MT 202 SIEVE ANALYSIS	USE FIELD TESTED SAMPLE	1 SAMPLE FOR EACH 5 LOTS, MINIMUM OF 1 SAMPLE PER SOURCE		TEST	TEST		
AASHTO T 335 FRACTURE							
AASHTO T 89 LIQUID LIMIT		1 SAMPLE PER PROJECT PER SOURCE					
AASHTO T 90 PLASTIC LIMIT & PLASTICITY INDEX							

AGGREGATE SURFACING

SPECIALS, SUPPLEMENTAL AND STANDARD SPECS, DETAILED DWGS

MATERIAL/ MATERIAL CODE	TESTS	SAMPLE SIZE	SAMPLE/TEST FREQUENCY	FIELD	DISTRICT/ AREA LAB	MDT HQ LAB	NOTES
CRUSHED COVER AGGREGATE	MT 201 SAMPLING	30 LBS (14 KG)	1 SAMPLE FOR EACH 38,500 SQ YDS (32,000 M ²), 5 SAMPLES = 1 LOT OR APPROX. 192,500 SQ YDS (160,000 M ²)	SAMPLE			
	MT 202 SIEVE ANALYSIS			TEST			
	AASHTO T 335 FRACTURE						
INDEPENDENT ASSURANCE (COMPARISON TESTING)				FIELD	DISTRICT/ AREA LAB	MDT HQ LAB	NOTES
TYPE 1 701.02.08.01	MT 202 SIEVE ANALYSIS	USE FIELD TESTED SAMPLE	ONE TEST FOR EACH LOT		TEST	TEST	
TYPE 2 701.02.08.02	AASHTO T 335 FRACTURE						
Mix Design				FIELD	DISTRICT/ AREA LAB	MDT HQ LAB	NOTES
TYPE 3 701.02.08.03	CERT/ VISUAL INSPECTION	1 EACH	ONE MIX DESIGN PER SOURCE	MIX DESIGN			CERTIFICATION IS THE CONTRACTOR'S MIX DESIGN. APPLICATION RATES AND COMPATIBILITY TEST RESULTS ARE SUBMITTED IN THE CONTRACTOR'S MIX DESIGN. ADHESION RESULTS (MT 322) ARE AN ACCEPTABLE METHOD FOR COMPATABILITY.

AGGREGATE SURFACING

SPECIALS, SUPPLEMENTAL AND STANDARD SPECS, DETAILED DWGS

MATERIAL/ MATERIAL CODE	TESTS	SAMPLE SIZE	SAMPLE/TEST FREQUENCY	FIELD	DISTRICT/ AREA LAB	MDT HQ LAB	NOTES	
CEMENT TREATED BASE 701.02.09.01	MT 201 SAMPLING	30 LBS (14 KG)	1 SAMPLE FOR EACH 1,500 TONS (MT) (750 CU YDS (575 M ³)), 5 SAMPLES = 1 LOT	SAMPLE				
	MT 202 SIEVE ANALYSIS			TEST				
	AASHTO T 89 LIQUID LIMIT AASHTO T 90 PLASTIC LIMIT & PLASTICITY INDEX AASHTO T 134 MOISTURE - DENSITY RELATIONS OF SOIL-CEMENT		ONE TEST PER PROJECT RESAMPLE IF MATERIAL CHANGES	SAMPLE	TEST			
	MT 216 SAMPLE CTB	30 LB (14 KG)	1 SET OF CYLINDERS PER 750 CU YDS (575 M ³) 5 SAMPLES = 1 LOT	SAMPLE				
	ASTM D1633 COMPRESSIVE STRENGTH OF MOLDED SOIL-CEMENT CYLINDERS					TEST		
	MT 212 COMPACTION AND % MOISTURE (IN-PLACE DENSITY)	N/A	1 TEST PER 750 CU YDS (575 M ³) 5 SAMPLES = 1 LOT	TEST			IF COMPACTION TEST FAILS, 2 ADDITIONAL TESTS ARE TO BE COMPLETED AND THE AVERAGE OF 3 TESTS IS THE RECORDED RESULTS	
	INDEPENDENT ASSURANCE (COMPARISON TESTING)				FIELD	DISTRICT/ AREA LAB	MDT HQ LAB	NOTES
	MT 202 SIEVE ANALYSIS	USE FIELD TESTED SAMPLE	1 SAMPLE FOR EACH 5 LOTS, MINIMUM OF 1 SAMPLE PER SOURCE			TEST	TEST	
	AASHTO T 89 LIQUID LIMIT		1 SAMPLE PER PROJECT PER SOURCE					
	AASHTO T 90 PLASTIC LIMIT & PLASTICITY INDEX							
Mix Design				FIELD	DISTRICT/ AREA LAB	MDT HQ LAB	NOTES	
CERT/ VISUAL INSPECTION	1 EACH	ONE MIX DESIGN PER SOURCE	MIX DESIGN				CERTIFICATION IS THE CONTRACTOR'S MIX DESIGN	

AGGREGATE SURFACING

SPECIALS, SUPPLEMENTAL AND STANDARD SPECS, DETAILED DWGS

MATERIAL/ MATERIAL CODE	TESTS	SAMPLE SIZE	SAMPLE/TEST FREQUENCY	FIELD	DISTRICT/ AREA LAB	MDT HQ LAB	NOTES	
MICRO SURFACING AGGREGATE TYPE 2 701.03.00.01 TYPE 3 701.03.00.02	MT 201 SAMPLING	30 LBS (14 KG)	1 SAMPLE FOR EACH 300 TONS (MT), 5 SAMPLES = 1 LOT OR APPROX. 1,500 TONS (MT)	SAMPLE				
	MT 202 SIEVE ANALYSIS			TEST				
	AASHTO T 335 FRACTURE							
	INDEPENDENT ASSURANCE (COMPARISON TESTING)				FIELD	DISTRICT/ AREA LAB	MDT HQ LAB	NOTES
	MT 202 SIEVE ANALYSIS	USE FIELD	ONE TEST FOR EACH LOT		TEST	TEST		
	AASHTO T 335 FRACTURE	TESTED SAMPLE						
	Mix Design				FIELD	DISTRICT/ AREA LAB	MDT HQ LAB	NOTES
	CERT/ VISUAL INSPECTION	1 EACH	ONE MIX DESIGN PER SOURCE	MIX DESIGN			CERTIFICATION IS THE CONTRACTOR'S MIX DESIGN	

MDT MATERIALS SAMPLING, TESTING, AND ACCEPTANCE GUIDE

MT 601 (12/31/19)

BEARING DEVICES

SPECIALS, SUPPLEMENTAL AND STANDARD SPECS, DETAILED DWGS

MATERIAL/ MATERIAL CODE	TESTS	SAMPLE SIZE	SAMPLE/TEST FREQUENCY	FIELD	DISTRICT/ AREA LAB	MDT HQ LAB	NOTES
ELASTOMERIC BEARING DEVICES	CERT/ VISUAL INSPECTION	1 EACH	ONE PER LOT/ITEM	DATA SHEET			
711.14.00.01	STEEL CERT CATEGORY 2	1 EACH	ONE PER FORM 406	FORM 406			MANDATORY SUBMITTAL OF DOCUMENTATION PER SPECIFICATION 106.09

MATERIAL/ MATERIAL CODE	TESTS	SAMPLE SIZE	SAMPLE/TEST FREQUENCY	FIELD	DISTRICT/ AREA LAB	MDT HQ LAB	NOTES
POLYTETRA- FLUOROETHYLENE (PTFE) 711.20.00.01	CERT/ VISUAL INSPECTION	1 EACH	ONE PER LOT/BATCH	DATA SHEET			VERIFY ITEM MEETS MDT REQUIREMENTS AND ATTACH APPLICABLE CERT

MDT MATERIALS SAMPLING, TESTING, AND ACCEPTANCE GUIDE

MT 601 (12/31/19)

BITUMINOUS

SPECIALS, SUPPLEMENTAL AND STANDARD SPECS, DETAILED DWGS

MATERIAL/ MATERIAL CODE	TESTS	SAMPLE SIZE	SAMPLE/TEST FREQUENCY	FIELD	DISTRICT/ AREA LAB	MDT HQ LAB	NOTES	
PERFORMANCE GRADED ASPHALT BINDER 58-28 702.01.01.01 64-22 702.01.01.02 64-28 702.01.01.03 70-28 702.01.01.04	CERT/ VISUAL INSPECTION	1 EACH	ONE PER SHIPMENT	CERT OF COMP				
	MT 302 SAMPLING	2 - 1 PINT (2-500 mL) SPECIMEN IN METAL CANS	1 SAMPLE PER 25 TONS (MT) OF ASPHALT BINDER (1 LOT = 150 TONS (MT) OF ASPHALT BINDER) COMMERCIAL MIXES 1 SAMPLE PER 450 TONS (MT) OF PLANT MIX SURFACING (1 LOT = 2700 TONS (MT) OF PLANT MIX SURFACING)	SAMPLE				
	AASHTO T 316 VISCOSITY BY ROTATIONAL VISCOMETER							
	AASHTO T 48 CLEVELAND OPEN CUP							
	AASHTO T 228 SPECIFIC GRAVITY OF ASPHALT MATERIALS							
	AASHTO T 315 DYNAMIC SHEAR RHEOMETER							
	AASHTO T 240 ROLLING THIN-FILM OVEN							
	AASHTO R 28 PRESSURIZED AGING VESSEL							
	AASHTO T 313 BENDING BEAM RHEOMETER							
	AASHTO T 51 DUCTILITY OF ASPHALT							
	INDEPENDENT ASSURANCE (PROCEDURAL CHECK)				FIELD	DISTRICT/ AREA LAB		MDT HQ LAB
	MT 302 SAMPLING	N/A	1 PER 5 LOTS, MINIMUM OF 1 PER PROJECT (750 TONS OF ASPHALT BINDER)		CHECK			

MDT MATERIALS SAMPLING, TESTING, AND ACCEPTANCE GUIDE

MT 601 (12/31/19)

BITUMINOUS

SPECIALS, SUPPLEMENTAL AND STANDARD SPECS, DETAILED DWGS

MATERIAL/ MATERIAL CODE	TESTS	SAMPLE SIZE	SAMPLE/TEST FREQUENCY	FIELD	DISTRICT/ AREA LAB	MDT HQ LAB	NOTES
SS-1H ANIONIC SLOW SET EMULSION 702.01.02.01	CERT/ VISUAL INSPECTION	1 EACH	ONE PER SHIPMENT	CERT OF COMP			QUALIFIED PRODUCTS LIST
	MT 302 SAMPLING	2 - 1 QT (2 - 1 L) SPECIMEN IN PLASTIC BOTTLES	ONE SAMPLE PER TANKER OR TRAILER	SAMPLE			SAMPLE REQUIRED ONLY IF NOT ON THE QUALIFIED PRODUCTS LIST
	AASHTO T 72 SAYBOLT VISCOSITY					MINIMUM OF ONE TEST PER PROJECT	
	AASHTO T 49 PENETRATION OF BITUMINOUS MATERIALS						
	AASHTO T 59 EMULSIFIED ASPHALTS					TEST	
							PRIMARY TEST METHOD EVAPORATIVE DISTILLATION SECONDARY TEST METHOD HIGH TEMPERATURE DISTILLATION

MATERIAL/ MATERIAL CODE	TESTS	SAMPLE SIZE	SAMPLE/TEST FREQUENCY	FIELD	DISTRICT/ AREA LAB	MDT HQ LAB	NOTES
SS-1 ANIONIC SLOW SET EMULSION 702.01.02.02	CERT/ VISUAL INSPECTION	1 EACH	ONE PER SHIPMENT	CERT OF COMP			QUALIFIED PRODUCTS LIST
	MT 302 SAMPLING	2 - 1 QT (2 - 1 L) SPECIMEN IN PLASTIC BOTTLES	ONE SAMPLE PER TANKER OR TRAILER	SAMPLE			SAMPLE REQUIRED ONLY IF NOT ON THE QUALIFIED PRODUCTS LIST
	AASHTO T 72 SAYBOLT VISCOSITY					MINIMUM OF ONE TEST PER PROJECT	
	AASHTO T 49 PENETRATION OF BITUMINOUS MATERIALS						
	AASHTO T 59 EMULSIFIED ASPHALTS					TEST	
							PRIMARY TEST METHOD EVAPORATIVE DISTILLATION SECONDARY TEST METHOD HIGH TEMPERATURE DISTILLATION

BITUMINOUS

MDT MATERIALS SAMPLING, TESTING, AND ACCEPTANCE GUIDE

MT 601 (12/31/19)

BITUMINOUS

SPECIALS, SUPPLEMENTAL AND STANDARD SPECS, DETAILED DWGS

MATERIAL/ MATERIAL CODE	TESTS	SAMPLE SIZE	SAMPLE/TEST FREQUENCY	FIELD	DISTRICT/ AREA LAB	MDT HQ LAB	NOTES
CSS-1H CATIONIC SLOW SET EMULSION 702.01.03.01	CERT/ VISUAL INSPECTION	1 EACH	ONE PER SHIPMENT	CERT OF COMP			QUALIFIED PRODUCTS LIST
	MT 302 SAMPLING	2 - 1 QT (2 - 1 L) SPECIMEN IN PLASTIC BOTTLES	ONE SAMPLE PER TANKER OR TRAILER	SAMPLE			SAMPLE REQUIRED ONLY IF NOT ON THE QUALIFIED PRODUCTS LIST
	AASHTO T 72 SAYBOLT VISCOSITY					MINIMUM OF ONE TEST PER PROJECT	
	AASHTO T 49 PENETRATION OF BITUMINOUS MATERIALS						
	AASHTO T 59 EMULSIFIED ASPHALTS					TEST	PRIMARY TEST METHOD EVAPORATIVE DISTILLATION SECONDARY TEST METHOD HIGH TEMPERATURE DISTILLATION

MATERIAL/ MATERIAL CODE	TESTS	SAMPLE SIZE	SAMPLE/TEST FREQUENCY	FIELD	DISTRICT/ AREA LAB	MDT HQ LAB	NOTES
CSS-1 CATIONIC SLOW SET EMULSION 702.01.03.02	CERT/ VISUAL INSPECTION	1 EACH	ONE PER SHIPMENT	CERT OF COMP			QUALIFIED PRODUCTS LIST
	MT 302 SAMPLING	2 - 1 QT (2 - 1 L) SPECIMEN IN PLASTIC BOTTLES	ONE SAMPLE PER TANKER OR TRAILER	SAMPLE			SAMPLE REQUIRED ONLY IF NOT ON THE QUALIFIED PRODUCTS LIST
	AASHTO T 72 SAYBOLT VISCOSITY					MINIMUM OF ONE TEST PER PROJECT	
	AASHTO T 49 PENETRATION OF BITUMINOUS MATERIALS						
	AASHTO T 59 EMULSIFIED ASPHALTS					TEST	PRIMARY TEST METHOD EVAPORATIVE DISTILLATION SECONDARY TEST METHOD HIGH TEMPERATURE DISTILLATION

BITUMINOUS

MDT MATERIALS SAMPLING, TESTING, AND ACCEPTANCE GUIDE

MT 601 (12/31/19)

BITUMINOUS

SPECIALS, SUPPLEMENTAL AND STANDARD SPECS, DETAILED DWGS

MATERIAL/ MATERIAL CODE	TESTS	SAMPLE SIZE	SAMPLE/TEST FREQUENCY	FIELD	DISTRICT/ AREA LAB	MDT HQ LAB	NOTES
HIGH FLOAT EMULSION HF-100 702.01.05.01 HF-300 702.01.05.02	CERT/ VISUAL INSPECTION	1 EACH	ONE PER SHIPMENT	CERT OF COMP			
	MT 302 SAMPLING	2 - 1 QT (2 - 1 L) SPECIMEN IN PLASTIC BOTTLES	ONE SAMPLE PER TANKER OR TRAILER	SAMPLE			
	AASHTO T 49 PENETRATION OF BITUMINOUS MATERIALS						
	AASHTO T 59 EMULSIFIED ASPHALTS					TEST	PARTICLE CHARGE TEST IS PERFORMED <u>PRIMARY TEST METHOD</u> EVAPORATIVE DISTILLATION <u>SECONDARY TEST METHOD</u> HIGH TEMPERATURE DISTILLATION
AASHTO T 72 SAYBOLT VISCOSITY						MINIMUM OF ONE TEST PER PROJECT	

MATERIAL/ MATERIAL CODE	TESTS	SAMPLE SIZE	SAMPLE/TEST FREQUENCY	FIELD	DISTRICT/ AREA LAB	MDT HQ LAB	NOTES
CHFRS-2P POLYMER MODIFIED CATIONIC HIGH FLOAT RAPID SET EMULSION 702.01.05.03	CERT/ VISUAL INSPECTION	1 EACH	ONE PER SHIPMENT	CERT OF COMP			
	MT 302 SAMPLING	2 - 1 QT (2 - 1 L) SPECIMEN IN PLASTIC BOTTLES	ONE SAMPLE PER TANKER OR TRAILER	SAMPLE			
	AASHTO T 72 SAYBOLT VISCOSITY						MINIMUM OF ONE TEST PER PROJECT
	AASHTO T 49 PENETRATION OF BITUMINOUS MATERIALS					TEST	
AASHTO T 59 TESTING EMULSIFIED ASPHALTS						PARTICLE CHARGE TEST IS PERFORMED <u>PRIMARY TEST METHOD</u> EVAPORATIVE DISTILLATION <u>SECONDARY TEST METHOD</u> HIGH TEMPERATURE DISTILLATION	

BITUMINOUS

MDT MATERIALS SAMPLING, TESTING, AND ACCEPTANCE GUIDE

MT 601 (12/31/19)

BITUMINOUS

SPECIALS, SUPPLEMENTAL AND STANDARD SPECS, DETAILED DWGS

MATERIAL/ MATERIAL CODE	TESTS	SAMPLE SIZE	SAMPLE/TEST FREQUENCY	FIELD	DISTRICT/ AREA LAB	MDT HQ LAB	NOTES
CRS-2 CATIONIC RAPID SETTING EMULSION 702.01.06.01	CERT/ VISUAL INSPECTION	1 EACH	ONE PER SHIPMENT	CERT OF COMP			
	MT 302 SAMPLING	2 - 1 QT (2 - 1 L) SPECIMEN IN PLASTIC BOTTLES	ONE SAMPLE PER TANKER OR TRAILER	SAMPLE			
	AASHTO T 72 SAYBOLT VISCOSITY						MINIMUM OF ONE TEST PER PROJECT
	AASHTO T 49 PENETRATION OF BITUMINOUS MATERIALS						
	AASHTO T 59 TESTING EMULSIFIED ASPHALTS						PARTICLE CHARGE TEST IS PERFORMED <u>PRIMARY TEST METHOD</u> EVAPORATIVE DISTILLATION <u>SECONDARY TEST METHOD</u> HIGH TEMPERATURE DISTILLATION

MATERIAL/ MATERIAL CODE	TESTS	SAMPLE SIZE	SAMPLE/TEST FREQUENCY	FIELD	DISTRICT/ AREA LAB	MDT HQ LAB	NOTES
CRS-2P POLYMER MODIFIED CATIONIC RAPID SET EMULSION 702.01.06.02	CERT/ VISUAL INSPECTION	1 EACH	ONE PER SHIPMENT	CERT OF COMP			
	MT 302 SAMPLING	2 - 1 QT (2 - 1 L) SPECIMEN IN PLASTIC BOTTLES	ONE SAMPLE PER TANKER OR TRAILER	SAMPLE			
	AASHTO T 72 SAYBOLT VISCOSITY						MINIMUM OF ONE TEST PER PROJECT
	AASHTO T 49 PENETRATION OF BITUMINOUS MATERIALS						
	AASHTO T 59 TESTING EMULSIFIED ASPHALTS						PARTICLE CHARGE TEST IS PERFORMED <u>PRIMARY TEST METHOD</u> EVAPORATIVE DISTILLATION <u>SECONDARY TEST METHOD</u> HIGH TEMPERATURE DISTILLATION

BITUMINOUS

MDT MATERIALS SAMPLING, TESTING, AND ACCEPTANCE GUIDE

MT 601 (12/31/19)

BITUMINOUS

SPECIALS, SUPPLEMENTAL AND STANDARD SPECS, DETAILED DWGS

MATERIAL/ MATERIAL CODE	TESTS	SAMPLE SIZE	SAMPLE/TEST FREQUENCY	FIELD	DISTRICT/ AREA LAB	MDT HQ LAB	NOTES
CQS-1h CATIONIC QUICK SETTING EMULSION 702.01.07.01	CERT/ VISUAL INSPECTION	1 EACH	ONE PER SHIPMENT	CERT OF COMP			
	MT 302 SAMPLING	2 - 1 QT (2 - 1 L) SPECIMEN IN PLASTIC BOTTLES	ONE SAMPLE PER TANKER OR TRAILER	SAMPLE			
	AASHTO T 72 SAYBOLT VISCOSITY						MINIMUM OF ONE TEST PER PROJECT
	AASHTO T 49 PENETRATION OF BITUMINOUS MATERIALS						
AASHTO T 59 TESTING EMULSIFIED ASPHALTS					TEST	PARTICLE CHARGE TEST IS PERFORMED <u>PRIMARY TEST METHOD</u> EVAPORATIVE DISTILLATION <u>SECONDARY TEST METHOD</u> HIGH TEMPERATURE DISTILLATION	

MATERIAL/ MATERIAL CODE	TESTS	SAMPLE SIZE	SAMPLE/TEST FREQUENCY	FIELD	DISTRICT/ AREA LAB	MDT HQ LAB	NOTES
CQS-1P POLYMER MODIFIED CATIONIC QUICK SET EMULSION 702.01.07.02	CERT/ VISUAL INSPECTION	1 EACH	ONE PER SHIPMENT	CERT OF COMP			
	MT 302 SAMPLING	2 - 1 QT (2 - 1 L) SPECIMEN IN PLASTIC BOTTLES	ONE SAMPLE PER TANKER OR TRAILER	SAMPLE			
	AASHTO T 72 SAYBOLT VISCOSITY						MINIMUM OF ONE TEST PER PROJECT
	AASHTO T 49 PENETRATION OF BITUMINOUS MATERIALS						
AASHTO T 59 TESTING EMULSIFIED ASPHALTS					TEST	PARTICLE CHARGE TEST IS PERFORMED <u>PRIMARY TEST METHOD</u> EVAPORATIVE DISTILLATION <u>SECONDARY TEST METHOD</u> HIGH TEMPERATURE DISTILLATION	

BITUMINOUS

MDT MATERIALS SAMPLING, TESTING, AND ACCEPTANCE GUIDE

MT 601 (12/31/19)

BITUMINOUS

SPECIALS, SUPPLEMENTAL AND STANDARD SPECS, DETAILED DWGS

MATERIAL/ MATERIAL CODE	TESTS	SAMPLE SIZE	SAMPLE/TEST FREQUENCY	FIELD	DISTRICT/ AREA LAB	MDT HQ LAB	NOTES
CQS-1HP POLYMER MODIFIED CATIONIC QUICK SET EMULSION 702.01.07.03	CERT/ VISUAL INSPECTION	1 EACH	ONE PER SHIPMENT	CERT OF COMP			
	MT 302 SAMPLING	2 - 1 QT (2 - 1 L) SPECIMEN IN PLASTIC BOTTLES	ONE SAMPLE PER TANKER OR TRAILER	SAMPLE			
	AASHTO T 72 SAYBOLT VISCOSITY						MINIMUM OF ONE TEST PER PROJECT
	AASHTO T 49 PENETRATION OF BITUMINOUS MATERIALS						
	AASHTO T 59 TESTING EMULSIFIED ASPHALTS						PARTICLE CHARGE TEST IS PERFORMED <u>PRIMARY TEST METHOD</u> EVAPORATIVE DISTILLATION <u>SECONDARY TEST METHOD</u> HIGH TEMPERATURE DISTILLATION
					TEST		

MATERIAL/ MATERIAL CODE	TESTS	SAMPLE SIZE	SAMPLE/TEST FREQUENCY	FIELD	DISTRICT/ AREA LAB	MDT HQ LAB	NOTES
POLYMER MODIFIED REJUVENATING EMULSION 702.01.08.01	CERT/ VISUAL INSPECTION	1 EACH	ONE PER SHIPMENT	CERT OF COMP			
	MT 302 SAMPLING	2 - 1 QT (2 - 1 L) SPECIMEN IN PLASTIC BOTTLES	ONE SAMPLE PER TANKER OR TRAILER	SAMPLE			
	AASHTO T 72 SAYBOLT VISCOSITY						MINIMUM OF ONE TEST PER PROJECT
	AASHTO T 49 PENETRATION OF BITUMINOUS MATERIALS						
	AASHTO T 59 TESTING EMULSIFIED ASPHALTS						PARTICLE CHARGE TEST IS PERFORMED <u>PRIMARY TEST METHOD</u> EVAPORATIVE DISTILLATION <u>SECONDARY TEST METHOD</u> HIGH TEMPERATURE DISTILLATION
					TEST		

BITUMINOUS

MDT MATERIALS SAMPLING, TESTING, AND ACCEPTANCE GUIDE
 SPECIALS, SUPPLEMENTAL AND STANDARD SPECS, DETAILED DWGS

MT 601 (12/31/19)

BITUMINOUS PRIME & TACK COAT

MATERIAL/ MATERIAL CODE	TESTS	SAMPLE SIZE	SAMPLE/TEST FREQUENCY	FIELD	DISTRICT/ AREA LAB	MDT HQ LAB	NOTES
BLOTTER MATERIAL 701.14.00.00	MT 201 SAMPLING	30 LBS (14 KG)	ONE TEST PER PROJECT	SAMPLE	TEST		
	MT 202 SIEVE ANALYSIS						
	AASHTO T 89 LIQUID LIMIT						
	AASHTO T 90 PLASTIC LIMIT & PLASTICITY INDEX						

BITUMINOUS PRIME TACK COAT

CONCRETE AND STRUCTURES

SPECIALS, SUPPLEMENTAL AND STANDARD SPECS, DETAILED DWGS

MATERIAL/ MATERIAL CODE	TESTS	SAMPLE SIZE	SAMPLE/TEST FREQUENCY	FIELD	DISTRICT/ AREA LAB	MDT HQ LAB	NOTES
PORTLAND CEMENT 551.02.01.01	CERT/ VISUAL INSPECTION	1 EACH	ONE PER GRIND/BIN/SHIPMENT	DATA SHEET			ACCEPTANCE ONLY FROM THE QUALIFIED PRODUCTS LIST
BLENDED CEMENT 551.02.01.02	CERT/ VISUAL INSPECTION	1 EACH	ONE PER GRIND/BIN/SHIPMENT	DATA SHEET			ACCEPTANCE ONLY FROM THE QUALIFIED PRODUCTS LIST VERIFY MATERIAL USED IS INCLUDED IN THE CONCRETE MIX DESIGN
FLY ASH 551.02.02.01	CERT/ VISUAL INSPECTION	1 EACH	ONE PER GRIND/BIN/SHIPMENT	DATA SHEET			ACCEPTANCE ONLY FROM THE QUALIFIED PRODUCTS LIST VERIFY MATERIAL USED IS INCLUDED IN THE CONCRETE MIX DESIGN
GROUND GRANULATED BLAST FURNACE SLAG (GGBFS) 551.02.03.01	CERT/ VISUAL INSPECTION	1 EACH	ONE PER GRIND/BIN/SHIPMENT	DATA SHEET			ACCEPTANCE ONLY FROM THE QUALIFIED PRODUCTS LIST VERIFY MATERIAL USED IS INCLUDED IN THE CONCRETE MIX DESIGN

CONCRETE AND STRUCTURES

SPECIALS, SUPPLEMENTAL AND STANDARD SPECS, DETAILED DWGS

MATERIAL/ MATERIAL CODE	TESTS	SAMPLE SIZE	SAMPLE/TEST FREQUENCY	FIELD	DISTRICT/ AREA LAB	MDT HQ LAB	NOTES
MICROSILICA /SILICA FUME 551.02.04.01	CERT/ VISUAL INSPECTION	1 EACH	ONE PER GRIND/BIN/SHIPMENT	DATA SHEET			ACCEPTANCE ONLY FROM THE QUALIFIED PRODUCTS LIST VERIFY MATERIAL USED IS INCLUDED IN THE CONCRETE MIX DESIGN
MATERIAL/ MATERIAL CODE	TESTS	SAMPLE SIZE	SAMPLE/TEST FREQUENCY	FIELD	DISTRICT/ AREA LAB	MDT HQ LAB	NOTES
CONCRETE ADMIXTURE 551.02.05.01	CERT/ VISUAL INSPECTION	1 EACH	ONE PER TYPE OF ADMIXTURE	DATA SHEET			ACCEPTANCE ONLY FROM THE QUALIFIED PRODUCTS LIST VERIFY MATERIAL USED IS INCLUDED IN THE CONCRETE MIX DESIGN
MATERIAL/ MATERIAL CODE	TESTS	SAMPLE SIZE	SAMPLE/TEST FREQUENCY	FIELD	DISTRICT/ AREA LAB	MDT HQ LAB	NOTES
AIR-ENTRAINING AGENTS 551.02.06.01	CERT/ VISUAL INSPECTION	1 EACH	ONE PER GRIND/BIN/SHIPMENT	DATA SHEET			ACCEPTANCE ONLY FROM THE QUALIFIED PRODUCTS LIST VERIFY MATERIAL USED IS INCLUDED IN THE CONCRETE MIX DESIGN

CONCRETE AND STRUCTURES

SPECIALS, SUPPLEMENTAL AND STANDARD SPECS, DETAILED DWGS

MATERIAL/ MATERIAL CODE	TESTS	SAMPLE SIZE	SAMPLE/TEST FREQUENCY	FIELD	DISTRICT/ AREA LAB	MDT HQ LAB	NOTES	
CLASS GENERAL CONCRETE	AASHTO R 60 SAMPLING FRESH CONCRETE	REFER TO TEST FOR SIZE		SAMPLE				
	MT 101 COMPRESSIVE STRENGTH CYLINDERS	1 CU FT (0.03 M ³)	MINIMUM OF 2 SETS PER LOT (200 YD ³ (150 M ³) OR EACH DAY'S POUR WHICHEVER IS LESS)	SAMPLE		TEST	1 SET MAY REPRESENT POURS OF 30 YD ³ (23 M ³) OR LESS [551.03.8(B)(1)(a)]	
	AASHTO T 152 AIR CONTENT	1 CU FT (0.03 M ³)	ONE TEST EVERY 24 YD ³ (18 M ³) AND WHEN COMPRESSIVE STRENGTH CYLINDERS ARE MADE	SAMPLE TEST			INCLUDE IN QA	
	AASHTO T 119 SLUMP						TEST EACH LOAD WHEN INCONSISTENT OR FAILING TEST RESULTS ARE ENCOUNTERED	
	AASHTO T 309 TEMPERATURE OF FRESHLY MIXED CONCRETE							
	AASHTO T 121 UNIT WEIGHT						FOR INFORMATION ONLY	
	INDEPENDENT ASSURANCE (PROCEDURAL CHECK)				FIELD	DISTRICT/ AREA LAB	MDT HQ LAB	NOTES
	551.03.02.02	AASHTO R 60 SAMPLING FRESH CONCRETE	USE FIELD TESTED SAMPLE	ONE PER 400 CU YDS (300 M ³) OR A MINIMUM OF ONE PER PROJECT		CHECK	CHECK	PROCEDURAL CHECK MAY BE PERFORMED BY THE DISTRICT/AREA LAB
		AASHTO T 152 AIR CONTENT						
		AASHTO T 119 SLUMP		ONE SET OF FOUR CYLINDERS PER 400 CU YDS (300 M ³) OR A MINIMUM OF ONE SET PER PROJECT				
MT 101 COMPRESSIVE STRENGTH CYLINDERS								
Mix Design				FIELD	DISTRICT/ AREA LAB	MDT HQ LAB	NOTES	
	CERT/ VISUAL INSPECTION	1 EACH	ONE MIX DESIGN PER BID ITEM	MIX DESIGN		APPROVAL	CERTIFICATION IS THE CONTRACTOR'S MIX DESIGN. SEPARATE MIX DESIGNS NEEDED ONLY WHEN CONCRETE REQUIREMENTS VARY.	

CONCRETE AND STRUCTURES

SPECIALS, SUPPLEMENTAL AND STANDARD SPECS, DETAILED DWGS

MATERIAL/ MATERIAL CODE	TESTS	SAMPLE SIZE	SAMPLE/TEST FREQUENCY	FIELD	DISTRICT/ AREA LAB	MDT HQ LAB	NOTES
CLASS PAVE CONCRETE 551.03.02.03	AASHTO R 60 SAMPLING FRESH CONCRETE	REFER TO TEST FOR SIZE		SAMPLE			
	MT 101 COMPRESSIVE STRENGTH CYLINDERS	1 CU FT (0.03 M ³)	MINIMUM OF 2 SETS PER LOT (1000 YD ³ (750 M ³) OR EACH DAY'S POUR WHICHEVER IS LESS)	SAMPLE		TEST	1 SET MAY REPRESENT POURS OF 30 YD ³ (23 M ³) OR LESS [551.03.8(B)(1)(a)]
	AASHTO T 152 AIR CONTENT	1 CU FT (0.03 M ³)	ONE TEST EVERY 24 YD ³ (18 M ³) AND WHEN COMPRESSIVE STRENGTH CYLINDERS ARE MADE	SAMPLE TEST			INCLUDE IN QA
	AASHTO T 119 SLUMP						TEST EACH LOAD WHEN INCONSISTENT OR FAILING TEST RESULTS ARE ENCOUNTERED
	AASHTO T 309 TEMPERATURE OF FRESHLY MIXED CONCRETE						
	MT 103 THICKNESS OF CONCRETE USING A THICKNESS GAUGE	N/A	MIN OF ONE TEST PER 1000 FEET (300 M) OF TRAFFIC LANE OF PAVEMENT PLACED	SAMPLE TEST			PRIMARY TEST
	AASHTO T 148 MEASURING LENGTH OF CORES						SECONDARY TEST
	AASHTO T 24 OBTAIN AND TEST CONCRETE CORES						NOTE: USE ONLY IF THIN SECTIONS ARE IDENTIFIED PER MT 103 DEFICIENCIES ARE IDENTIFIED IN MDT STANDARD SPECS SECTION 501.03.20
AASHTO T 121 UNIT WEIGHT						FOR INFORMATION ONLY	

CONCRETE AND STRUCTURES

SPECIALS, SUPPLEMENTAL AND STANDARD SPECS, DETAILED DWGS

MATERIAL/ MATERIAL CODE	INDEPENDENT ASSURANCE (PROCEDURAL CHECK)			FIELD	DISTRICT/ AREA LAB	MDT HQ LAB	NOTES
CLASS PAVE CONCRETE 551.03.02.03	AASHTO R 60 SAMPLING FRESH CONCRETE	USE FIELD TESTED SAMPLE	ONE PER 5000 CU YDS (3800 M ³) OR A MINIMUM OF ONE PER PROJECT		CHECK	CHECK	PROCEDURAL CHECK MAY BE PERFORMED BY THE DISTRICT/AREA LAB
	AASHTO T 152 AIR CONTENT						
	AASHTO T 119 SLUMP		ONE SET OF FOUR CYLINDERS PER 5000 CU YDS (M ³) OR A MINIMUM OF ONE SET PER PROJECT				
	MT 101 COMPRESSIVE STRENGTH CYLINDERS						
Mix Design				FIELD	DISTRICT/ AREA LAB	MDT HQ LAB	NOTES
CERT/ VISUAL INSPECTION	1 EACH	ONE MIX DESIGN PER BID ITEM	MIX DESIGN		APPROVAL	CERTIFICATION IS THE CONTRACTOR'S MIX DESIGN. SEPARATE MIX DESIGNS NEEDED ONLY WHEN CONCRETE REQUIREMENTS VARY.	

CONCRETE AND STRUCTURES

SPECIALS, SUPPLEMENTAL AND STANDARD SPECS, DETAILED DWGS

MATERIAL/ MATERIAL CODE	TESTS	SAMPLE SIZE	SAMPLE/TEST FREQUENCY	FIELD	DISTRICT/ AREA LAB	MDT HQ LAB	NOTES
CLASS SCC CONCRETE 551.03.02.05	AASHTO R 60 SAMPLING FRESH CONCRETE	REFER TO TEST FOR SIZE		SAMPLE			
	MT 117 COMPRESSIVE STRENGTH CYLINDERS OF SCC	1 CU FT (0.03 M ³)	MINIMUM OF 2 SETS PER LOT (200 YD ³ (150 M ³) OR EACH DAY'S POUR WHICHEVER IS LESS)	SAMPLE		TEST	1 SET MAY REPRESENT POURS OF 30 YD ³ (23 M ³) OR LESS [551.03.8(B)(1)(a)]
	AASHTO T 152 AIR CONTENT SCC	1 CU FT (0.03 M ³)	ONE TEST EVERY 24 YD ³ (18 M ³) AND WHEN COMPRESSIVE STRENGTH CYLINDERS ARE MADE	SAMPLE TEST			INCLUDE IN QA
	AASHTO T 347 SLUMP FLOW SCC						TEST EACH LOAD WHEN INCONSISTENT OR FAILING TEST RESULTS ARE ENCOUNTERED
	AASHTO T 345 PASSING ABILITY OF SCC BY J-RING						
	AASHTO T 309 TEMPERATURE OF FRESHLY MIXED CONCRETE						
	AASHTO T 351 VISUAL STABILITY INDEX (VSI)			DETERMINE VSI EVERY TIME A SLUMP FLOW TEST IS CONDUCTED	VISUAL		
	AASHTO T 121 UNIT WEIGHT				SAMPLE TEST		

CONCRETE AND STRUCTURES

SPECIALS, SUPPLEMENTAL AND STANDARD SPECS, DETAILED DWGS

MATERIAL/ MATERIAL CODE	INDEPENDENT ASSURANCE (PROCEDURAL CHECK)			FIELD	DISTRICT/ AREA LAB	MDT HQ LAB	NOTES
CLASS SCC CONCRETE 551.03.02.05	AASHTO R 60 SAMPLING FRESH CONCRETE	USE FIELD TESTED SAMPLE	ONE PER 400 CU YDS (300 M ³) OR A MINIMUM OF ONE PER PROJECT		CHECK	CHECK	PROCEDURAL CHECK MAY BE PERFORMED BY THE DISTRICT/AREA LAB
	AASHTO T 152 AIR CONTENT SCC						
	AASHTO T 347 SLUMP FLOW SCC						
	AASHTO T 345 PASSING ABILITY OF SCC BY J-RING						
	AASHTO T 351 VISUAL STABILITY INDEX						
	MT 117 COMPRESSIVE STRENGTH CYLINDERS OF SCC		ONE SET OF FOUR CYLINDERS PER 400 CU YDS (300 M ³) OR A MINIMUM OF ONE SET PER PROJECT				
	Mix Design			FIELD	DISTRICT/ AREA LAB	MDT HQ LAB	NOTES
CERT/ VISUAL INSPECTION	1 EACH	ONE MIX DESIGN PER BID ITEM	MIX DESIGN		APPROVAL	CERTIFICATION IS THE CONTRACTOR'S MIX DESIGN. SEPARATE MIX DESIGNS NEEDED ONLY WHEN CONCRETE REQUIREMENTS VARY.	

CONCRETE AND STRUCTURES

SPECIALS, SUPPLEMENTAL AND STANDARD SPECS, DETAILED DWGS

MATERIAL/ MATERIAL CODE	TESTS	SAMPLE SIZE	SAMPLE/TEST FREQUENCY	FIELD	DISTRICT/ AREA LAB	MDT HQ LAB	NOTES	
CLASS DECK CONCRETE	AASHTO R 60 SAMPLING FRESH CONCRETE	REFER TO TEST FOR SIZE		SAMPLE				
	MT 101 COMPRESSIVE STRENGTH CYLINDERS	1 CU FT (0.03 M ³)	MINIMUM OF 2 SETS PER LOT (200 YD ³ (150 M ³) OR EACH DAY'S POUR WHICHEVER IS LESS)	SAMPLE		TEST	1 SET MAY REPRESENT POURS OF 30 YD ³ (23 M ³) OR LESS [551.03.8(B)(1)(a)]	
	AASHTO T 358 RESISTIVITY		TEST 3 - 28 DAY COMPRESSIVE STRENGTH CYLINDERS					
	AASHTO T 152 AIR CONTENT	1 CU FT (0.03 M ³)	ONE TEST EVERY 24 YD ³ (18 M ³) AND WHEN COMPRESSIVE STRENGTH CYLINDERS ARE MADE	SAMPLE TEST			INCLUDE IN QA	
	AASHTO T 119 SLUMP						TEST EACH LOAD WHEN INCONSISTENT OR FAILING TEST RESULTS ARE ENCOUNTERED	
	AASHTO T 309 TEMPERATURE OF FRESHLY MIXED CONCRETE							
	AASHTO T 121 UNIT WEIGHT						FOR INFORMATION ONLY	
	551.03.02.06	INDEPENDENT ASSURANCE (PROCEDURAL CHECK)			FIELD	DISTRICT/ AREA LAB	MDT HQ LAB	NOTES
	AASHTO R 60 SAMPLING FRESH CONCRETE	USE FIELD TESTED SAMPLE		ONE PER 400 CU YDS (300 M ³) OR A MINIMUM OF ONE PER PROJECT		CHECK	CHECK	PROCEDURAL CHECK MAY BE PERFORMED BY THE DISTRICT/AREA LAB
	AASHTO T 152 AIR CONTENT							
AASHTO T 119 SLUMP	ONE SET OF FOUR CYLINDERS PER 400 CU YDS (300 M ³) OR A MINIMUM OF ONE SET PER PROJECT							
MT 101 COMPRESSIVE STRENGTH CYLINDERS								
Mix Design				FIELD	DISTRICT/ AREA LAB	MDT HQ LAB	NOTES	
CERT/ VISUAL INSPECTION	1 EACH		ONE MIX DESIGN PER BID ITEM	MIX DESIGN		APPROVAL	CERTIFICATION IS THE CONTRACTOR'S MIX DESIGN. SEPARATE MIX DESIGNS NEEDED ONLY WHEN CONCRETE REQUIREMENTS VARY.	

CONCRETE AND STRUCTURES

SPECIALS, SUPPLEMENTAL AND STANDARD SPECS, DETAILED DWGS

MATERIAL/ MATERIAL CODE	TESTS	SAMPLE SIZE	SAMPLE/TEST FREQUENCY	FIELD	DISTRICT/ AREA LAB	MDT HQ LAB	NOTES	
CLASS OVERLAY-SF CONCRETE	AASHTO R 60 SAMPLING FRESH CONCRETE	REFER TO TEST FOR SIZE		SAMPLE				
	MT 101 COMPRESSIVE STRENGTH CYLINDERS	1 CU FT (0.03 M ³)	MINIMUM OF 2 SETS PER LOT (200 YD ³ (150 M ³) OR EACH DAY'S POUR WHICHEVER IS LESS)	SAMPLE		TEST	1 SET MAY REPRESENT POURS OF 30 YD ³ (23 M ³) OR LESS [551.03.8(B)(1)(a)]	
	AASHTO T 358 RESISTIVITY		TEST 3 - 28 DAY COMPRESSIVE STRENGTH CYLINDERS					
	AASHTO T 152 AIR CONTENT	1 CU FT (0.03 M ³)	ONE TEST FOR THE FIRST LOAD AND THEN ONE TEST EVERY 16 CU YDS (12 M ³) THEREAFTER	SAMPLE TEST			INCLUDE IN QA	
	AASHTO T 119 SLUMP						TEST EACH LOAD WHEN INCONSISTENT OR FAILING TEST RESULTS ARE ENCOUNTERED	
	AASHTO T 309 TEMPERATURE OF FRESHLY MIXED CONCRETE							
	AASHTO T 121 UNIT WEIGHT						FOR INFORMATION ONLY	
	INDEPENDENT ASSURANCE (PROCEDURAL CHECK)				FIELD	DISTRICT/ AREA LAB	MDT HQ LAB	NOTES
	551.03.02.07	AASHTO R 60 SAMPLING FRESH CONCRETE	USE FIELD TESTED SAMPLE	ONE PER 400 CU YDS (300 M ³) OR A MINIMUM OF ONE PER PROJECT		CHECK	CHECK	PROCEDURAL CHECK MAY BE PERFORMED BY THE DISTRICT/AREA LAB
		AASHTO T 152 AIR CONTENT						
AASHTO T 119 SLUMP		ONE SET OF FOUR CYLINDERS PER 400 CU YDS (300 M ³) OR A MINIMUM OF ONE SET PER PROJECT						
MT 101 COMPRESSIVE STRENGTH CYLINDERS								
Mix Design				FIELD	DISTRICT/ AREA LAB	MDT HQ LAB	NOTES	
	CERT/ VISUAL INSPECTION	1 EACH	ONE MIX DESIGN PER BID ITEM	MIX DESIGN		APPROVAL	CERTIFICATION IS THE CONTRACTOR'S MIX DESIGN. SEPARATE MIX DESIGNS NEEDED ONLY WHEN CONCRETE REQUIREMENTS VARY.	

CONCRETE AND STRUCTURES

SPECIALS, SUPPLEMENTAL AND STANDARD SPECS, DETAILED DWGS

MATERIAL/ MATERIAL CODE	TESTS	SAMPLE SIZE	SAMPLE/TEST FREQUENCY	FIELD	DISTRICT/ AREA LAB	MDT HQ LAB	NOTES
CLASS OVERLAY-LM CONCRETE 551.03.02.08	CERT/ VISUAL INSPECTION	1 EACH	ONE PER LOT/BATCH	DATA SHEET			VERIFY LATEX MEETS MDT REQUIREMENTS AND ATTACH APPLICABLE CERT
	AASHTO R 60 SAMPLING FRESH CONCRETE	REFER TO TEST FOR SIZE		SAMPLE			
	MT 101 COMPRESSIVE STRENGTH CYLINDERS	1 CU FT (0.03 M ³)	MINIMUM OF 2 SETS PER LOT (200 YD ³ (150 M ³) OR EACH DAY'S POUR WHICHEVER IS LESS)	SAMPLE		TEST	1 SET MAY REPRESENT POURS OF 30 YD ³ (23 M ³) OR LESS [551.03.8(B)(1)(a)]
	AASHTO T 358 RESISTIVITY						
	AASHTO T 152 AIR CONTENT	1 CU FT (0.03 M ³)	ONE TEST PER EACH MOBILE MIXER	SAMPLE TEST			
	AASHTO T 121 UNIT WEIGHT						

CONCRETE AND STRUCTURES

SPECIALS, SUPPLEMENTAL AND STANDARD SPECS, DETAILED DWGS

MATERIAL/ MATERIAL CODE	TESTS	SAMPLE SIZE	SAMPLE/TEST FREQUENCY	FIELD	DISTRICT/ AREA LAB	MDT HQ LAB	NOTES	
CLASS STRUCTURE CONCRETE 551.03.02.09	AASHTO R 60 SAMPLING FRESH CONCRETE	REFER TO TEST FOR SIZE		SAMPLE				
	MT 101 COMPRESSIVE STRENGTH CYLINDERS	1 CU FT (0.03 M ³)	MINIMUM OF 2 SETS PER LOT (200 YD ³ (150 M ³) OR EACH DAY'S POUR WHICHEVER IS LESS)	SAMPLE		TEST	1 SET MAY REPRESENT POURS OF 30 YD ³ (23 M ³) OR LESS [551.03.8(B)(1)(a)]	
	AASHTO T 358 RESISTIVITY		TEST 3 - 28 DAY COMPRESSIVE STRENGTH CYLINDERS				ONLY REQUIRED WHEN CLASS STRUCTURE IS SPECIFIED BY CONTRACT IN LIEU OF CLASS DECK	
	AASHTO T 152 AIR CONTENT	1 CU FT (0.03 M ³)	ONE TEST EVERY 24 YD ³ (18 M ³) AND WHEN COMPRESSIVE STRENGTH CYLINDERS ARE MADE	SAMPLE TEST			INCLUDE IN QA	
	AASHTO T 119 SLUMP						TEST EACH LOAD WHEN INCONSISTENT OR FAILING TEST RESULTS ARE ENCOUNTERED	
	AASHTO T 309 TEMPERATURE OF FRESHLY MIXED CONCRETE							
	AASHTO T 121 UNIT WEIGHT						FOR INFORMATION ONLY	
	INDEPENDENT ASSURANCE (PROCEDURAL CHECK)				FIELD	DISTRICT/ AREA LAB	MDT HQ LAB	NOTES
	AASHTO R 60 SAMPLING FRESH CONCRETE	USE FIELD TESTED SAMPLE		ONE PER 400 CU YDS (300 M ³) OR A MINIMUM OF ONE PER PROJECT		CHECK	CHECK	PROCEDURAL CHECK MAY BE PERFORMED BY THE DISTRICT/AREA LAB
	AASHTO T 152 AIR CONTENT							
AASHTO T 119 SLUMP								
MT 101 COMPRESSIVE STRENGTH CYLINDERS	ONE SET OF FOUR CYLINDERS PER 400 CU YDS (300 M ³) OR A MINIMUM OF ONE SET PER PROJECT							
Mix Design				FIELD	DISTRICT/ AREA LAB	MDT HQ LAB	NOTES	
CERT/ VISUAL INSPECTION	1 EACH		ONE MIX DESIGN PER BID ITEM	MIX DESIGN		APPROVAL	CERTIFICATION IS THE CONTRACTOR'S MIX DESIGN. SEPARATE MIX DESIGNS NEEDED ONLY WHEN CONCRETE REQUIREMENTS VARY.	

CONCRETE AND STRUCTURES

SPECIALS, SUPPLEMENTAL AND STANDARD SPECS, DETAILED DWGS

MATERIAL/ MATERIAL CODE	TESTS	SAMPLE SIZE	SAMPLE/TEST FREQUENCY	FIELD	DISTRICT/ AREA LAB	MDT HQ LAB	NOTES	
CLASS DRILLED SHAFT CONCRETE 551.03.02.10	AASHTO R 60 SAMPLING FRESH CONCRETE	REFER TO TEST FOR SIZE		SAMPLE				
	MT 101 COMPRESSIVE STRENGTH CYLINDERS	1 CU FT (0.03 M ³)	MINIMUM OF 2 SETS PER LOT (200 YD ³ (150 M ³) OR EACH DAY'S POUR WHICHEVER IS LESS)	SAMPLE		TEST	1 SET MAY REPRESENT POURS OF 30 YD ³ (23 M ³) OR LESS [551.03.8(B)(1)(a)]	
	AASHTO T 152 AIR CONTENT	1 CU FT (0.03 M ³)	ONE TEST EVERY 24 YD ³ (18 M ³) AND WHEN COMPRESSIVE STRENGTH CYLINDERS ARE MADE	SAMPLE TEST			INCLUDE IN QA	
	AASHTO T 119 SLUMP						TEST EACH LOAD WHEN INCONSISTENT OR FAILING TEST RESULTS ARE ENCOUNTERED	
	AASHTO T 309 TEMPERATURE OF FRESHLY MIXED CONCRETE							
	AASHTO T 121 UNIT WEIGHT						FOR INFORMATION ONLY	
	INDEPENDENT ASSURANCE (PROCEDURAL CHECK)				FIELD	DISTRICT/ AREA LAB	MDT HQ LAB	NOTES
	AASHTO R 60 SAMPLING FRESH CONCRETE	USE FIELD TESTED SAMPLE		ONE PER 400 CU YDS (300 M ³) OR A MINIMUM OF ONE PER PROJECT		CHECK	CHECK	PROCEDURAL CHECK MAY BE PERFORMED BY THE DISTRICT/AREA LAB
	AASHTO T 152 AIR CONTENT							
	AASHTO T 119 SLUMP							
MT 101 COMPRESSIVE STRENGTH CYLINDERS	ONE SET OF FOUR CYLINDERS PER 400 CU YDS (300 M ³) OR A MINIMUM OF ONE SET PER PROJECT							
Mix Design				FIELD	DISTRICT/ AREA LAB	MDT HQ LAB	NOTES	
CERT/ VISUAL INSPECTION	1 EACH		ONE MIX DESIGN PER BID ITEM	MIX DESIGN		APPROVAL	CERTIFICATION IS THE CONTRACTOR'S MIX DESIGN. SEPARATE MIX DESIGNS NEEDED ONLY WHEN CONCRETE REQUIREMENTS VARY.	

CONCRETE AND STRUCTURES

SPECIALS, SUPPLEMENTAL AND STANDARD SPECS, DETAILED DWGS

MATERIAL/ MATERIAL CODE	TESTS	SAMPLE SIZE	SAMPLE/TEST FREQUENCY	FIELD	DISTRICT/ AREA LAB	MDT HQ LAB	NOTES
CONTROLLED LOW STRENGTH MATERIAL EXCAV 551.03.02.11	AASHTO R 60 SAMPLING FRESH CONCRETE	REFER TO TEST FOR SIZE		SAMPLE			
	ASTM D4832 PREPARATION AND TESTING OF CLSM	1 CU FT (0.03 M ³)	ONE SET PER PROJECT	SAMPLE		TEST	
NON-EXCAV 551.03.02.12	Mix Design			FIELD	DISTRICT/ AREA LAB	MDT HQ LAB	NOTES
	CERT/ VISUAL INSPECTION	1 EACH	ONE MIX DESIGN PER BID ITEM	MIX DESIGN		APPROVAL	CERTIFICATION IS THE CONTRACTOR'S MIX DESIGN. SEPARATE MIX DESIGNS NEEDED ONLY WHEN CONCRETE REQUIREMENTS VARY.

MATERIAL/ MATERIAL CODE	TESTS	SAMPLE SIZE	SAMPLE/TEST FREQUENCY	FIELD	DISTRICT/ AREA LAB	MDT HQ LAB	NOTES
PRE-PACKAGED CONCRETE 551.03.02.13	CERT/ VISUAL INSPECTION	1 EACH	ONE PER PROJECT, PER TYPE	DATA SHEET			

MATERIAL/ MATERIAL CODE	TESTS	SAMPLE SIZE	SAMPLE/TEST FREQUENCY	FIELD	DISTRICT/ AREA LAB	MDT HQ LAB	NOTES
LEAN CONCRETE 551.03.02.14	CERT/ VISUAL INSPECTION	N/A	ONE PER LOAD	VISUAL			VERIFY ITEM MEETS MDT REQUIREMENTS

CONCRETE AND STRUCTURES

SPECIALS, SUPPLEMENTAL AND STANDARD SPECS, DETAILED DWGS

MATERIAL/ MATERIAL CODE	TESTS	SAMPLE SIZE	SAMPLE/TEST FREQUENCY	FIELD	DISTRICT/ AREA LAB	MDT HQ LAB	NOTES	
SHOTCRETE 551.03.02.15	AASHTO R 60 SAMPLING FRESH CONCRETE	REFER TO TEST FOR SIZE		SAMPLE				
	ASTM C1140 SHOTCRETE PANELS	24"X24"X4" (600 MM X 600 MM X 100 MM) PANEL	TWO SETS OF THREE CORES PER LOT (1 LOT = 100 CU YDS (75 M ³)) (SMALL QUANTITIES TESTED EVERY 25 CY (M ³)) MINIMUM OF ONE TEST/PANEL PER INSTALLATION	SAMPLE		TEST		
	ASTM C1604 OBTAIN & TEST CONCRETE CORES							
	AASHTO T 152 AIR CONTENT	1 CU FT (0.03 M ³)	ONE TEST FOR THE FIRST LOAD AND ONE TEST EVERY 16 CU YDS (12 M ³)	TEST				
	Mix Design				FIELD	DISTRICT/ AREA LAB	MDT HQ LAB	NOTES
	CERT/ VISUAL INSPECTION	1 EACH	ONE MIX DESIGN PER BID ITEM	MIX DESIGN		APPROVAL	CERTIFICATION IS THE CONTRACTOR'S MIX DESIGN. SEPARATE MIX DESIGNS NEEDED ONLY WHEN CONCRETE REQUIREMENTS VARY.	
MATERIAL/ MATERIAL CODE	TESTS	SAMPLE SIZE	SAMPLE/TEST FREQUENCY	FIELD	DISTRICT/ AREA LAB	MDT HQ LAB	NOTES	
EPOXY GROUT 552.02.00.01	CERT/ VISUAL INSPECTION	1 EACH	ONE PER LOT/BATCH	DATA SHEET				

CONCRETE AND STRUCTURES

SPECIALS, SUPPLEMENTAL AND STANDARD SPECS, DETAILED DWGS

MATERIAL/ MATERIAL CODE	TESTS	SAMPLE SIZE	SAMPLE/TEST FREQUENCY	FIELD	DISTRICT/ AREA LAB	MDT HQ LAB	NOTES
PRESTRESSED BEAM 553.01.00.01	CERT/ VISUAL INSPECTION	1 EACH	ONE PER BEAM	CERT OF COMP VISUAL			IF WELDING OCCURS, CERTIFICATE OF COMPLIANCE IS SUBMITTAL OF DOCUMENTATION PER SPECIFICATION 624.03.3
	STEEL CERT CATEGORY 2	1 EACH	ONE PER FORM 406	FORM 406			MANDATORY SUBMITTAL OF DOCUMENTATION PER SPECIFICATION 106.09
	MT 111 PRESTRESSED STRUCTURAL MEMBERS	PER MT 111	ONE PER BEAM			PRE-INSPECTION	

MATERIAL/ MATERIAL CODE	TESTS	SAMPLE SIZE	SAMPLE/TEST FREQUENCY	FIELD	DISTRICT/ AREA LAB	MDT HQ LAB	NOTES
PRECAST CONCRETE PRODUCTS 554.01.00.01	CERT/ VISUAL INSPECTION	1 EACH	ONE PER EACH	CERT OF COMP VISUAL			IF WELDING OCCURS, CERTIFICATE OF COMPLIANCE IS SUBMITTAL OF DOCUMENTATION PER SPECIFICATION 624.03.3
	STEEL CERT CATEGORY 2	1 EACH	ONE PER FORM 406	FORM 406			MANDATORY SUBMITTAL OF DOCUMENTATION PER SPECIFICATION 106.09
	ASTM A416 SEVEN WIRE STRAND	8 FT (3 M)	ONE PER LOT	SAMPLE		TEST	REQUIRED ONLY WHEN MEMBER IS POST-TENSIONED
	MT 110 RCP AND ASSOCIATED ITEMS	N/A				PRE-INSPECTION	
	MT 111 PRESTRESSED STRUCTURAL MEMBERS	PER MT 111	ONE PER DECK SECTION			PRE-INSPECTION	FOR PRESTRESSED ITEMS

CONCRETE AND STRUCTURES

SPECIALS, SUPPLEMENTAL AND STANDARD SPECS, DETAILED DWGS

MATERIAL/ MATERIAL CODE	TESTS	SAMPLE SIZE	SAMPLE/TEST FREQUENCY	FIELD	DISTRICT/ AREA LAB	MDT HQ LAB	NOTES
CATTLE GUARD BASES 554.01.00.02	CERT/ VISUAL INSPECTION	1 EACH	ONE PER EACH	VISUAL			PRE-INSPECTION IS NOT REQUIRED IF ITEM IS PRODUCED AT A CERTIFIED PLANT (QPL)
	STEEL CERT CATEGORY 2	1 EACH	ONE PER FORM 406	FORM 406			
	MT 110 RCP AND ASSOCIATED ITEMS	N/A				PRE-INSPECTION	

MATERIAL/ MATERIAL CODE	TESTS	SAMPLE SIZE	SAMPLE/TEST FREQUENCY	FIELD	DISTRICT/ AREA LAB	MDT HQ LAB	NOTES
CMU/SRW BLOCKS 554.01.00.03	CERT/ VISUAL INSPECTION	1 EACH	ONE PER PROJECT	DATA SHEET			

MATERIAL/ MATERIAL CODE	TESTS	SAMPLE SIZE	SAMPLE/TEST FREQUENCY	FIELD	DISTRICT/ AREA LAB	MDT HQ LAB	NOTES
WATERPROOF MEMBRANE 563.02.00.01	CERT/ VISUAL INSPECTION	1 EACH	ONE PER PROJECT, PER TYPE	DATA SHEET			

MATERIAL/ MATERIAL CODE	TESTS	SAMPLE SIZE	SAMPLE/TEST FREQUENCY	FIELD	DISTRICT/ AREA LAB	MDT HQ LAB	NOTES
EPOXY ADHESIVES 713.14.00.01	CERT/ VISUAL INSPECTION	1 EACH	ONE PER EPOXY TYPE	DATA SHEET			

MDT MATERIALS SAMPLING, TESTING, AND ACCEPTANCE GUIDE

MT 601 (12/31/19)

CONCRETE SEALANT

SPECIALS, SUPPLEMENTAL AND STANDARD SPECS, DETAILED DWGS

MATERIAL/ MATERIAL CODE	TESTS	SAMPLE SIZE	SAMPLE/TEST FREQUENCY	FIELD	DISTRICT/ AREA LAB	MDT HQ LAB	NOTES
LIQUID MEMBRANE- FORMING CONCRETE CURING COMPOUND 717.01.03.01	CERT/ VISUAL INSPECTION	1 EACH	ONE PER PRODUCT	DATA SHEET			ACCEPTANCE ONLY FROM THE QUALIFIED PRODUCTS LIST

MATERIAL/ MATERIAL CODE	TESTS	SAMPLE SIZE	SAMPLE/TEST FREQUENCY	FIELD	DISTRICT/ AREA LAB	MDT HQ LAB	NOTES
CONCRETE CURE AND SEAL COMPOUNDS 717.01.04.01	CERT/ VISUAL INSPECTION	1 EACH	ONE PER PRODUCT	DATA SHEET			ACCEPTANCE ONLY FROM THE QUALIFIED PRODUCTS LIST

MATERIAL/ MATERIAL CODE	TESTS	SAMPLE SIZE	SAMPLE/TEST FREQUENCY	FIELD	DISTRICT/ AREA LAB	MDT HQ LAB	NOTES
SILANE SEALER 717.02.01.01	CERT/ VISUAL INSPECTION	1 EACH	ONE PER PRODUCT	DATA SHEET			ACCEPTANCE ONLY FROM THE QUALIFIED PRODUCTS LIST

MATERIAL/ MATERIAL CODE	TESTS	SAMPLE SIZE	SAMPLE/TEST FREQUENCY	FIELD	DISTRICT/ AREA LAB	MDT HQ LAB	NOTES
HIGH MOLECULAR WEIGHT METHACRYLATE (HMWM) 717.02.02.01	CERT/ VISUAL INSPECTION	1 EACH	ONE PER LOT/BATCH NUMBER	DATA SHEET			ACCEPTANCE ONLY FROM THE QUALIFIED PRODUCTS LIST
	MT 535 BRIDGE DECK CRACK SEALANT IR TEST	2 - 4 OZ (2 - 120 mL) PLASTIC BOTTLES		SAMPLE		TEST	SAMPLE REQUIRED TO BE TAKEN FROM JOB SITE

CONCRETE SEALANT

CONCRETE SEALANT

SPECIALS, SUPPLEMENTAL AND STANDARD SPECS, DETAILED DWGS

MATERIAL/ MATERIAL CODE	TESTS	SAMPLE SIZE	SAMPLE/TEST FREQUENCY	FIELD	DISTRICT/ AREA LAB	MDT HQ LAB	NOTES
EPOXY BRIDGE DECK CRACK SEALANT 717.02.02.02	CERT/ VISUAL INSPECTION	1 EACH	ONE PER LOT/BATCH NUMBER	DATA SHEET			ACCEPTANCE ONLY FROM THE QUALIFIED PRODUCTS LIST

MATERIAL/ MATERIAL CODE	TESTS	SAMPLE SIZE	SAMPLE/TEST FREQUENCY	FIELD	DISTRICT/ AREA LAB	MDT HQ LAB	NOTES
DECK SEALANT SAND 717.02.02.03	CERT/ VISUAL INSPECTION	1 EACH	ONE PER PROJECT	DATA SHEET			CERTIFICATION IS THE GRADATION ON THE CONTAINER

CONCRETE SEALANT

MDT MATERIALS SAMPLING, TESTING, AND ACCEPTANCE GUIDE

MT 601 (12/31/19)

CRACK SEALING

SPECIALS, SUPPLEMENTAL AND STANDARD SPECS, DETAILED DWGS

MATERIAL/ MATERIAL CODE	TESTS	SAMPLE SIZE	SAMPLE/TEST FREQUENCY	FIELD	DISTRICT/ AREA LAB	MDT HQ LAB	NOTES
CRACK SEALANT 403.02.00.01	CERT/ VISUAL INSPECTION	1 EACH	ONE PER LOT/BATCH	DATA SHEET			ACCEPTANCE ONLY FROM THE QUALIFIED PRODUCTS LIST
	ASTM D6690 JOINT AND CRACK SEALANTS	30 LBS	AS REQUESTED	SAMPLE		TEST	

MATERIAL/ MATERIAL CODE	TESTS	SAMPLE SIZE	SAMPLE/TEST FREQUENCY	FIELD	DISTRICT/ AREA LAB	MDT HQ LAB	NOTES
BACKER ROD 403.02.00.02	CERT/ VISUAL INSPECTION	1 EACH	ONE PER PRODUCT	DATA SHEET			ACCEPTANCE ONLY FROM THE QUALIFIED PRODUCTS LIST

CRACK SEALING

EXCAVATION

SPECIALS, SUPPLEMENTAL AND STANDARD SPECS, DETAILED DWGS

MATERIAL/ MATERIAL CODE	TESTS	SAMPLE SIZE	SAMPLE/TEST FREQUENCY	FIELD	DISTRICT/ AREA LAB	MDT HQ LAB	NOTES
EMBANKMENT 203.01.00.01	MT 201 SAMPLING	77 LBS (35 KG)	TEST MATERIAL AS NEEDED FOR SOILS CLASSIFICATION AND/OR PROCTOR	SAMPLE	TEST		SECONDARY TEST INTERIM MEASURE UNTIL A PROCTOR CAN BE PERFORMED
	MT 202 SIEVE ANALYSIS						
	AASHTO T 89 LIQUID LIMIT						
	AASHTO T 90 PLASTIC LIMIT & PLASTICITY INDEX						
	AASHTO M 145 SOIL CLASS						
	MT 229 ZERO AIR VOIDS						
	MT 210 (5.5LB) PROCTOR						
	MT 230 (10LB) PROCTOR						
	AASHTO T 100 SPECIFIC GRAVITY						
	MT 212 COMPACTION AND % MOISTURE (IN-PLACE DENSITY)	N/A	MINIMUM OF ONE TEST PER 2000 CU YDS (1500 M ³) AND A MINIMUM OF ONE TEST PER LIFT	TEST			
MT 218 RELATIVE COMPACTION AND % MOISTURE							
INDEPENDENT ASSURANCE (PROCEDURAL CHECK)				FIELD	DISTRICT/ AREA LAB	MDT HQ LAB	NOTES
MT 212 COMPACTION AND % MOISTURE (IN-PLACE DENSITY)	N/A	ONE PER EACH MILE OR ONE PER EVERY 100,000 CU YDS (75,000 M ³)		CHECK			

EXCAVATION

SPECIALS, SUPPLEMENTAL AND STANDARD SPECS, DETAILED DWGS

MATERIAL/ MATERIAL CODE	TESTS	SAMPLE SIZE	SAMPLE/TEST FREQUENCY	FIELD	DISTRICT/ AREA LAB	MDT HQ LAB	NOTES
SPECIAL BORROW 203.01.00.02	MT 201 SAMPLING	77 LBS (35 KG)	EACH SOURCE OF SPECIAL BORROW IS SUBJECT TO APPROVAL PRIOR TO PLACEMENT (ONE BORROW SOURCE PER 65,000 CU YDS (50,000 M ³)) MINIMUM EIGHT SAMPLES PER BORROW SOURCE 85% OF THE TESTS MUST MEET SOILS CLASSIFICATION OR R-VALUE REQUIREMENT	SAMPLE	TEST		
	MT 202 SIEVE ANALYSIS						
	AASHTO T 89 LIQUID LIMIT						
	AASHTO T 90 PLASTIC LIMIT & PLASTICITY INDEX						
	AASHTO M 145 SOIL CLASS						
	MT 210 (5.5LB) PROCTOR						
	MT 230 (10LB) PROCTOR						
	AASHTO T 190 R-VALUE						
						TEST	TEST REQUIRED IF SPECIFIED IN THE SPECIAL PROVISIONS
		MT 212 COMPACTION AND % MOISTURE (IN-PLACE DENSITY)	N/A	MINIMUM OF ONE TEST PER 2000 CU YDS (1500 M ³) AND A MINIMUM OF ONE TEST PER LIFT	TEST		
	MT 218 RELATIVE COMPACTION AND % MOISTURE						
INDEPENDENT ASSURANCE (PROCEDURAL CHECK)				FIELD	DISTRICT/ AREA LAB	MDT HQ LAB	NOTES
	MT 212 COMPACTION AND % MOISTURE (IN-PLACE DENSITY)	N/A	ONE PER EACH MILE OR ONE PER EVERY 100,000 CU YDS (75,000 M ³)		CHECK		

EXCAVATION

SPECIALS, SUPPLEMENTAL AND STANDARD SPECS, DETAILED DWGS

MATERIAL/ MATERIAL CODE	TESTS	SAMPLE SIZE	SAMPLE/TEST FREQUENCY	FIELD	DISTRICT/ AREA LAB	MDT HQ LAB	NOTES
STEMMING AGGREGATE FOR BLASTING 204.02.00.01	MT 201 SAMPLING	30 LBS (14 KG)	ONE TEST PER SOURCE	SAMPLE			
	MT 202 SIEVE ANALYSIS						
	AASHTO T 90 PLASTIC LIMIT & PLASTICITY INDEX				TEST		
	AASHTO T 335 FRACTURE						

MDT MATERIALS SAMPLING, TESTING, AND ACCEPTANCE GUIDE

MT 601 (12/31/19)

FENCING

SPECIALS, SUPPLEMENTAL AND STANDARD SPECS, DETAILED DWGS

MATERIAL/ MATERIAL CODE	TESTS	SAMPLE SIZE	SAMPLE/TEST FREQUENCY	FIELD	DISTRICT/ AREA LAB	MDT HQ LAB	NOTES
SNOW FENCE MATERIAL 607.02.01.01	CERT/ VISUAL INSPECTION	N/A	ONE PER LOT	VISUAL			VERIFY SEAL NUMBERS CORRESPOND WITH PRE-INSPECTION RECORDS
	MT 404 INSPECTING WOOD PRODUCTS	20 BORINGS	ONE PER CHARGE			PRE-INSPECTION	

MATERIAL/ MATERIAL CODE	TESTS	SAMPLE SIZE	SAMPLE/TEST FREQUENCY	FIELD	DISTRICT/ AREA LAB	MDT HQ LAB	NOTES
CHAIN LINK FABRIC 712.01.02.01	CERT/ VISUAL INSPECTION	1 EACH	ONE PER PRODUCT	DATA SHEET VISUAL			
	STEEL CERT CATEGORY 2	1 EACH	ONE PER FORM 406	FORM 406			MANDATORY SUBMITTAL OF DOCUMENTATION PER SPECIFICATION 106.09

MATERIAL/ MATERIAL CODE	TESTS	SAMPLE SIZE	SAMPLE/TEST FREQUENCY	FIELD	DISTRICT/ AREA LAB	MDT HQ LAB	NOTES
CHAIN LINK STEEL POST 712.01.03.01	CERT/ VISUAL INSPECTION	1 EACH	ONE PER EACH	DATA SHEET VISUAL			
	STEEL CERT CATEGORY 2	1 EACH	ONE PER FORM 406	FORM 406			MANDATORY SUBMITTAL OF DOCUMENTATION PER SPECIFICATION 106.09

MATERIAL/ MATERIAL CODE	TESTS	SAMPLE SIZE	SAMPLE/TEST FREQUENCY	FIELD	DISTRICT/ AREA LAB	MDT HQ LAB	NOTES
CHAIN LINK GATE 712.01.08.01	CERT/ VISUAL INSPECTION	1 EACH	ONE PER EACH	DATA SHEET VISUAL			
	STEEL CERT CATEGORY 2	1 EACH	ONE PER FORM 406	FORM 406			MANDATORY SUBMITTAL OF DOCUMENTATION PER SPECIFICATION 106.09

FENCING

MDT MATERIALS SAMPLING, TESTING, AND ACCEPTANCE GUIDE

MT 601 (12/31/19)

FENCING

SPECIALS, SUPPLEMENTAL AND STANDARD SPECS, DETAILED DWGS

MATERIAL/ MATERIAL CODE	TESTS	SAMPLE SIZE	SAMPLE/TEST FREQUENCY	FIELD	DISTRICT/ AREA LAB	MDT HQ LAB	NOTES
FENCE WIRE 712.02.00.01	CERT/ VISUAL INSPECTION	1 EACH	ONE PER PRODUCT	DATA SHEET VISUAL			
	STEEL CERT CATEGORY 2	1 EACH	ONE PER FORM 406	FORM 406			MANDATORY SUBMITTAL OF DOCUMENTATION PER SPECIFICATION 106.09

MATERIAL/ MATERIAL CODE	TESTS	SAMPLE SIZE	SAMPLE/TEST FREQUENCY	FIELD	DISTRICT/ AREA LAB	MDT HQ LAB	NOTES
STEEL FENCE POST 712.02.07.01	CERT/ VISUAL INSPECTION	1 EACH	ONE PER PRODUCT	DATA SHEET VISUAL			
	STEEL CERT CATEGORY 2	1 EACH	ONE PER FORM 406	FORM 406			MANDATORY SUBMITTAL OF DOCUMENTATION PER SPECIFICATION 106.09

MATERIAL/ MATERIAL CODE	TESTS	SAMPLE SIZE	SAMPLE/TEST FREQUENCY	FIELD	DISTRICT/ AREA LAB	MDT HQ LAB	NOTES
WOOD FENCE POST/BRACE RAIL	CERT/ VISUAL INSPECTION	N/A	ONE PER LOT	VISUAL			VERIFY SEAL NUMBERS CORRESPOND WITH PRE-INSPECTION RECORDS
712.02.08.01	MT 404 INSPECTING WOOD PRODUCTS	20 BORINGS	ONE PER CHARGE			PRE-INSPECTION	

FENCING

MDT MATERIALS SAMPLING, TESTING, AND ACCEPTANCE GUIDE

MT 601 (12/31/19)

FENCING

SPECIALS, SUPPLEMENTAL AND STANDARD SPECS, DETAILED DWGS

MATERIAL/ MATERIAL CODE	TESTS	SAMPLE SIZE	SAMPLE/TEST FREQUENCY	FIELD	DISTRICT/ AREA LAB	MDT HQ LAB	NOTES
METAL GATE	CERT/ VISUAL INSPECTION	1 EACH	ONE PER EACH	DATA SHEET VISUAL			
712.02.09.01	STEEL CERT CATEGORY 2	1 EACH	ONE PER FORM 406	FORM 406			MANDATORY SUBMITTAL OF DOCUMENTATION PER SPECIFICATION 106.09

MATERIAL/ MATERIAL CODE	TESTS	SAMPLE SIZE	SAMPLE/TEST FREQUENCY	FIELD	DISTRICT/ AREA LAB	MDT HQ LAB	NOTES
DEADMAN/ ANCHOR 712.02.12.01	CERT/ VISUAL INSPECTION	1 EACH	ONE PER FABRICATOR	DATA SHEET VISUAL			VERIFY ITEM MEETS MDT REQUIREMENTS AND ATTACH APPLICABLE CERT

FENCING

MDT MATERIALS SAMPLING, TESTING, AND ACCEPTANCE GUIDE

MT 601 (12/31/19)

GEOTEXTILE

SPECIALS, SUPPLEMENTAL AND STANDARD SPECS, DETAILED DWGS

MATERIAL/ MATERIAL CODE	TESTS	SAMPLE SIZE	SAMPLE/TEST FREQUENCY	FIELD	DISTRICT/ AREA LAB	MDT HQ LAB	NOTES
ROLLED EC BLANKET SHORT TERM 713.12.00.01 LONG TERM 713.12.00.02 HIGH PERFORMANCE 713.12.00.03	CERT/ VISUAL INSPECTION	1 EACH	ONE PER LOT OR BATCH	CERT OF COMP OR DATA SHEET			CERTIFICATE OF COMPLIANCE IS REQUIRED FOR ALL EROSION CONTROL THAT CONTAINS STRAW ACCEPTANCE ONLY FROM THE QUALIFIED PRODUCTS LIST

MATERIAL/ MATERIAL CODE	TESTS	SAMPLE SIZE	SAMPLE/TEST FREQUENCY	FIELD	DISTRICT/ AREA LAB	MDT HQ LAB	NOTES
TURF REINFORCEMENT MAT SYNTHETIC FIBER 713.12.00.04 NATURAL FIBER 713.12.00.05	CERT/ VISUAL INSPECTION	1 EACH	ONE PER LOT OR BATCH	CERT OF COMP OR DATA SHEET			CERTIFICATE OF COMPLIANCE IS REQUIRED FOR ALL EROSION CONTROL THAT CONTAINS STRAW ACCEPTANCE ONLY FROM THE QUALIFIED PRODUCTS LIST

MATERIAL/ MATERIAL CODE	TESTS	SAMPLE SIZE	SAMPLE/TEST FREQUENCY	FIELD	DISTRICT/ AREA LAB	MDT HQ LAB	NOTES
GEOCOMPOSITE DRAIN 716.00.00.01	CERT/ VISUAL INSPECTION	1 EACH	ONE PER LOT OR BATCH	CERT OF COMP			SUBMIT SAMPLE OF MATERIAL TO GEOTECHNICAL SECTION FOR REVIEW

MATERIAL/ MATERIAL CODE	TESTS	SAMPLE SIZE	SAMPLE/TEST FREQUENCY	FIELD	DISTRICT/ AREA LAB	MDT HQ LAB	NOTES
GEOSYNTHETIC CLAY LINER 716.00.00.02	CERT/ VISUAL INSPECTION	1 EACH	ONE PER LOT OR BATCH	CERT OF COMP			

GEOTEXTILE

MDT MATERIALS SAMPLING, TESTING, AND ACCEPTANCE GUIDE

MT 601 (12/31/19)

GEOTEXTILE

SPECIALS, SUPPLEMENTAL AND STANDARD SPECS, DETAILED DWGS

MATERIAL/ MATERIAL CODE	TESTS	SAMPLE SIZE	SAMPLE/TEST FREQUENCY	FIELD	DISTRICT/ AREA LAB	MDT HQ LAB	NOTES
GEOMEMBRANE 716.00.00.03	CERT/ VISUAL INSPECTION	1 EACH	ONE PER LOT OR BATCH	CERT OF COMP			SUBMIT SAMPLE OF MATERIAL TO GEOTECHNICAL SECTION FOR REVIEW

MATERIAL/ MATERIAL CODE	TESTS	SAMPLE SIZE	SAMPLE/TEST FREQUENCY	FIELD	DISTRICT/ AREA LAB	MDT HQ LAB	NOTES
SEPARATION GEOTEXTILE MOD SURV 716.02.00.01 HIGH SURV 716.02.00.02	CERT/ VISUAL INSPECTION	1 EACH	ONE PER LOT OR BATCH	CERT OF COMP			QUALIFIED PRODUCTS LIST
	ASTM D4491 PERMITTIVITY	PER MT 421	ONE PER 10,000 SQ YDS (8,000 M ²)	SAMPLE		TEST	SAMPLE REQUIRED ONLY IF NOT ON THE QUALIFIED PRODUCTS LIST
	ASTM D4751 OPENING SIZE						
	ASTM D4355 DETERIORATION						

MATERIAL/ MATERIAL CODE	TESTS	SAMPLE SIZE	SAMPLE/TEST FREQUENCY	FIELD	DISTRICT/ AREA LAB	MDT HQ LAB	NOTES
STABILIZATION GEOTEXTILE 716.03.00.01	CERT/ VISUAL INSPECTION	1 EACH	ONE PER LOT OR BATCH	CERT OF COMP			QUALIFIED PRODUCTS LIST
	ASTM D4491 PERMITTIVITY	PER MT 421	ONE PER 10,000 SQ YDS (8,000 M ²)	SAMPLE		TEST	SAMPLE REQUIRED ONLY IF NOT ON THE QUALIFIED PRODUCTS LIST
	ASTM D4751 OPENING SIZE						
	ASTM D4355 DETERIORATION						

GEOTEXTILE

MDT MATERIALS SAMPLING, TESTING, AND ACCEPTANCE GUIDE

MT 601 (12/31/19)

GEOTEXTILE

SPECIALS, SUPPLEMENTAL AND STANDARD SPECS, DETAILED DWGS

MATERIAL/ MATERIAL CODE	TESTS	SAMPLE SIZE	SAMPLE/TEST FREQUENCY	FIELD	DISTRICT/ AREA LAB	MDT HQ LAB	NOTES
SUBSURFACE DRAIN FILTER - MOD SURV	CERT/ VISUAL INSPECTION	1 EACH	ONE PER LOT OR BATCH	CERT OF COMP			QUALIFIED PRODUCTS LIST
CLASS A 716.04.00.01	ASTM D4491 PERMITTIVITY	PER MT 421	ONE PER 10,000 SQ YDS (8,000 M ²)	SAMPLE		TEST	SAMPLE REQUIRED ONLY IF NOT ON THE QUALIFIED PRODUCTS LIST
CLASS B 716.04.00.02	ASTM D4751 OPENING SIZE						
CLASS C 716.04.00.03	ASTM D4355 DETERIORATION						

MATERIAL/ MATERIAL CODE	TESTS	SAMPLE SIZE	SAMPLE/TEST FREQUENCY	FIELD	DISTRICT/ AREA LAB	MDT HQ LAB	NOTES
SUBSURFACE DRAIN FILTER - HIGH SURV	CERT/ VISUAL INSPECTION	1 EACH	ONE PER LOT OR BATCH	CERT OF COMP			QUALIFIED PRODUCTS LIST
CLASS A 716.04.00.04	ASTM D4491 PERMITTIVITY	PER MT 421	ONE PER 10,000 SQ YDS (8,000 M ²)	SAMPLE		TEST	SAMPLE REQUIRED ONLY IF NOT ON THE QUALIFIED PRODUCTS LIST
CLASS B 716.04.00.05	ASTM D4751 OPENING SIZE						
CLASS C 716.04.00.06	ASTM D4355 DETERIORATION						

GEOTEXTILE

MDT MATERIALS SAMPLING, TESTING, AND ACCEPTANCE GUIDE

MT 601 (12/31/19)

GEOTEXTILE

SPECIALS, SUPPLEMENTAL AND STANDARD SPECS, DETAILED DWGS

MATERIAL/ MATERIAL CODE	TESTS	SAMPLE SIZE	SAMPLE/TEST FREQUENCY	FIELD	DISTRICT/ AREA LAB	MDT HQ LAB	NOTES
PERMANENT EC - MOD SURV	CERT/ VISUAL INSPECTION	1 EACH	ONE PER LOT OR BATCH	CERT OF COMP			QUALIFIED PRODUCTS LIST
CLASS A 716.05.00.01	ASTM D4491 PERMITTIVITY	PER MT 421	ONE PER 10,000 SQ YDS (8,000 M ²)	SAMPLE		TEST	SAMPLE REQUIRED ONLY IF NOT ON THE QUALIFIED PRODUCTS LIST
CLASS B 716.05.00.02	ASTM D4751 OPENING SIZE						
CLASS C 716.05.00.03	ASTM D4355 DETERIORATION						

MATERIAL/ MATERIAL CODE	TESTS	SAMPLE SIZE	SAMPLE/TEST FREQUENCY	FIELD	DISTRICT/ AREA LAB	MDT HQ LAB	NOTES
PERMANENT EC - HIGH SURV	CERT/ VISUAL INSPECTION	1 EACH	ONE PER LOT OR BATCH	CERT OF COMP			QUALIFIED PRODUCTS LIST
CLASS A 716.05.00.04	ASTM D4491 PERMITTIVITY	PER MT 421	ONE PER 10,000 SQ YDS (8,000 M ²)	SAMPLE		TEST	SAMPLE REQUIRED ONLY IF NOT ON THE QUALIFIED PRODUCTS LIST
CLASS B 716.05.00.05	ASTM D4751 OPENING SIZE						
CLASS C 716.05.00.06	ASTM D4355 DETERIORATION						

MATERIAL/ MATERIAL CODE	TESTS	SAMPLE SIZE	SAMPLE/TEST FREQUENCY	FIELD	DISTRICT/ AREA LAB	MDT HQ LAB	NOTES
TEMPORARY SILT FENCE 716.06.00.01	CERT/ VISUAL INSPECTION	1 EACH	ONE PER LOT OR BATCH	DATA SHEET			

MATERIAL/ MATERIAL CODE	TESTS	SAMPLE SIZE	SAMPLE/TEST FREQUENCY	FIELD	DISTRICT/ AREA LAB	MDT HQ LAB	NOTES
GEOGRID 716.07.00.01	CERT/ VISUAL INSPECTION	1 EACH	ONE PER LOT OR BATCH	CERT OF COMP			
	DIRECTLY MEASURE OPENING SIZE WITH CALIPERS	3 FT (1 M) X WIDTH	ONE PER 10,000 SQ YD (8,000 M ²)	SAMPLE		TEST	PER GEOGRID SPECIAL PROVISION

GEOTEXTILE

MDT MATERIALS SAMPLING, TESTING, AND ACCEPTANCE GUIDE

MT 601 (12/31/19)

GUARDRAIL

SPECIALS, SUPPLEMENTAL AND STANDARD SPECS, DETAILED DWGS

MATERIAL/ MATERIAL CODE	TESTS	SAMPLE SIZE	SAMPLE/TEST FREQUENCY	FIELD	DISTRICT/ AREA LAB	MDT HQ LAB	NOTES
METAL BEAM GUARDRAIL	CERT/ VISUAL INSPECTION	1 EACH	ONE PER EACH	DATA SHEET VISUAL			
705.01.01.01	STEEL CERT CATEGORY 1	1 EACH	ONE PER FORM 406	FORM 406			MANDATORY SUBMITTAL OF DOCUMENTATION FOR EACH HEAT #

MATERIAL/ MATERIAL CODE	TESTS	SAMPLE SIZE	SAMPLE/TEST FREQUENCY	FIELD	DISTRICT/ AREA LAB	MDT HQ LAB	NOTES
BOX BEAM GUARDRAIL	CERT/ VISUAL INSPECTION	1 EACH	ONE PER EACH	DATA SHEET VISUAL			
705.01.01.02	STEEL CERT CATEGORY 1	1 EACH	ONE PER FORM 406	FORM 406			MANDATORY SUBMITTAL OF DOCUMENTATION FOR EACH HEAT #

MATERIAL/ MATERIAL CODE	TESTS	SAMPLE SIZE	SAMPLE/TEST FREQUENCY	FIELD	DISTRICT/ AREA LAB	MDT HQ LAB	NOTES
CABLE GUARDRAIL/ WIRE ROPE	CERT/ VISUAL INSPECTION	1 EACH	ONE PER EACH	DATA SHEET VISUAL			
705.01.01.03	STEEL CERT CATEGORY 2	1 EACH	ONE PER FORM 406	FORM 406			MANDATORY SUBMITTAL OF DOCUMENTATION PER SPECIFICATION 106.09

MATERIAL/ MATERIAL CODE	TESTS	SAMPLE SIZE	SAMPLE/TEST FREQUENCY	FIELD	DISTRICT/ AREA LAB	MDT HQ LAB	NOTES
MISCELLANEOUS GUARDRAIL	CERT/ VISUAL INSPECTION	1 EACH	ONE PER ITEM	DATA SHEET			
705.01.01.05	STEEL CERT CATEGORY 2	1 EACH	ONE PER FORM 406	FORM 406			MANDATORY SUBMITTAL OF DOCUMENTATION PER SPECIFICATION 106.09

GUARDRAIL

MDT MATERIALS SAMPLING, TESTING, AND ACCEPTANCE GUIDE

MT 601 (12/31/19)

GUARDRAIL

SPECIALS, SUPPLEMENTAL AND STANDARD SPECS, DETAILED DWGS

MATERIAL/ MATERIAL CODE	TESTS	SAMPLE SIZE	SAMPLE/TEST FREQUENCY	FIELD	DISTRICT/ AREA LAB	MDT HQ LAB	NOTES
WOOD GUARDRAIL POST/BLOCKOUT	CERT/ VISUAL INSPECTION	N/A	ONE PER LOT OR BATCH	VISUAL			VERIFY SEAL NUMBERS CORRESPOND WITH PRE-INSPECTION RECORDS
705.01.02.01	MT 404 INSPECTING WOOD PRODUCTS	20 BORINGS	ONE PER CHARGE			PRE-INSPECTION	

MATERIAL/ MATERIAL CODE	TESTS	SAMPLE SIZE	SAMPLE/TEST FREQUENCY	FIELD	DISTRICT/ AREA LAB	MDT HQ LAB	NOTES
NON-WOOD BLOCKOUT	CERT/ VISUAL INSPECTION	1 EACH	ONE PER LOT OR BATCH	CERT OF COMP VISUAL			
705.01.02.02							

MATERIAL/ MATERIAL CODE	TESTS	SAMPLE SIZE	SAMPLE/TEST FREQUENCY	FIELD	DISTRICT/ AREA LAB	MDT HQ LAB	NOTES
STEEL GUARDRAIL POST	CERT/ VISUAL INSPECTION	1 EACH	ONE PER EACH	CERT OF COMP VISUAL			
705.01.05.01	STEEL CERT CATEGORY 2	1 EACH	ONE PER FORM 406	FORM 406			MANDATORY SUBMITTAL OF DOCUMENTATION PER SPECIFICATION 106.09

MATERIAL/ MATERIAL CODE	TESTS	SAMPLE SIZE	SAMPLE/TEST FREQUENCY	FIELD	DISTRICT/ AREA LAB	MDT HQ LAB	NOTES
W-BEAM TERMINAL SECTION	CERT/ VISUAL INSPECTION	1 EACH	ONE PER PROJECT	DATA SHEET			ACCEPTANCE ONLY FROM THE QUALIFIED PRODUCTS LIST
606.02.00.01	STEEL CERT CATEGORY 2	1 EACH	ONE PER FORM 406	FORM 406			MANDATORY SUBMITTAL OF DOCUMENTATION PER SPECIFICATION 106.09

GUARDRAIL

MDT MATERIALS SAMPLING, TESTING, AND ACCEPTANCE GUIDE
 SPECIALS, SUPPLEMENTAL AND STANDARD SPECS, DETAILED DWGS

MT 601 (12/31/19)

JOINT MATERIAL

MATERIAL/ MATERIAL CODE	TESTS	SAMPLE SIZE	SAMPLE/TEST FREQUENCY	FIELD	DISTRICT/ AREA LAB	MDT HQ LAB	NOTES
EXPANSION JOINT FILLERS - CORK 707.01.00.01	CERT/ VISUAL INSPECTION	1 EACH	ONE PER PRODUCT	DATA SHEET			ACCEPTANCE ONLY FROM THE QUALIFIED PRODUCTS LIST
JOINT SEALING MATERIAL 707.01.01.01	CERT/ VISUAL INSPECTION	1 EACH	ONE PER PRODUCT	DATA SHEET			ACCEPTANCE ONLY FROM THE QUALIFIED PRODUCTS LIST
EXPANSION JOINT SYSTEM 707.01.02.01	CERT/ VISUAL INSPECTION	1 EACH	ONE PER PRODUCT	DATA SHEET OR CERT OF COMP			IF WELDING OCCURS, CERTIFICATE OF COMPLIANCE IS SUBMITTAL OF DOCUMENTATION PER SPECIFICATION 624.03.3
	STEEL CERT CATEGORY 2	1 EACH	ONE PER FORM 406	FORM 406			MANDATORY SUBMITTAL OF DOCUMENTATION PER SPECIFICATION 106.09
SILICONE JOINT SEAL 707.01.02.02	CERT/ VISUAL INSPECTION	1 EACH	ONE PER PRODUCT	DATA SHEET			
FABRIC REINFORCED NEOPRENE JOINT SEAL 707.01.02.03	CERT/ VISUAL INSPECTION	1 EACH	ONE PER PRODUCT	DATA SHEET			

JOINT MATERIAL

MDT MATERIALS SAMPLING, TESTING, AND ACCEPTANCE GUIDE

MT 601 (12/31/19)

JOINT MATERIAL

SPECIALS, SUPPLEMENTAL AND STANDARD SPECS, DETAILED DWGS

MATERIAL/ MATERIAL CODE	TESTS	SAMPLE SIZE	SAMPLE/TEST FREQUENCY	FIELD	DISTRICT/ AREA LAB	MDT HQ LAB	NOTES
EXPANSION JOINT ASPHALT PLUG 707.01.02.04	CERT/ VISUAL INSPECTION	1 EACH	ONE PER PRODUCT	DATA SHEET			

MATERIAL/ MATERIAL CODE	TESTS	SAMPLE SIZE	SAMPLE/TEST FREQUENCY	FIELD	DISTRICT/ AREA LAB	MDT HQ LAB	NOTES
PREFORMED EXPANSION JOINT FILLER 707.01.03.01	CERT/ VISUAL INSPECTION	1 EACH	ONE PER PRODUCT	DATA SHEET			

MATERIAL/ MATERIAL CODE	TESTS	SAMPLE SIZE	SAMPLE/TEST FREQUENCY	FIELD	DISTRICT/ AREA LAB	MDT HQ LAB	NOTES
RUBBER GASKET 707.02.01.01	CERT/ VISUAL INSPECTION	1 EACH	ONE PER PRODUCT	DATA SHEET			

MATERIAL/ MATERIAL CODE	TESTS	SAMPLE SIZE	SAMPLE/TEST FREQUENCY	FIELD	DISTRICT/ AREA LAB	MDT HQ LAB	NOTES
FLEXIBLE JOINT SEALER 707.02.02.01	CERT/ VISUAL INSPECTION	1 EACH	ONE PER PRODUCT	DATA SHEET			

JOINT MATERIAL

LIGHTING, SIGNALS & COMMUNICATION

SPECIALS, SUPPLEMENTAL AND STANDARD SPECS, DETAILED DWGS

MATERIAL/ MATERIAL CODE	TESTS	SAMPLE SIZE	SAMPLE/TEST FREQUENCY	FIELD	DISTRICT/ AREA LAB	MDT HQ LAB	NOTES
VARIABLE MESSAGE SIGN	ELECTRICAL ITEM CHECKLIST	1 EACH	ONE PER ITEM	DATA SHEET VISUAL			VERIFY ITEM SUPPLIED MATCHES APPROVED SUBMITTAL
ANTENNA	ELECTRICAL ITEM CHECKLIST	1 EACH	ONE PER ITEM	DATA SHEET			VERIFY ITEM SUPPLIED MATCHES APPROVED SUBMITTAL
ELECTRICAL SUBMITTAL 703.00.00.00	ELECTRICAL ITEM CHECKLIST	1 EACH	ONE PER PROJECT	DATA SHEET			SEE INDIVIDUAL MATERIALS FOR STEEL REQUIREMENTS
PVC CONDUIT	ELECTRICAL ITEM CHECKLIST	1 EACH	ONE PER SIZE	DATA SHEET			QUALIFIED PRODUCTS LIST VERIFY ITEM SUPPLIED MATCHES APPROVED SUBMITTAL
HDPE CONDUIT	ELECTRICAL ITEM CHECKLIST	1 EACH	ONE PER SIZE	DATA SHEET			QUALIFIED PRODUCTS LIST VERIFY ITEM SUPPLIED MATCHES APPROVED SUBMITTAL
STEEL CONDUIT	ELECTRICAL ITEM CHECKLIST	N/A	ONE PER LOT	VISUAL			QUALIFIED PRODUCTS LIST VERIFY ITEM SUPPLIED MATCHES APPROVED SUBMITTAL
	STEEL CERT CATEGORY 2	1 EACH	ONE PER FORM 406	FORM 406			MANDATORY SUBMITTAL OF DOCUMENTATION PER SPECIFICATION 106.09

LIGHTING, SIGNALS & COMMUNICATION

SPECIALS, SUPPLEMENTAL AND STANDARD SPECS, DETAILED DWGS

MATERIAL/ MATERIAL CODE	TESTS	SAMPLE SIZE	SAMPLE/TEST FREQUENCY	FIELD	DISTRICT/ AREA LAB	MDT HQ LAB	NOTES
PULL BOXES	ELECTRICAL ITEM CHECKLIST	1 EACH	ONE PER LOT/BATCH	DATA SHEET			VERIFY ITEM SUPPLIED MATCHES APPROVED SUBMITTAL
	STEEL CERT CATEGORY 2	1 EACH	ONE PER FORM 406	FORM 406			MANDATORY SUBMITTAL OF DOCUMENTATION PER SPECIFICATION 106.09

MATERIAL/ MATERIAL CODE	TESTS	SAMPLE SIZE	SAMPLE/TEST FREQUENCY	FIELD	DISTRICT/ AREA LAB	MDT HQ LAB	NOTES
SIGNAL STANDARDS TYPE 2/3	ELECTRICAL ITEM CHECKLIST	1 EACH	ONE PER ITEM/LOT	DATA SHEET			VERIFY ITEM SUPPLIED MATCHES APPROVED SUBMITTAL
	STEEL CERT CATEGORY 2	1 EACH	ONE PER FORM 406	FORM 406			MANDATORY SUBMITTAL OF DOCUMENTATION PER SPECIFICATION 106.09 NO CERTIFICATION IS REQUIRED IF THIS ITEM IS SUPPLIED BY MDT

MATERIAL/ MATERIAL CODE	TESTS	SAMPLE SIZE	SAMPLE/TEST FREQUENCY	FIELD	DISTRICT/ AREA LAB	MDT HQ LAB	NOTES
LUMINAIRE STANDARD TYPE 10	ELECTRICAL ITEM CHECKLIST	1 EACH	ONE PER ITEM/LOT	DATA SHEET			VERIFY ITEM SUPPLIED MATCHES APPROVED SUBMITTAL
	STEEL CERT CATEGORY 2	1 EACH	ONE PER FORM 406	FORM 406			MANDATORY SUBMITTAL OF DOCUMENTATION PER SPECIFICATION 106.09 NO CERTIFICATION IS REQUIRED IF THIS ITEM IS SUPPLIED BY MDT

MATERIAL/ MATERIAL CODE	TESTS	SAMPLE SIZE	SAMPLE/TEST FREQUENCY	FIELD	DISTRICT/ AREA LAB	MDT HQ LAB	NOTES
SIGNAL STANDARDS TYPE 1	ELECTRICAL ITEM CHECKLIST	1 EACH	ONE PER ITEM/LOT	DATA SHEET			VERIFY ITEM SUPPLIED MATCHES APPROVED SUBMITTAL
	STEEL CERT CATEGORY 2	1 EACH	ONE PER FORM 406	FORM 406			MANDATORY SUBMITTAL OF DOCUMENTATION PER SPECIFICATION 106.09 NO CERTIFICATION IS REQUIRED IF THIS ITEM IS SUPPLIED BY MDT

LIGHTING, SIGNALS & COMMUNICATION

SPECIALS, SUPPLEMENTAL AND STANDARD SPECS, DETAILED DWGS

MATERIAL/ MATERIAL CODE	TESTS	SAMPLE SIZE	SAMPLE/TEST FREQUENCY	FIELD	DISTRICT/ AREA LAB	MDT HQ LAB	NOTES
CONDUCTOR	ELECTRICAL ITEM CHECKLIST	1 EACH	ONE PER LOT	DATA SHEET			VERIFY ITEM SUPPLIED MATCHES APPROVED SUBMITTAL

MATERIAL/ MATERIAL CODE	TESTS	SAMPLE SIZE	SAMPLE/TEST FREQUENCY	FIELD	DISTRICT/ AREA LAB	MDT HQ LAB	NOTES
CABLE	ELECTRICAL ITEM CHECKLIST	1 EACH	ONE PER LOT	DATA SHEET			VERIFY ITEM SUPPLIED MATCHES APPROVED SUBMITTAL

MATERIAL/ MATERIAL CODE	TESTS	SAMPLE SIZE	SAMPLE/TEST FREQUENCY	FIELD	DISTRICT/ AREA LAB	MDT HQ LAB	NOTES
SERVICE & CONTROL ASSEMBLY	ELECTRICAL ITEM CHECKLIST	1 EACH	ONE PER ITEM	DATA SHEET			VERIFY ITEM SUPPLIED MATCHES APPROVED SUBMITTAL

MATERIAL/ MATERIAL CODE	TESTS	SAMPLE SIZE	SAMPLE/TEST FREQUENCY	FIELD	DISTRICT/ AREA LAB	MDT HQ LAB	NOTES
TRAFFIC SIGNAL CABINET	ELECTRICAL ITEM CHECKLIST	1 EACH	ONE PER ITEM	DATA SHEET			VERIFY ITEM SUPPLIED MATCHES APPROVED SUBMITTAL

MATERIAL/ MATERIAL CODE	TESTS	SAMPLE SIZE	SAMPLE/TEST FREQUENCY	FIELD	DISTRICT/ AREA LAB	MDT HQ LAB	NOTES
TRAFFIC SIGNAL INDICATION	ELECTRICAL ITEM CHECKLIST	1 EACH	ONE PER ITEM	DATA SHEET			QUALIFIED PRODUCTS LIST VERIFY ITEM SUPPLIED MATCHES APPROVED SUBMITTAL

MATERIAL/ MATERIAL CODE	TESTS	SAMPLE SIZE	SAMPLE/TEST FREQUENCY	FIELD	DISTRICT/ AREA LAB	MDT HQ LAB	NOTES
LED TRAFFIC SIGNAL	ELECTRICAL ITEM CHECKLIST	1 EACH	ONE PER ITEM	DATA SHEET			QUALIFIED PRODUCTS LIST VERIFY ITEM SUPPLIED MATCHES APPROVED SUBMITTAL

MATERIAL/ MATERIAL CODE	TESTS	SAMPLE SIZE	SAMPLE/TEST FREQUENCY	FIELD	DISTRICT/ AREA LAB	MDT HQ LAB	NOTES
PEDESTRIAN SIGNAL INDICATION	ELECTRICAL ITEM CHECKLIST	1 EACH	ONE PER ITEM	DATA SHEET			QUALIFIED PRODUCTS LIST VERIFY ITEM SUPPLIED MATCHES APPROVED SUBMITTAL

LIGHTING, SIGNALS & COMMUNICATION

SPECIALS, SUPPLEMENTAL AND STANDARD SPECS, DETAILED DWGS

MATERIAL/ MATERIAL CODE	TESTS	SAMPLE SIZE	SAMPLE/TEST FREQUENCY	FIELD	DISTRICT/ AREA LAB	MDT HQ LAB	NOTES
DETECTOR LOOP	ELECTRICAL ITEM CHECKLIST	1 EACH	ONE PER ITEM	DATA SHEET			VERIFY ITEM SUPPLIED MATCHES APPROVED SUBMITTAL
PEDESTRIAN PUSH BUTTONS	ELECTRICAL ITEM CHECKLIST	1 EACH	ONE PER ITEM	DATA SHEET			VERIFY ITEM SUPPLIED MATCHES APPROVED SUBMITTAL
LUMINAIRE ASSEMBLY	ELECTRICAL ITEM CHECKLIST	1 EACH	ONE PER ITEM	DATA SHEET			VERIFY ITEM SUPPLIED MATCHES APPROVED SUBMITTAL
EMERGENCY VEHICLE PREEMPTION	ELECTRICAL ITEM CHECKLIST	1 EACH	ONE PER ITEM	DATA SHEET			VERIFY ITEM SUPPLIED MATCHES APPROVED SUBMITTAL
CLASS 4 TREATED WOOD POLES 703.14.00.01	CERT/ VISUAL INSPECTION	N/A	ONE PER CHARGE	VISUAL			VERIFY SEAL NUMBERS CORRESPOND WITH PRE-INSPECTION RECORDS
	MT 404 INSPECTING WOOD PRODUCTS	20 BORINGS	ONE PER CHARGE		PRE-INSPECTION		
GUYS & ANCHORS	ELECTRICAL ITEM CHECKLIST	1 EACH	ONE PER ITEM	DATA SHEET			VERIFY ITEM SUPPLIED MATCHES APPROVED SUBMITTAL

MDT MATERIALS SAMPLING, TESTING, AND ACCEPTANCE GUIDE

MT 601 (12/31/19)

MAINTENANCE

SPECIALS, SUPPLEMENTAL AND STANDARD SPECS, DETAILED DWGS

MATERIAL/ MATERIAL CODE	TESTS	SAMPLE SIZE	SAMPLE/TEST FREQUENCY	FIELD MAINT	DISTRICT/ AREA LAB	MDT HQ LAB	NOTES
SALT 8A-R (ROAD SALT) MT 1.1	CERT/ VISUAL INSPECTION	N/A	ONE PER TRUCK LOAD	VISUAL DATA SHEET			VISUALLY EVALUATE FOR CONTAMINATION
	*PNS METHOD 13 SALT GRADATION	AIR TIGHT CONTAINER (1 GAL SEALABLE BAG)	AS REQUESTED	SAMPLE	TEST		*GRADATION - MUST BE HAND SHAKEN
	MT 526 MOISTURE OF PNS SALT		ONE PER TRUCK LOAD - TEST EACH SAMPLE - EXCEPT MISSOULA AND KALISPELL TEST EACH 5TH SAMPLE - IN CASE OF A FAILURE, TEST EACH SAMPLE				TESTING OF MOISTURE CONTENT

MATERIAL/ MATERIAL CODE	TESTS	SAMPLE SIZE	SAMPLE/TEST FREQUENCY	FIELD MAINT	DISTRICT/ AREA LAB	MDT HQ LAB	NOTES
SALT 8A-B (BRINE SALT) MT 1.2	CERT/ VISUAL INSPECTION	N/A	ONE PER TRUCK LOAD	VISUAL DATA SHEET			VISUALLY EVALUATE FOR CONTAMINATION
	*PNS METHOD 13 SALT GRADATION	AIR TIGHT CONTAINER (1 GAL SEALABLE BAG)	AS REQUESTED	SAMPLE	TEST		*GRADATION - MUST BE HAND SHAKEN
	MT 526 MOISTURE OF PNS SALT						TESTING OF MOISTURE CONTENT

MDT MATERIALS SAMPLING, TESTING, AND ACCEPTANCE GUIDE

MT 601 (12/31/19)

MAINTENANCE

SPECIALS, SUPPLEMENTAL AND STANDARD SPECS, DETAILED DWGS

MATERIAL/ MATERIAL CODE	TESTS	SAMPLE SIZE	SAMPLE/TEST FREQUENCY	FIELD MAINT	DISTRICT/ AREA LAB	MDT HQ LAB	NOTES
SALT 8B (WET SALT) MT 1.3	CERT/ VISUAL INSPECTION	N/A	ONE PER TRUCK LOAD	VISUAL DATA SHEET			VISUALLY EVALUATE FOR CONTAMINATION
	*PNS METHOD 13 SALT GRADATION	AIR TIGHT CONTAINER (1 GAL SEALABLE BAG)	AS REQUESTED	SAMPLE	TEST		*GRADATION - MUST BE HAND SHAKEN
	MT 526 MOISTURE OF PNS SALT		ONE PER TRUCK LOAD - TEST EACH SAMPLE EXCEPT MISSOULA AND KALISPELL TEST EACH 5TH SAMPLE IN CASE OF A FAILURE, TEST EACH SAMPLE				TESTING OF MOISTURE CONTENT

MATERIAL/ MATERIAL CODE	TESTS	SAMPLE SIZE	SAMPLE/TEST FREQUENCY	FIELD MAINT	DISTRICT/ AREA LAB	MDT HQ LAB	NOTES
SALT BRINE - NaCl MT 2	MT 501 pH INSOLUBLE MTRL C.R. TOTAL SETTLEABLE SOLIDS PERCENT PASSING #10 SIEVE	1 GALLON (4 LITERS)	ONE SAMPLE FOR EVERY 100,000 GALLONS	SAMPLE		TEST	C.R. = CORROSION RATE
	MT 502 CHEMICAL ANALYSIS						
	MT 504 CYANIDE						

MAINTENANCE

MDT MATERIALS SAMPLING, TESTING, AND ACCEPTANCE GUIDE

MT 601 (12/31/19)

MAINTENANCE

SPECIALS, SUPPLEMENTAL AND STANDARD SPECS, DETAILED DWGS

MATERIAL/ MATERIAL CODE	TESTS	SAMPLE SIZE	SAMPLE/TEST FREQUENCY	FIELD MAINT	DISTRICT/ AREA LAB	MDT HQ LAB	NOTES
DE-ICER MgCl ₂ MT 3.1	CERT/ VISUAL INSPECTION	1 EACH	ONE PER TRUCK LOAD	DATA SHEET			
	MT 408 SAMPLING LIQUID DEICING MATERIAL	1 GALLON	ONE SAMPLE FOR EVERY 100,000 GALLONS	SAMPLE			
	MT 501 pH INSOLUBLE MTRL C.R. TOTAL SETTLEABLE SOLIDS PERCENT PASSING #10 SIFVE					TEST	C.R. = CORROSION RATE
	MT 502 CHEMICAL ANALYSIS						
	MT 504 CYANIDE						

MDT MATERIALS SAMPLING, TESTING, AND ACCEPTANCE GUIDE

MT 601 (12/31/19)

MAINTENANCE

SPECIALS, SUPPLEMENTAL AND STANDARD SPECS, DETAILED DWGS

MATERIAL/ MATERIAL CODE	TESTS	SAMPLE SIZE	SAMPLE/TEST FREQUENCY	FIELD MAINT	DISTRICT/ AREA LAB	MDT HQ LAB	NOTES
DE-ICER CaCl ₂ MT 3.2	CERT/ VISUAL INSPECTION	1 EACH	ONE PER TRUCK LOAD	DATA SHEET			
	MT 408 SAMPLING LIQUID DEICING MATERIAL	1 GALLON	ONE SAMPLE FOR EVERY 100,000 GALLONS	SAMPLE			
	MT 501 pH INSOLUBLE MTRL C.R. TOTAL SETTLEABLE SOLIDS PERCENT PASSING #10 SIEVE					TEST	C.R. = CORROSION RATE
	MT 502 CHEMICAL ANALYSIS						
	MT 504 CYANIDE						

MDT MATERIALS SAMPLING, TESTING, AND ACCEPTANCE GUIDE

MAINTENANCE

SPECIALS, SUPPLEMENTAL AND STANDARD SPECS, DETAILED DWGS

MATERIAL/ MATERIAL CODE	TESTS	SAMPLE SIZE	SAMPLE/TEST FREQUENCY	FIELD MAINT	DISTRICT/ AREA LAB	MDT HQ LAB	NOTES
DE-ICER KCH ₃ COO MT 3.3	CERT/ VISUAL INSPECTION	1 EACH	ONE PER TRUCK LOAD	DATA SHEET			
	MT 408 SAMPLING LIQUID DEICING MATERIAL	1 GALLON	ONE SAMPLE PER CONTRACT AND AS REQUESTED	SAMPLE			
	MT 501 pH INSOLUBLE MTRL C.R. TOTAL SETTLEABLE SOLIDS PERCENT PASSING #10 SIEVE					TEST	C.R. = CORROSION RATE
	MT 502 CHEMICAL ANALYSIS						
	MT 504 CYANIDE						

MATERIAL/ MATERIAL CODE	TESTS	SAMPLE SIZE	SAMPLE/TEST FREQUENCY	FIELD MAINT	DISTRICT/ AREA LAB	MDT HQ LAB	NOTES
3/8" SANDING MATERIAL MT 4.1	CERT/ VISUAL INSPECTION	1 EACH		DATA SHEET			
	MT 201 SAMPLING	30 LBS	ONE PER 2,000 TONS	SAMPLE			
	MT 202 SIEVE ANALYSIS					TEST	
	AASHTO T 19 UNIT WEIGHT						

MAINTENANCE

MDT MATERIALS SAMPLING, TESTING, AND ACCEPTANCE GUIDE

MT 601 (12/31/19)

MAINTENANCE

SPECIALS, SUPPLEMENTAL AND STANDARD SPECS, DETAILED DWGS

MATERIAL/ MATERIAL CODE	TESTS	SAMPLE SIZE	SAMPLE/TEST FREQUENCY	FIELD MAINT	DISTRICT/ AREA LAB	MDT HQ LAB	NOTES
5/16" SANDING MATERIAL MT 4.2	CERT/ VISUAL INSPECTION	1 EACH	ONE PER 2,000 TONS	DATA SHEET	TEST		
	MT 201 SAMPLING	30 LBS		SAMPLE			
	MT 202 SIEVE ANALYSIS						
	AASHTO T 19 UNIT WEIGHT						

MATERIAL/ MATERIAL CODE	TESTS	SAMPLE SIZE	SAMPLE/TEST FREQUENCY	FIELD MAINT	DISTRICT/ AREA LAB	MDT HQ LAB	NOTES
ENGINE OIL ANALYSIS	CERT/ VISUAL INSPECTION	1 EACH	YEARLY/AS NEEDED	DATA SHEET		TEST	
MT 5	MT 520 ENGINE OIL ANALYSIS	50 mL		SAMPLE			

MDT MATERIALS SAMPLING, TESTING, AND ACCEPTANCE GUIDE

MT 601 (12/31/19)

MAINTENANCE

SPECIALS, SUPPLEMENTAL AND STANDARD SPECS, DETAILED DWGS

MATERIAL/ MATERIAL CODE	TESTS	SAMPLE SIZE	SAMPLE/TEST FREQUENCY	FIELD MAINT	DISTRICT/ AREA LAB	MDT HQ LAB	NOTES
CORROSION INHIBITOR MT 6	CERT/ VISUAL INSPECTION	1 EACH	ONE PER TRUCK LOAD	DATA SHEET			
	MT 408 SAMPLING LIQUID DEICING MATERIAL	1 GALLON	ONE SAMPLE FOR EVERY 100,000 GALLONS	SAMPLE			
	MT 501 pH INSOLUBLE MTRL C.R. TOTAL SETTLEABLE SOLIDS PERCENT PASSING #10 SIEVE					TEST	C.R. = CORROSION RATE
	MT 502 CHEMICAL ANALYSIS						
	MT 504 CYANIDE						

MATERIAL/ MATERIAL CODE	TESTS	SAMPLE SIZE	SAMPLE/TEST FREQUENCY	FIELD MAINT	DISTRICT/ AREA LAB	MDT HQ LAB	NOTES
COLD MIX ASPHALT PATCHING MATERIAL MT 7	CERT/ VISUAL INSPECTION	1 EACH	ONE PER CONTRACT	DATA SHEET			
	AASHTO T 335 FRACTURE	30 LBS		SAMPLE	TEST		
	MT 322 PERCENT ADHESION					TEST	

MAINTENANCE

MDT MATERIALS SAMPLING, TESTING, AND ACCEPTANCE GUIDE

MT 601 (12/31/19)

MISCELLANEOUS

SPECIALS, SUPPLEMENTAL AND STANDARD SPECS, DETAILED DWGS

MATERIAL/ MATERIAL CODE	TESTS	SAMPLE SIZE	SAMPLE/TEST FREQUENCY	FIELD	DISTRICT/ AREA LAB	MDT HQ LAB	NOTES
DETECTABLE WARNING DEVICES 608.02.00.01	CERT/ VISUAL INSPECTION	1 EACH	ONE PER PRODUCT	DATA SHEET			ACCEPTANCE ONLY FROM THE QUALIFIED PRODUCTS LIST
	STEEL CERT CATEGORY 2	1 EACH	ONE PER FORM 406	FORM 406			MANDATORY SUBMITTAL OF DOCUMENTATION PER SPECIFICATION 106.09

MATERIAL/ MATERIAL CODE	TESTS	SAMPLE SIZE	SAMPLE/TEST FREQUENCY	FIELD	DISTRICT/ AREA LAB	MDT HQ LAB	NOTES
CATTLE GUARD GRATE 611.02.04.01	CERT/ VISUAL INSPECTION	1 EACH	ONE PER PRODUCT	CERT OF COMP			IF WELDING OCCURS, CERTIFICATE OF COMPLIANCE IS SUBMITTAL OF DOCUMENTATION PER SPECIFICATION 624.03.3
	STEEL CERT CATEGORY 2	1 EACH	ONE PER FORM 406	FORM 406			MANDATORY SUBMITTAL OF DOCUMENTATION PER SPECIFICATION 106.09

MATERIAL/ MATERIAL CODE	TESTS	SAMPLE SIZE	SAMPLE/TEST FREQUENCY	FIELD	DISTRICT/ AREA LAB	MDT HQ LAB	NOTES
MAIL BOX 623.02.00.01	CERT/ VISUAL INSPECTION	1 EACH	ONE PER PRODUCT	DATA SHEET			ACCEPTANCE ONLY FROM THE QUALIFIED PRODUCTS LIST MAILBOX PACKAGING/DATA SHEET MUST DISPLAY "MADE IN THE USA" MAILBOX CLUSTERS ARE NOT REQUIRED TO BE ON THE QUALIFIED PRODUCTS LIST

MATERIAL/ MATERIAL CODE	TESTS	SAMPLE SIZE	SAMPLE/TEST FREQUENCY	FIELD	DISTRICT/ AREA LAB	MDT HQ LAB	NOTES
STRUCTURAL TIMBER AND LUMBER 706.01.00.01	CERT/ VISUAL INSPECTION	N/A	ONE PER CHARGE	VISUAL			VERIFY SEAL NUMBERS CORRESPOND WITH PRE-INSPECTION RECORDS
	MT 404 INSPECTING WOOD PRODUCTS	20 BORINGS	ONE PER CHARGE			PRE-INSPECTION	

MISCELLANEOUS

MDT MATERIALS SAMPLING, TESTING, AND ACCEPTANCE GUIDE

MT 601 (12/31/19)

MISCELLANEOUS

SPECIALS, SUPPLEMENTAL AND STANDARD SPECS, DETAILED DWGS

MATERIAL/ MATERIAL CODE	TESTS	SAMPLE SIZE	SAMPLE/TEST FREQUENCY	FIELD	DISTRICT/ AREA LAB	MDT HQ LAB	NOTES
BITUMINOUS COATINGS 709.04.00.01	CERT/ VISUAL INSPECTION	1 EACH	ONE PER LOT OR BATCH	DATA SHEET			
STEEL STRUCTURE PAINT 710.01.00.01	CERT/ VISUAL INSPECTION	1 EACH	ONE PER LOT OR BATCH	DATA SHEET			SUBMIT CERT OF COMP WHEN REQUIRED PER SPECIFICATION 710.02 CATTLE GUARDS REQUIRE VISUAL INSPECTION ONLY
POWDER COATING 710.03.00.01	CERT/ VISUAL INSPECTION	1 EACH	ONE PER LOT OR BATCH	CERT OF COMP			
ANTI-GRAFFITI COATING 710.04.00.01	CERT/ VISUAL INSPECTION	1 EACH	ONE PER PRODUCT	DATA SHEET			ACCEPTANCE ONLY FROM THE QUALIFIED PRODUCTS LIST
MISCELLANEOUS MATERIAL ACCEPTED ON CERT 713.00.00.00	CERT/ VISUAL INSPECTION	1 EACH	ONE PER SOURCE	CERT OF COMP OR DATA SHEET			CERTIFICATION OF COMPLIANCE IF REQUIRED BY CONTRACT PROVISIONS
WATER FOR CONCRETE 713.01.00.01	CERT/ VISUAL INSPECTION	N/A	ONE PER SOURCE	VISUAL			
	AASHTO M 157 READY MIX CONCRETE	1 QT (1 LITER)	ONE PER SOURCE			TEST	SAMPLE REQUIRED ONLY IF NON-POTABLE SOURCE

MISCELLANEOUS

MDT MATERIALS SAMPLING, TESTING, AND ACCEPTANCE GUIDE

MISCELLANEOUS

SPECIALS, SUPPLEMENTAL AND STANDARD SPECS, DETAILED DWGS

MATERIAL/ MATERIAL CODE	TESTS	SAMPLE SIZE	SAMPLE/TEST FREQUENCY	FIELD	DISTRICT/ AREA LAB	MDT HQ LAB	NOTES
HYDRATED LIME 713.02.00.01	CERT/ VISUAL INSPECTION	1 EACH	ONE PER GRIND/BIN/SHIPMENT	DATA SHEET			QUALIFIED PRODUCTS LIST
	MT 201 SAMPLING	5 LBS (3 KG)	ONE PER PROJECT/ CONTRACT	SAMPLE			SAMPLE REQUIRED ONLY IF NOT ON THE QUALIFIED PRODUCTS LIST
	AASHTO M 303 LIME FOR ASPHALT MIXTURES					TEST	
AASHTO T 219 CHEMICAL ANALYSIS OF HYDRATED LIME	50 GRAM (2 OZ) AIRTIGHT				SAMPLE TEST		

MATERIAL/ MATERIAL CODE	TESTS	SAMPLE SIZE	SAMPLE/TEST FREQUENCY	FIELD	DISTRICT/ AREA LAB	MDT HQ LAB	NOTES
MAGNESIUM CHLORIDE 713.03.00.01	CERT/ VISUAL INSPECTION	1 EACH	ONE PER LOAD	DATA SHEET			QUALIFIED PRODUCTS LIST
	MT 408 SAMPLING LIQUID DEICING MATERIAL	1 PINT (500 mL)	ONE PER PROJECT				SAMPLE REQUIRED ONLY IF NOT ON THE QUALIFIED PRODUCTS LIST
	MT 502 CHEMICAL ANALYSIS					SAMPLE TEST	

MATERIAL/ MATERIAL CODE	TESTS	SAMPLE SIZE	SAMPLE/TEST FREQUENCY	FIELD	DISTRICT/ AREA LAB	MDT HQ LAB	NOTES
CALCIUM CHLORIDE 713.03.00.02	CERT/ VISUAL INSPECTION	1 EACH	ONE PER LOAD	DATA SHEET			QUALIFIED PRODUCTS LIST
	MT 408 SAMPLING LIQUID DEICING MATERIAL	1 PINT (500 mL)	ONE PER PROJECT				SAMPLE REQUIRED ONLY IF NOT ON THE QUALIFIED PRODUCTS LIST
	MT 502 CHEMICAL ANALYSIS					SAMPLE TEST	

MISCELLANEOUS

MDT MATERIALS SAMPLING, TESTING, AND ACCEPTANCE GUIDE

MT 601 (12/31/19)

MISCELLANEOUS

SPECIALS, SUPPLEMENTAL AND STANDARD SPECS, DETAILED DWGS

MATERIAL/ MATERIAL CODE	TESTS	SAMPLE SIZE	SAMPLE/TEST FREQUENCY	FIELD	DISTRICT/ AREA LAB	MDT HQ LAB	NOTES
STRUCTURAL CEMENT GROUT 713.04.00.01	CERT/ VISUAL INSPECTION	1 EACH	ONE PER LOT OR BATCH	DATA SHEET			CERTIFICATION IS THE MIXTURE AND GRADATION ON THE CONTAINER
	AASHTO R 64 CUBE SPECIMENS USING GROUT/MORTAR	1 CU FT (0.03 M3)	TWO SETS OF THREE CUBES PER EACH DAYS POUR	SAMPLE			
	AASHTO T 106 COMPRESSIVE STRENGTH OF MORTARS					TEST	

MATERIAL/ MATERIAL CODE	TESTS	SAMPLE SIZE	SAMPLE/TEST FREQUENCY	FIELD	DISTRICT/ AREA LAB	MDT HQ LAB	NOTES
CEMENT GROUT 713.04.00.02	CERT/ VISUAL INSPECTION	1 EACH	ONE PER LOT OR BATCH	DATA SHEET			CERTIFICATION IS THE MIXTURE AND GRADATION ON THE CONTAINER
	AASHTO R 64 CUBE SPECIMENS USING GROUT/MORTAR	1 CU FT (0.03 M3)	TWO SETS OF THREE CUBES PER EACH DAYS POUR	SAMPLE			
	AASHTO T 106 COMPRESSIVE STRENGTH OF MORTARS					TEST	

MATERIAL/ MATERIAL CODE	TESTS	SAMPLE SIZE	SAMPLE/TEST FREQUENCY	FIELD	DISTRICT/ AREA LAB	MDT HQ LAB	NOTES
MORTAR 713.04.00.03	CERT/ VISUAL INSPECTION	1 EACH	ONE PER LOT OR BATCH	DATA SHEET			

MISCELLANEOUS

MDT MATERIALS SAMPLING, TESTING, AND ACCEPTANCE GUIDE

MT 601 (12/31/19)

PAVEMENT MARKINGS

SPECIALS, SUPPLEMENTAL AND STANDARD SPECS, DETAILED DWGS

MATERIAL/ MATERIAL CODE	TESTS	SAMPLE SIZE	SAMPLE/TEST FREQUENCY	FIELD	DISTRICT/ AREA LAB	MDT HQ LAB	NOTES
TEMPORARY PAINT 714.03.00.01	CERT/ VISUAL INSPECTION	1 EACH	ONE PER LOT OR BATCH	DATA SHEET			ACCEPTANCE ONLY FROM THE QUALIFIED PRODUCTS LIST
WATERBORNE PAINT 714.04.00.01	CERT/ VISUAL INSPECTION	1 QT (1 LITER) IN PLASTIC BOTTLE	ONE PER LOT OR BATCH	DATA SHEET			ACCEPTANCE ONLY FROM THE QUALIFIED PRODUCTS LIST
HIGH DURABLE WATERBORNE PAINT 714.05.00.01	CERT/ VISUAL INSPECTION	1 QT (1 LITER) IN PLASTIC BOTTLE	ONE PER LOT OR BATCH	DATA SHEET			ACCEPTANCE ONLY FROM THE QUALIFIED PRODUCTS LIST
EPOXY PAINT 714.06.00.01	CERT/ VISUAL INSPECTION	1 EACH	ONE PER LOT OR BATCH	DATA SHEET			ACCEPTANCE ONLY FROM THE QUALIFIED PRODUCTS LIST
EPOXY PAINT 714.06.00.01	SPEC TABLE 714-4 EPOXY PAINT COMPOSITION	1 QT (1 LITER) OF EACH PIGMENT IN PLASTIC BOTTLES	AS REQUESTED	SAMPLE		TEST	ONE QUART (LITER) SAMPLE OF BOTH PIGMENT (COLOR) AND RESIN (CATALYST) WILL BE TAKEN FROM THE THOROUGHLY MIXED CONTENTS OF A STRIPING MACHINE
PREFORMED PLASTIC 714.07.00.01	CERT/ VISUAL INSPECTION	1 EACH	ONE PER TYPE	DATA SHEET			
PREFORMED PLASTIC 714.07.00.01	ASTM D638 TENSILE PROPERTIES	4" X 1' (100 mm x 300 mm)	ONE PER TYPE	SAMPLE		TEST	

PAVEMENT MARKINGS

PAVEMENT MARKINGS

SPECIALS, SUPPLEMENTAL AND STANDARD SPECS, DETAILED DWGS

MATERIAL/ MATERIAL CODE	TESTS	SAMPLE SIZE	SAMPLE/TEST FREQUENCY	FIELD	DISTRICT/ AREA LAB	MDT HQ LAB	NOTES
REFLECTIVE GLASS BEADS MT TYPE 1 714.08.00.01 MT TYPE 2 714.08.00.02	CERT/ VISUAL INSPECTION	1 EACH	ONE PER LOT OR BATCH	DATA SHEET			ACCEPTANCE ONLY FROM THE QUALIFIED PRODUCTS LIST
	AASHTO T 346 SAMPLING GLASS BEADS	1 QT (1 LITER)	<u>CONSTRUCTION</u> ONE PER PROJECT	SAMPLE		TEST	SAMPLE FROM BULK CONTAINER WITH THIEF/PROBE IN ACCORDANCE WITH AASHTO T 346. SAMPLE THIEF/PROBE MAY NOT FILL SAMPLE BOTTLES.
	AASHTO PP 74 GRADATION AND ROUNDNESS OF GLASS BEADS		<u>MAINTENANCE</u> AS REQUESTED				WHEN SAMPLING FROM A BULK CONTAINER IS NOT POSSIBLE, SAMPLES MAY BE COLLECTED FROM THE BEAD GUN ON THE TRUCK.

MDT MATERIALS SAMPLING, TESTING, AND ACCEPTANCE GUIDE

MT 601 (12/31/19)

PILE

SPECIALS, SUPPLEMENTAL AND STANDARD SPECS, DETAILED DWGS

MATERIAL/ MATERIAL CODE	TESTS	SAMPLE SIZE	SAMPLE/TEST FREQUENCY	FIELD	DISTRICT/ AREA LAB	MDT HQ LAB	NOTES
PILE DRIVING POINT 559.02.03.01	CERT/ VISUAL INSPECTION	1 EACH	ONE PER PRODUCT	CERT OF COMP			IF WELDING OCCURS, CERTIFICATE OF COMPLIANCE IS SUBMITTAL OF DOCUMENTATION PER SPECIFICATION 624.03.3
	STEEL CERT CATEGORY 2	1 EACH	ONE PER FORM 406	FORM 406			MANDATORY SUBMITTAL OF DOCUMENTATION PER SPECIFICATION 106.09

MATERIAL/ MATERIAL CODE	TESTS	SAMPLE SIZE	SAMPLE/TEST FREQUENCY	FIELD	DISTRICT/ AREA LAB	MDT HQ LAB	NOTES
PILE CUTTING SHOE 559.02.03.02	CERT/ VISUAL INSPECTION	1 EACH	ONE PER PRODUCT	CERT OF COMP			IF WELDING OCCURS, CERTIFICATE OF COMPLIANCE IS SUBMITTAL OF DOCUMENTATION PER SPECIFICATION 624.03.3
	STEEL CERT CATEGORY 2	1 EACH	ONE PER FORM 406	FORM 406			MANDATORY SUBMITTAL OF DOCUMENTATION PER SPECIFICATION 106.09

MATERIAL/ MATERIAL CODE	TESTS	SAMPLE SIZE	SAMPLE/TEST FREQUENCY	FIELD	DISTRICT/ AREA LAB	MDT HQ LAB	NOTES
STRUCTURAL STEEL PILES 711.10.01.01	CERT/ VISUAL INSPECTION	1 EACH	ONE PER EACH	CERT OF COMP VISUAL			IF WELDING OCCURS, CERTIFICATE OF COMPLIANCE IS SUBMITTAL OF DOCUMENTATION PER SPECIFICATION 624.03.3
	STEEL CERT CATEGORY 1	1 EACH	ONE PER FORM 406	FORM 406			MANDATORY SUBMITTAL OF DOCUMENTATION FOR EACH HEAT #. IF RECYCLED MATERIAL, BUY AMERICA CATEGORY 2 REQUIREMENTS APPLY
	STEEL CERT CATEGORY 2	1 EACH	ONE PER FORM 406	FORM 406			RECYCLED MATERIAL MANDATORY SUBMITTAL OF DOCUMENTATION PER SPECIFICATION 106.09

PILE

MDT MATERIALS SAMPLING, TESTING, AND ACCEPTANCE GUIDE

MT 601 (12/31/19)

PILE

SPECIALS, SUPPLEMENTAL AND STANDARD SPECS, DETAILED DWGS

MATERIAL/ MATERIAL CODE	TESTS	SAMPLE SIZE	SAMPLE/TEST FREQUENCY	FIELD	DISTRICT/ AREA LAB	MDT HQ LAB	NOTES
STEEL PIPE PILES 711.10.02.01	CERT/ VISUAL INSPECTION	1 EACH	ONE PER EACH	CERT OF COMP VISUAL			IF WELDING OCCURS, CERTIFICATE OF COMPLIANCE IS SUBMITTAL OF DOCUMENTATION PER SPECIFICATION 624.03.3
	STEEL CERT CATEGORY 1	1 EACH	ONE PER FORM 406	FORM 406			MANDATORY SUBMITTAL OF DOCUMENTATION FOR EACH HEAT #

PILE

MDT MATERIALS SAMPLING, TESTING, AND ACCEPTANCE GUIDE

MT 601 (12/31/19)

PIPES

SPECIALS, SUPPLEMENTAL AND STANDARD SPECS, DETAILED DWGS

MATERIAL/ MATERIAL CODE	TESTS	SAMPLE SIZE	SAMPLE/TEST FREQUENCY	FIELD	DISTRICT/ AREA LAB	MDT HQ LAB	NOTES
REINFORCED CONCRETE PIPE 708.01.00.01	CERT/ VISUAL INSPECTION	1 EACH	ONE PER PROJECT	VISUAL			ACCEPTANCE ONLY FROM THE QUALIFIED PRODUCTS LIST
	STEEL CERT CATEGORY 2	1 EACH	ONE PER FORM 406	FORM 406			MANDATORY SUBMITTAL OF DOCUMENTATION PER SPECIFICATION 106.09
	MT 110 RCP AND ASSOCIATED ITEMS	N/A	MONTHLY		PRE-INSPECTION		PLANTS NEED TO BE INSPECTED MONTHLY

MATERIAL/ MATERIAL CODE	TESTS	SAMPLE SIZE	SAMPLE/TEST FREQUENCY	FIELD	DISTRICT/ AREA LAB	MDT HQ LAB	NOTES
REINFORCED CONCRETE BOX 708.01.00.02	CERT/ VISUAL INSPECTION	1 EACH	ONE PER PROJECT	VISUAL			ACCEPTANCE ONLY FROM THE QUALIFIED PRODUCTS LIST
	STEEL CERT CATEGORY 2	1 EACH	ONE PER FORM 406	FORM 406			MANDATORY SUBMITTAL OF DOCUMENTATION PER SPECIFICATION 106.09
	MT 110 RCP AND ASSOCIATED ITEMS	N/A	MONTHLY		PRE-INSPECTION		PLANTS NEED TO BE INSPECTED MONTHLY

PIPES

MDT MATERIALS SAMPLING, TESTING, AND ACCEPTANCE GUIDE

MT 601 (12/31/19)

PIPES

SPECIALS, SUPPLEMENTAL AND STANDARD SPECS, DETAILED DWGS

MATERIAL/ MATERIAL CODE	TESTS	SAMPLE SIZE	SAMPLE/TEST FREQUENCY	FIELD	DISTRICT/ AREA LAB	MDT HQ LAB	NOTES
CONCRETE PRESSURE PIPE 708.02.00.01	CERT/ VISUAL INSPECTION	1 EACH	ONE PER PROJECT	VISUAL			PRE-INSPECTION IS NOT REQUIRED IF ITEM IS PRODUCED AT A CERTIFIED PLANT (QPL)
	STEEL CERT CATEGORY 2	1 EACH	ONE PER FORM 406	FORM 406			MANDATORY SUBMITTAL OF DOCUMENTATION PER SPECIFICATION 106.09
	MT 110 RCP AND ASSOCIATED ITEMS	N/A	MONTHLY			PRE-INSPECTION	PLANTS NEED TO BE INSPECTED MONTHLY, INCLUDING CERTIFIED PLANTS

MATERIAL/ MATERIAL CODE	TESTS	SAMPLE SIZE	SAMPLE/TEST FREQUENCY	FIELD	DISTRICT/ AREA LAB	MDT HQ LAB	NOTES
PLASTIC PIPE 708.05 708.06 708.07 708.08	CERT/ VISUAL INSPECTION	1 EACH	ONE PER LOT/BATCH	DATA SHEET			

MATERIAL/ MATERIAL CODE	TESTS	SAMPLE SIZE	SAMPLE/TEST FREQUENCY	FIELD	DISTRICT/ AREA LAB	MDT HQ LAB	NOTES
DUCTILE IRON WATER PIPE 709.01.01.01	CERT/ VISUAL INSPECTION	1 EACH	ONE PER ITEM	DATA SHEET VISUAL			
	STEEL CERT CATEGORY 2	1 EACH	ONE PER FORM 406	FORM 406			MANDATORY SUBMITTAL OF DOCUMENTATION PER SPECIFICATION 106.09

PIPES

MDT MATERIALS SAMPLING, TESTING, AND ACCEPTANCE GUIDE

MT 601 (12/31/19)

PIPES

SPECIALS, SUPPLEMENTAL AND STANDARD SPECS, DETAILED DWGS

MATERIAL/ MATERIAL CODE	TESTS	SAMPLE SIZE	SAMPLE/TEST FREQUENCY	FIELD	DISTRICT/ AREA LAB	MDT HQ LAB	NOTES
STEEL WATER PIPE 709.01.02.01	CERT/ VISUAL INSPECTION	1 EACH	ONE PER ITEM	DATA SHEET OR CERT OF COMP VISUAL			IF WELDING OCCURS, CERTIFICATE OF COMPLIANCE IS SUBMITTAL OF DOCUMENTATION PER SPECIFICATION 624.03.3
	STEEL CERT CATEGORY 2	1 EACH	ONE PER FORM 406	FORM 406			MANDATORY SUBMITTAL OF DOCUMENTATION PER SPECIFICATION 106.09

MATERIAL/ MATERIAL CODE	TESTS	SAMPLE SIZE	SAMPLE/TEST FREQUENCY	FIELD	DISTRICT/ AREA LAB	MDT HQ LAB	NOTES
CORRUGATED STEEL PIPE 709.02.00.01	CERT/ VISUAL INSPECTION	1 EACH	ONE PER ITEM	DATA SHEET VISUAL			
	STEEL CERT CATEGORY 2	1 EACH	ONE PER FORM 406	FORM 406			MANDATORY SUBMITTAL OF DOCUMENTATION PER SPECIFICATION 106.09

MATERIAL/ MATERIAL CODE	TESTS	SAMPLE SIZE	SAMPLE/TEST FREQUENCY	FIELD	DISTRICT/ AREA LAB	MDT HQ LAB	NOTES
STEEL STRUCTURAL PLATE PIPE 709.03.00.01	CERT/ VISUAL INSPECTION	1 EACH	ONE PER ITEM	DATA SHEET VISUAL			
	STEEL CERT CATEGORY 2	1 EACH	ONE PER FORM 406	FORM 406			MANDATORY SUBMITTAL OF DOCUMENTATION PER SPECIFICATION 106.09

MATERIAL/ MATERIAL CODE	TESTS	SAMPLE SIZE	SAMPLE/TEST FREQUENCY	FIELD	DISTRICT/ AREA LAB	MDT HQ LAB	NOTES
CORR ALUMINUM PIPE CULVERT 709.07.00.01	CERT/ VISUAL INSPECTION	1 EACH	ONE PER ITEM	DATA SHEET VISUAL			

PIPES

MDT MATERIALS SAMPLING, TESTING, AND ACCEPTANCE GUIDE

MT 601 (12/31/19)

PIPES

SPECIALS, SUPPLEMENTAL AND STANDARD SPECS, DETAILED DWGS

MATERIAL/ MATERIAL CODE	TESTS	SAMPLE SIZE	SAMPLE/TEST FREQUENCY	FIELD	DISTRICT/ AREA LAB	MDT HQ LAB	NOTES
SEAMLESS STEEL PIPE 709.09.00.01	CERT/ VISUAL INSPECTION	1 EACH	ONE PER ITEM	DATA SHEET OR CERT OF COMP VISUAL			IF WELDING OCCURS, CERTIFICATE OF COMPLIANCE IS SUBMITTAL OF DOCUMENTATION PER SPECIFICATION 624.03.3
	STEEL CERT CATEGORY 2	1 EACH	ONE PER FORM 406	FORM 406			MANDATORY SUBMITTAL OF DOCUMENTATION PER SPECIFICATION 106.09
MATERIAL/ MATERIAL CODE	TESTS	SAMPLE SIZE	SAMPLE/TEST FREQUENCY	FIELD	DISTRICT/ AREA LAB	MDT HQ LAB	NOTES
COPPER PIPE 709.10.00.01	CERT/ VISUAL INSPECTION	1 EACH	ONE PER ITEM	DATA SHEET VISUAL			
MATERIAL/ MATERIAL CODE	TESTS	SAMPLE SIZE	SAMPLE/TEST FREQUENCY	FIELD	DISTRICT/ AREA LAB	MDT HQ LAB	NOTES
SOILS/WATER FOR PIPE CORROSION PC 3	MT 207 WATER CORROSION	1 QT (1 LITER)	PROBABLE, PROPOSED OR EXISTING CENTERLINE OF PIPE, CHANNEL BOTTOM, BRIDGE LOCATIONS AND PROBABLE BORROW AREAS		SAMPLE	TEST	
	MT 232 SOILS CORROSION	5 LB (3 KG)			SAMPLE	TEST	

PIPES

PLANT MIX PAVEMENT

MDT MATERIALS SAMPLING, TESTING, AND ACCEPTANCE GUIDE
 SPECIALS, SUPPLEMENTAL AND STANDARD SPECS, DETAILED DWGS

MT 601 (12/31/19)

MATERIAL/ MATERIAL CODE	TESTS	SAMPLE SIZE	SAMPLE/TEST FREQUENCY	FIELD	DISTRICT/ AREA LAB	MDT HQ LAB	NOTES
WARM MIX ADDITIVE 401.02.04.01	CERT/ VISUAL INSPECTION	1 EACH	ONE PER EACH	DATA SHEET			ACCEPTANCE ONLY FROM THE QUALIFIED PRODUCTS LIST

MATERIAL/ MATERIAL CODE	TESTS	SAMPLE SIZE	SAMPLE/TEST FREQUENCY	FIELD	DISTRICT/ AREA LAB	MDT HQ LAB	NOTES
ANTI-STRIPPING ADDITIVE 401.02.05.01	CERT/ VISUAL INSPECTION	1 EACH	ONE PER EACH	DATA SHEET			

MATERIAL/ MATERIAL CODE	TESTS	SAMPLE SIZE	SAMPLE/TEST FREQUENCY	FIELD	DISTRICT/ AREA LAB	MDT HQ LAB	NOTES
RECYCLING AGENT 401.02.05.02	CERT/ VISUAL INSPECTION	1 EACH	ONE PER EACH	DATA SHEET			

PLANT MIX PAVEMENT

MDT MATERIALS SAMPLING, TESTING, AND ACCEPTANCE GUIDE
 SPECIALS, SUPPLEMENTAL AND STANDARD SPECS, DETAILED DWGS

MT 601 (12/31/19)

MATERIAL/ MATERIAL CODE	TESTS	SAMPLE SIZE	SAMPLE/TEST FREQUENCY	FIELD	DISTRICT/ AREA LAB	MDT HQ LAB	NOTES		
PLANT MIX SURFACING GRADE S (3/4") 401.03.00.01 GRADE S (1/2") 401.03.00.02 GRADE S (3/8") 401.03.00.03	MT 303 SAMPLING BITUMINOUS PAVING MIXTURES	SUFFICIENT QUANTITY IN 2-10 QUART (9.5 LITER) GALVANIZED BUCKETS	ONE EVERY 1000 TONS (MT) OF PLANT MIX PAVEMENT <u>COMMERCIAL MIXES</u> ONE EVERY 2000 TONS (MT) OF PLANT MIX PAVEMENT WITH A MINIMUM OF ONE SAMPLE FOR PROJECTS OVER 500 TONS (MT) (NO TESTS ARE REQUIRED FOR CONTRACTS UNDER 500 TONS (MT))		SAMPLE TEST				
	AASHTO R 47 REDUCING SAMPLES		MINIMUM ONE PER DAY						
	AASHTO T 329 MOISTURE CONTENT		ONE EVERY 1000 TONS (MTONS) OF PLANT MIX PAVEMENT <u>COMMERCIAL MIXES</u> ONE EVERY 2000 TONS (MT) OF PLANT MIX PAVEMENT WITH A MINIMUM OF ONE SAMPLE FOR PROJECTS OVER 500 TONS (MT) (NO TESTS ARE REQUIRED FOR CONTRACTS UNDER 500 TONS (MT))	TEST					
	AASHTO T 166 BULK SPECIFIC GRAVITY								
	MT 319 BINDER CONTENT BY IGNITION METHOD								
	MT 320 IGNITION OVEN AGGREGATE ANALYSIS								
	MT 321 RICE SPECIFIC GRAVITY								
	MT 332 GYRATORY COMPACTION								
	MT 334 HAMBURG WHEEL- TRACK		45 LBS (20 KG)	ONCE INITIAL JOB MIX TARGETS ARE ESTABLISHED OR FOR START-UP MIX WITH TEST RESULTS OUTSIDE THE BROADBAND LIMITS			SAMPLE	TEST	ADDITIONAL SAMPLES MAY BE TAKEN AT EPM'S DISCRETION
	MT 335 LINEAR KNEADING COMPACTION								
DENSITY BY CORE	2 - 4" CORES	ONE EVERY 600 TONS (MT) PMP	SAMPLE	TEST		SPECIAL PROVISION SECTION 401.03.21			
MT 602 FINAL RECORD	2 CORES	PER TWO LANE MILE TAKEN AT 1/2 MILE (1 KM) INTERVALS		SAMPLE TEST					

PLANT MIX PAVEMENT

PLANT MIX PAVEMENT

MDT MATERIALS SAMPLING, TESTING, AND ACCEPTANCE GUIDE
 SPECIALS, SUPPLEMENTAL AND STANDARD SPECS, DETAILED DWGS

MT 601 (12/31/19)

MATERIAL/ MATERIAL CODE	INDEPENDENT ASSURANCE (PROCEDURAL CHECK)			FIELD	DISTRICT/ AREA LAB	MDT HQ LAB	NOTES
PLANT MIX SURFACING GRADE S (3/4") 401.03.00.01 GRADE S (1/2") 401.03.00.02 GRADE S (3/8") 401.03.00.03	AASHTO R 47 REDUCING SAMPLES	N/A	ONCE PER PROJECT		CHECK	CHECK	PROCEDURAL CHECK MAY BE PERFORMED BY THE DISTRICT/AREA LAB OR MDT HQ LAB
	AASHTO T 166 BULK SPECIFIC GRAVITY						
	MT 319 BINDER CONTENT BY IGNITION METHOD						
	MT 320 IGNITION OVEN AGGREGATE ANALYSIS						
	MT 321 RICE SPECIFIC GRAVITY						
	MT 332 GYRATORY COMPACTION						

PLANT MIX PAVEMENT

MDT MATERIALS SAMPLING, TESTING, AND ACCEPTANCE GUIDE
 SPECIALS, SUPPLEMENTAL AND STANDARD SPECS, DETAILED DWGS

MT 601 (12/31/19)

MATERIAL/ MATERIAL CODE	Mix Design		FIELD	DISTRICT/ AREA LAB	MDT HQ LAB	NOTES	
PLANT MIX SURFACING GRADE S (3/4") 401.03.00.01 GRADE S (1/2") 401.03.00.02 GRADE S (3/8") 401.03.00.03	MT 201 SAMPLING	800 LBS (636 KG)	ONE PER PLANT MIX DESIGN VERIFICATION		SAMPLE		
	MT 202 SIEVE ANALYSIS						
	AASHTO T 96 L.A. ABRASION						
	AASHTO T 176 SAND EQUIVALENT					PRIMARY	
	MT 305 VOLUME SWELL CALIPER/MERCURY					SECONDARY	
	AASHTO T 335 FRACTURE						
	AASHTO T 304 FINE AGGREGATE ANGULARITY						
	ASTM D4791 FLAT & ELONGATED PARTICLES						
	AASHTO T 84 SPECIFIC GRAVITY FINE AGG						
	AASHTO T 85 SPECIFIC GRAVITY COARSE AGG					TEST	
	AASHTO R 47 REDUCING SAMPLES						
	AASHTO T 166 BULK SPECIFIC GRAVITY						
	MT 321 RICE SPECIFIC GRAVITY						
	MT 332 GYRATORY COMPACTION						
	MT 334 HAMBURG WHEEL-TRACK						
	MT 335 LINEAR KNEADING COMPACTION						
	MT 319 BINDER CONTENT BY IGNITION METHOD						USED FOR PLANT MIX DESIGNS CONTAINING RAP
	MT 320 IGNITION OVEN AGGREGATE ANALYSIS						

MATERIAL/ MATERIAL CODE	TESTS	SAMPLE SIZE	SAMPLE/TEST FREQUENCY	FIELD	DISTRICT/ AREA LAB	MDT HQ LAB	NOTES
PLANT MIX SEAL COURSE 401.03.00.04	AASHTO T 335 FRACTURE	20 LBS (9 KG)	ONE EVERY 600 TONS (MT) PMSC		SAMPLE TEST		
	MT 303 SAMPLING BITUMINOUS PAVING MIXTURES						
	AASHTO R 47 REDUCING SAMPLES						
	MT 319 BINDER CONTENT BY IGNITION METHOD						
	MT 320 IGNITION OVEN AGGREGATE ANALYSIS			TEST			
INDEPENDENT ASSURANCE (PROCEDURAL CHECK)				FIELD	DISTRICT/ AREA LAB	MDT HQ LAB	NOTES
	AASHTO R 47 REDUCING SAMPLES	N/A	ONCE PER PROJECT		CHECK	CHECK	PROCEDURAL CHECK MAY BE PERFORMED BY THE DISTRICT/AREA LAB OR MDT HQ LAB
	MT 319 BINDER CONTENT BY IGNITION METHOD						
	MT 320 IGNITION OVEN AGGREGATE ANALYSIS						

PLANT MIX PAVEMENT

MDT MATERIALS SAMPLING, TESTING, AND ACCEPTANCE GUIDE
 SPECIALS, SUPPLEMENTAL AND STANDARD SPECS, DETAILED DWGS

MT 601 (12/31/19)

MATERIAL/ MATERIAL CODE	Mix Design		FIELD	DISTRICT/ AREA LAB	MDT HQ LAB	NOTES	
PLANT MIX SEAL COURSE 401.03.00.04	MT 201 SAMPLING	800 LBS (363 KG)	ONE PER PLANT MIX SEAL COURSE MIX DESIGN		SAMPLE		
	MT 202 SIEVE ANALYSIS						
	AASHTO T 84 SPECIFIC GRAVITY FINE AGG						
	AASHTO T 85 SPECIFIC GRAVITY COARSE AGG						
	AASHTO T 89 LIQUID LIMIT						
	AASHTO T 90 PLASTIC LIMIT & PLASTICITY INDEX						
	AASHTO T 96 LOS ANGELES ABRASION						
	AASHTO T 176 SAND EQUIVALENT TEST					TEST	
	AASHTO T 335 FRACTURE						
	MT 305 VOLUME SWELL CALIPER/MERCURY						
	AASHTO T 304 FINE AGGREGATE ANGULARITY						
	ASTM D4791 FLAT & ELONGATED PARTICLES						
	ASTM D6390 DRAIN DOWN						
	MT 332 GYRATORY COMPACTION						VERIFY

PLANT MIX PAVEMENT

MDT MATERIALS SAMPLING, TESTING, AND ACCEPTANCE GUIDE
 SPECIALS, SUPPLEMENTAL AND STANDARD SPECS, DETAILED DWGS

MT 601 (12/31/19)

MATERIAL/ MATERIAL CODE	TESTS	SAMPLE SIZE	SAMPLE/TEST FREQUENCY	FIELD	DISTRICT/ AREA LAB	MDT HQ LAB	NOTES
COLD RECYCLING ASPHALT EMULSION 405.02.00.01	CERT/ VISUAL INSPECTION	1 EACH	ONE PER LOT OR BATCH	CERT OF COMP			

MATERIAL/ MATERIAL CODE	TESTS	SAMPLE SIZE	SAMPLE/TEST FREQUENCY	FIELD	DISTRICT/ AREA LAB	MDT HQ LAB	NOTES
COLD RECYCLED PLANT MIX 405.03.00.01	CERT/ VISUAL INSPECTION	N/A	ONE PER PROJECT	VISUAL			VERIFY ITEM MEETS MDT REQUIREMENTS
	AASHTO T 329 MOISTURE CONTENT	MINIMUM 2.2 LB (1 KG) MOISTURE PROOF CONTAINER	ONE EVERY 3000 FT PAVER PATH	SAMPLE	TEST		
	Mix Design			FIELD	DISTRICT/ AREA LAB	MDT HQ LAB	NOTES
	CERT/ VISUAL INSPECTION	1 EACH	ONE PER COLD RECYCLED PLANT MIX DESIGN	MIX DESIGN		APPROVAL	CERTIFICATION IS THE CONTRACTOR'S MIX DESIGN

MATERIAL/ MATERIAL CODE	TESTS	SAMPLE SIZE	SAMPLE/TEST FREQUENCY	FIELD	DISTRICT/ AREA LAB	MDT HQ LAB	NOTES
CORES FOR STRIPPING ANALYSIS PC 4	MT 331 SAMPLING & EVALUATING STRIPPING PAVEMENTS	1 EACH	SEE MT 331		SAMPLE	TEST	

MATERIAL/ MATERIAL CODE	TESTS	SAMPLE SIZE	SAMPLE/TEST FREQUENCY	FIELD	DISTRICT/ AREA LAB	MDT HQ LAB	NOTES
PRECONSTRUCTION SOIL CHEMISTRY PC5	MT 232 SOILS CORROSION	5 LB (3 KG)	ONE PER LOCATION		SAMPLE	TEST	

MATERIAL/ MATERIAL CODE	TESTS	SAMPLE SIZE	SAMPLE/TEST FREQUENCY	FIELD	DISTRICT/ AREA LAB	MDT HQ LAB	NOTES
HOT IN PLACE RECYCLE CORES PC6	MT 331 SAMPLING & EVALUATING STRIPPING PAVEMENTS	1 EACH	SEE MT 331		SAMPLE	TEST	

PLANT MIX PAVEMENT

MDT MATERIALS SAMPLING, TESTING, AND ACCEPTANCE GUIDE

MT 601 (12/31/19)

REVEGETATION

SPECIALS, SUPPLEMENTAL AND STANDARD SPECS, DETAILED DWGS

MATERIAL/ MATERIAL CODE	TESTS	SAMPLE SIZE	SAMPLE/TEST FREQUENCY	FIELD	DISTRICT/ AREA LAB	MDT HQ LAB	NOTES
PLANTS - TREES & SHRUBS 610.01.00.01	CERT/ VISUAL INSPECTION	1 EACH	ONE PER ITEM	DATA SHEET VISUAL			VERIFY ITEM MEETS MDT REQUIREMENTS

MATERIAL/ MATERIAL CODE	TESTS	SAMPLE SIZE	SAMPLE/TEST FREQUENCY	FIELD	DISTRICT/ AREA LAB	MDT HQ LAB	NOTES
TOPSOIL 713.05.00.01	MT 412 TOP SOIL	2 LBS (1 KG)	ONE TEST PER SOURCE	SAMPLE TEST			TESTING REQUIRED ON IMPORTED TOPSOIL ONLY

MATERIAL/ MATERIAL CODE	TESTS	SAMPLE SIZE	SAMPLE/TEST FREQUENCY	FIELD	DISTRICT/ AREA LAB	MDT HQ LAB	NOTES
LANDSCAPE GRADE TOPSOIL 713.05.00.02	MT 412 TOP SOIL	2 LBS (1 KG)	ONE TEST PER SOURCE	SAMPLE TEST			TESTING REQUIRED ON IMPORTED TOPSOIL ONLY

MATERIAL/ MATERIAL CODE	TESTS	SAMPLE SIZE	SAMPLE/TEST FREQUENCY	FIELD	DISTRICT/ AREA LAB	MDT HQ LAB	NOTES
WEED CONTROL MAT 713.06.00.01	CERT/ VISUAL INSPECTION	1 EACH	ONE PER LOT OR BATCH	DATA SHEET			

MATERIAL/ MATERIAL CODE	TESTS	SAMPLE SIZE	SAMPLE/TEST FREQUENCY	FIELD	DISTRICT/ AREA LAB	MDT HQ LAB	NOTES
RECLAMATION SEED 713.08.00.01	CERT/ VISUAL INSPECTION	1 EACH	ONE PER BLEND	DATA SHEET			ACCEPTANCE ONLY FROM THE QUALIFIED PRODUCTS LIST

MATERIAL/ MATERIAL CODE	TESTS	SAMPLE SIZE	SAMPLE/TEST FREQUENCY	FIELD	DISTRICT/ AREA LAB	MDT HQ LAB	NOTES
LANDSCAPING SEED 713.08.00.02	CERT/ VISUAL INSPECTION	1 EACH	ONE PER BLEND	DATA SHEET			

MATERIAL/ MATERIAL CODE	TESTS	SAMPLE SIZE	SAMPLE/TEST FREQUENCY	FIELD	DISTRICT/ AREA LAB	MDT HQ LAB	NOTES
FERTILIZER 713.09.00.01	CERT/ VISUAL INSPECTION	1 EACH	ONE PER BLEND	DATA SHEET			MUST MEET MT FERTILIZING LAWS

REVEGETATION

MDT MATERIALS SAMPLING, TESTING, AND ACCEPTANCE GUIDE

MT 601 (12/31/19)

REVEGETATION

SPECIALS, SUPPLEMENTAL AND STANDARD SPECS, DETAILED DWGS

MATERIAL/ MATERIAL CODE	TESTS	SAMPLE SIZE	SAMPLE/TEST FREQUENCY	FIELD	DISTRICT/ AREA LAB	MDT HQ LAB	NOTES
MULCH 713.10.00.01	CERT/ VISUAL INSPECTION	1 EACH	ONE PER BLEND	CERT OF COMP OR DATA SHEET			ACCEPTANCE ONLY FROM THE QUALIFIED PRODUCTS LIST CERTIFICATE OF COMPLIANCE IS REQUIRED FOR ALL MULCH THAT CONTAINS STRAW

MATERIAL/ MATERIAL CODE	TESTS	SAMPLE SIZE	SAMPLE/TEST FREQUENCY	FIELD	DISTRICT/ AREA LAB	MDT HQ LAB	NOTES
SOD 713.11.00.01	CERT/ VISUAL INSPECTION	1 EACH	ONE PER SUPPLIER	DATA SHEET			

MATERIAL/ MATERIAL CODE	TESTS	SAMPLE SIZE	SAMPLE/TEST FREQUENCY	FIELD	DISTRICT/ AREA LAB	MDT HQ LAB	NOTES
COMPOST 713.13.00.01	CERT/ VISUAL INSPECTION	1 EACH	ONE PER SUPPLIER	CERT OF COMP OR DATA SHEET			ACCEPTANCE ONLY FROM THE QUALIFIED PRODUCTS LIST CERTIFICATE OF COMPLIANCE IS REQUIRED FOR ALL COMPOST THAT CONTAINS STRAW

REVEGETATION

MDT MATERIALS SAMPLING, TESTING, AND ACCEPTANCE GUIDE

MT 601 (12/31/19)

SIGNING

SPECIALS, SUPPLEMENTAL AND STANDARD SPECS, DETAILED DWGS

MATERIAL/ MATERIAL CODE	TESTS	SAMPLE SIZE	SAMPLE/TEST FREQUENCY	FIELD	DISTRICT/ AREA LAB	MDT HQ LAB	NOTES
ALUMINUM SIGN SHEETING 704.01.01.01	CERT/ VISUAL INSPECTION	1 EACH	ONE PER LOT/BATCH	DATA SHEET VISUAL			
MATERIAL/ MATERIAL CODE	TESTS	SAMPLE SIZE	SAMPLE/TEST FREQUENCY	FIELD	DISTRICT/ AREA LAB	MDT HQ LAB	NOTES
STEEL SIGN POSTS	CERT/ VISUAL INSPECTION	1 EACH	ONE PER EACH	DATA SHEET			
704.01.04.01	STEEL CERT CATEGORY 2	1 EACH	ONE PER FORM 406	FORM 406			MANDATORY SUBMITTAL OF DOCUMENTATION PER SPECIFICATION 106.09
MATERIAL/ MATERIAL CODE	TESTS	SAMPLE SIZE	SAMPLE/TEST FREQUENCY	FIELD	DISTRICT/ AREA LAB	MDT HQ LAB	NOTES
STRUCTURAL STEEL SIGN POSTS	CERT/ VISUAL INSPECTION	1 EACH	ONE PER EACH	DATA SHEET VISUAL			
704.01.04.02	STEEL CERT CATEGORY 2	1 EACH	ONE PER FORM 406	FORM 406			MANDATORY SUBMITTAL OF DOCUMENTATION PER SPECIFICATION 106.09
MATERIAL/ MATERIAL CODE	TESTS	SAMPLE SIZE	SAMPLE/TEST FREQUENCY	FIELD	DISTRICT/ AREA LAB	MDT HQ LAB	NOTES
BREAKAWAY DEVICES	CERT/ VISUAL INSPECTION	1 EACH	ONE PER EACH	DATA SHEET			ACCEPTANCE ONLY FROM THE QUALIFIED PRODUCTS LIST
704.01.04.03	STEEL CERT CATEGORY 2	1 EACH	ONE PER FORM 406	FORM 406			MANDATORY SUBMITTAL OF DOCUMENTATION PER SPECIFICATION 106.09
MATERIAL/ MATERIAL CODE	TESTS	SAMPLE SIZE	SAMPLE/TEST FREQUENCY	FIELD	DISTRICT/ AREA LAB	MDT HQ LAB	NOTES
TREATED WOOD POSTS & POLES	CERT/ VISUAL INSPECTION	N/A	ONE PER LOT/BATCH	VISUAL			VERIFY SEAL NUMBERS CORRESPOND WITH PRE-INSPECTION RECORDS
704.01.06.01	MT 404 INSPECTING WOOD PRODUCTS	20 BORINGS	ONE PER CHARGE			PRE-INSPECTION	

SIGNING

MDT MATERIALS SAMPLING, TESTING, AND ACCEPTANCE GUIDE

MT 601 (12/31/19)

SIGNING

SPECIALS, SUPPLEMENTAL AND STANDARD SPECS, DETAILED DWGS

MATERIAL/ MATERIAL CODE	TESTS	SAMPLE SIZE	SAMPLE/TEST FREQUENCY	FIELD	DISTRICT/ AREA LAB	MDT HQ LAB	NOTES
RETRO-REFLECTIVE SHEETING 704.01.10.01	CERT/ VISUAL INSPECTION	1 EACH	ONE PER LOT/BATCH	DATA SHEET			
SURFACE MOUNT FLEXIBLE DELINEATORS 704.03.00.01	CERT/ VISUAL INSPECTION	1 EACH	ONE PER LOT/BATCH	DATA SHEET VISUAL			ACCEPTANCE ONLY FROM THE QUALIFIED PRODUCTS LIST
DRIVABLE FLEXIBLE DELINEATORS 704.03.00.02	CERT/ VISUAL INSPECTION	1 EACH	ONE PER LOT/BATCH	DATA SHEET VISUAL			ACCEPTANCE ONLY FROM THE QUALIFIED PRODUCTS LIST
	STEEL CERT CATEGORY 2	1 EACH	ONE PER FORM 406	FORM 406			MANDATORY SUBMITTAL OF DOCUMENTATION PER SPECIFICATION 106.09
OVERHEAD STRUCTURES 704.08.01.01	CERT/ VISUAL INSPECTION	N/A	ONE PER EACH	VISUAL	PRE-INSPECTION		
	STEEL CERT CATEGORY 1	1 EACH	ONE PER FORM 406	FORM 406			MANDATORY SUBMITTAL OF DOCUMENTATION FOR EACH HEAT #

SIGNING

MDT MATERIALS SAMPLING, TESTING, AND ACCEPTANCE GUIDE

MT 601 (12/31/19)

STEEL

SPECIALS, SUPPLEMENTAL AND STANDARD SPECS, DETAILED DWGS

MATERIAL/ MATERIAL CODE	TESTS	SAMPLE SIZE	SAMPLE/TEST FREQUENCY	FIELD	DISTRICT/ AREA LAB	MDT HQ LAB	NOTES
STEEL RAILING	CERT/ VISUAL INSPECTION	1 EACH	ONE PER SHIPMENT	DATA SHEET			
711.00.00.01	STEEL CERT CATEGORY 2	1 EACH	ONE PER FORM 406	FORM 406			MANDATORY SUBMITTAL OF DOCUMENTATION PER SPECIFICATION 106.09

MATERIAL/ MATERIAL CODE	TESTS	SAMPLE SIZE	SAMPLE/TEST FREQUENCY	FIELD	DISTRICT/ AREA LAB	MDT HQ LAB	NOTES
ROCK/SOIL ANCHOR	CERT/ VISUAL INSPECTION	1 EACH	ONE PER LOT/ITEM	DATA SHEET			
711.01.00.01	STEEL CERT CATEGORY 2	1 EACH	ONE PER FORM 406	FORM 406			MANDATORY SUBMITTAL OF DOCUMENTATION PER SPECIFICATION 106.09 DOES NOT APPLY TO BIT

MATERIAL/ MATERIAL CODE	TESTS	SAMPLE SIZE	SAMPLE/TEST FREQUENCY	FIELD	DISTRICT/ AREA LAB	MDT HQ LAB	NOTES
REBAR GRADE 40 711.01.01.01	CERT/ VISUAL INSPECTION	1 EACH	ONE PER SHIPMENT	DATA SHEET			ACCEPTANCE ONLY FROM THE QUALIFIED PRODUCTS LIST
GRADE 60 711.01.01.02	STEEL CERT CATEGORY 2	1 EACH	ONE PER FORM 406	FORM 406			MANDATORY SUBMITTAL OF DOCUMENTATION PER SPECIFICATION 106.09
GRADE 75 711.01.01.03							

MATERIAL/ MATERIAL CODE	TESTS	SAMPLE SIZE	SAMPLE/TEST FREQUENCY	FIELD	DISTRICT/ AREA LAB	MDT HQ LAB	NOTES
SMOOTH DOWEL BAR GRADE 40	CERT/ VISUAL INSPECTION	1 EACH	ONE PER SHIPMENT	DATA SHEET			ACCEPTANCE ONLY FROM THE QUALIFIED PRODUCTS LIST
711.01.01.04	STEEL CERT CATEGORY 2	1 EACH	ONE PER FORM 406	FORM 406			MANDATORY SUBMITTAL OF DOCUMENTATION PER SPECIFICATION 106.09

MATERIAL/ MATERIAL CODE	TESTS	SAMPLE SIZE	SAMPLE/TEST FREQUENCY	FIELD	DISTRICT/ AREA LAB	MDT HQ LAB	NOTES
REBAR EPOXY COATING 711.01.02.01	CERT/ VISUAL INSPECTION	1 EACH	ONE PER SHIPMENT	DATA SHEET VISUAL			ACCEPTANCE ONLY FROM THE QUALIFIED PRODUCTS LIST

STEEL

MDT MATERIALS SAMPLING, TESTING, AND ACCEPTANCE GUIDE

MT 601 (12/31/19)

STEEL

SPECIALS, SUPPLEMENTAL AND STANDARD SPECS, DETAILED DWGS

MATERIAL/ MATERIAL CODE	TESTS	SAMPLE SIZE	SAMPLE/TEST FREQUENCY	FIELD	DISTRICT/ AREA LAB	MDT HQ LAB	NOTES
REINFORCING WIRE, WIRE MESH 711.01.03.01	CERT/ VISUAL INSPECTION	1 EACH	ONE PER SHIPMENT	DATA SHEET			ACCEPTANCE ONLY FROM THE QUALIFIED PRODUCTS LIST
	STEEL CERT CATEGORY 2	1 EACH	ONE PER FORM 406	FORM 406			MANDATORY SUBMITTAL OF DOCUMENTATION PER SPECIFICATION 106.09

MATERIAL/ MATERIAL CODE	TESTS	SAMPLE SIZE	SAMPLE/TEST FREQUENCY	FIELD	DISTRICT/ AREA LAB	MDT HQ LAB	NOTES
REBAR-CORROSION RESISTANT-CR- GR100 711.01.04.01	CERT/ VISUAL INSPECTION	N/A	ONE PER SHIPMENT	DATA SHEET			
	STEEL CERT CATEGORY 2	1 EACH	ONE PER FORM 406	FORM 406			MANDATORY SUBMITTAL OF DOCUMENTATION PER SPECIFICATION 106.09
	MT 414 REINFORCING STEEL	2 - 3 FT (2 - 1 M)	ONE TEST PER BAR SIZE	SAMPLE		TEST	

MATERIAL/ MATERIAL CODE	TESTS	SAMPLE SIZE	SAMPLE/TEST FREQUENCY	FIELD	DISTRICT/ AREA LAB	MDT HQ LAB	NOTES
REBAR-CORROSION RESISTANT-SS-GR60 711.01.04.02	CERT/ VISUAL INSPECTION	N/A	ONE PER SHIPMENT	DATA SHEET			
	STEEL CERT CATEGORY 2	1 EACH	ONE PER FORM 406	FORM 406			MANDATORY SUBMITTAL OF DOCUMENTATION PER SPECIFICATION 106.09
	MT 414 REINFORCING STEEL	2 - 3 FT (2 - 1 M)	ONE TEST PER BAR SIZE	SAMPLE		TEST	

MATERIAL/ MATERIAL CODE	TESTS	SAMPLE SIZE	SAMPLE/TEST FREQUENCY	FIELD	DISTRICT/ AREA LAB	MDT HQ LAB	NOTES
STRUCTURAL STEEL 711.02.00.01	CERT/ VISUAL INSPECTION	1 EACH	ONE PER SHIPMENT	DATA SHEET OR CERT OF COMP			IF WELDING OCCURS, CERTIFICATE OF COMPLIANCE IS SUBMITTAL OF DOCUMENTATION PER SPECIFICATION 624.03.3
	STEEL CERT CATEGORY 1	1 EACH	ONE PER FORM 406	FORM 406			MANDATORY SUBMITTAL OF DOCUMENTATION FOR EACH HEAT # REQUIRED ONLY IF MATERIAL HAS NOT BEEN PRE-INSPECTED
	MT 415 STRUCTURAL STEEL	1 EACH	ONE PER ITEM			PRE-INSPECTION	

STEEL

MDT MATERIALS SAMPLING, TESTING, AND ACCEPTANCE GUIDE

MT 601 (12/31/19)

STEEL

SPECIALS, SUPPLEMENTAL AND STANDARD SPECS, DETAILED DWGS

MATERIAL/ MATERIAL CODE	TESTS	SAMPLE SIZE	SAMPLE/TEST FREQUENCY	FIELD	DISTRICT/ AREA LAB	MDT HQ LAB	NOTES
STRUCTURAL STEEL TUBING 711.03.00.01	CERT/ VISUAL INSPECTION	1 EACH	ONE PER ITEM	DATA SHEET OR CERT OF COMP			IF WELDING OCCURS, CERTIFICATE OF COMPLIANCE IS SUBMITTAL OF DOCUMENTATION PER SPECIFICATION 624.03.3
	STEEL CERT CATEGORY 1	1 EACH	ONE PER FORM 406	FORM 406			MANDATORY SUBMITTAL OF DOCUMENTATION FOR EACH HEAT #

MATERIAL/ MATERIAL CODE	TESTS	SAMPLE SIZE	SAMPLE/TEST FREQUENCY	FIELD	DISTRICT/ AREA LAB	MDT HQ LAB	NOTES
HIGH TENSILE STRENGTH BOLTS 711.06.00.01	STEEL CERT CATEGORY 2	1 EACH	ONE PER FORM 406	FORM 406			MANDATORY SUBMITTAL OF DOCUMENTATION PER SPECIFICATION 106.09
	MT 407 HIGH STRENGTH BOLTS	1 BOLT	ONE TEST PER LOT/BATCH	SAMPLE		TEST	
	ASTM F959 DIRECT TENSION INDICATORS	1 DTI	ONE TEST PER LOT/BATCH				

MATERIAL/ MATERIAL CODE	TESTS	SAMPLE SIZE	SAMPLE/TEST FREQUENCY	FIELD	DISTRICT/ AREA LAB	MDT HQ LAB	NOTES
GALVANIZED METAL 711.08.00.01	CERT/ VISUAL INSPECTION	1 EACH	ONE TEST PER LOT/BATCH	DATA SHEET			
	STEEL CERT CATEGORY 2	1 EACH	ONE PER FORM 406	FORM 406			MANDATORY SUBMITTAL OF DOCUMENTATION PER SPECIFICATION 106.09

STEEL

MDT MATERIALS SAMPLING, TESTING, AND ACCEPTANCE GUIDE

MT 601 (12/31/19)

STEEL

SPECIALS, SUPPLEMENTAL AND STANDARD SPECS, DETAILED DWGS

MATERIAL/ MATERIAL CODE	TESTS	SAMPLE SIZE	SAMPLE/TEST FREQUENCY	FIELD	DISTRICT/ AREA LAB	MDT HQ LAB	NOTES
WELDED STUD SHEAR CONNECTORS 711.09.00.01	CERT/ VISUAL INSPECTION	1 EACH	ONE PER SHIPMENT	DATA SHEET OR CERT OF COMP			IF WELDING OCCURS, CERTIFICATE OF COMPLIANCE IS SUBMITTAL OF DOCUMENTATION PER SPECIFICATION 624.03.3
	STEEL CERT CATEGORY 2	1 EACH	ONE PER FORM 406	FORM 406			MANDATORY SUBMITTAL OF DOCUMENTATION PER SPECIFICATION 106.09 REQUIRED ONLY IF MATERIAL HAS NOT BEEN PRE-INSPECTED
	MT 409 WELDED STUD SHEAR CONNECTORS	1 EACH	ONE PER ITEM			PRE-INSPECTION	

MATERIAL/ MATERIAL CODE	TESTS	SAMPLE SIZE	SAMPLE/TEST FREQUENCY	FIELD	DISTRICT/ AREA LAB	MDT HQ LAB	NOTES
PRESTRESSING STEEL 711.11.00.01	CERT/ VISUAL INSPECTION	1 EACH	ONE PER ITEM	DATA SHEET			
	STEEL CERT CATEGORY 2	1 EACH	ONE PER FORM 406	FORM 406			MANDATORY SUBMITTAL OF DOCUMENTATION PER SPECIFICATION 106.09
	ASTM A416 SEVEN WIRE STRAND	8 FT (3 M)	ONE TEST PER LOT	SAMPLE		TEST	

MATERIAL/ MATERIAL CODE	TESTS	SAMPLE SIZE	SAMPLE/TEST FREQUENCY	FIELD	DISTRICT/ AREA LAB	MDT HQ LAB	NOTES
MISCELLANEOUS IRON DRAINAGE CASTINGS 711.12.03.01	CERT/ VISUAL INSPECTION	1 EACH	ONE PER LOT/ITEM	DATA SHEET			
	STEEL CERT CATEGORY 2	1 EACH	ONE PER FORM 406	FORM 406			MANDATORY SUBMITTAL OF DOCUMENTATION PER SPECIFICATION 106.09

MATERIAL/ MATERIAL CODE	TESTS	SAMPLE SIZE	SAMPLE/TEST FREQUENCY	FIELD	DISTRICT/ AREA LAB	MDT HQ LAB	NOTES
CAST IRON INLET FRAME & GRATES 711.12.03.02	CERT/ VISUAL INSPECTION	1 EACH	ONE PER LOT/ITEM	DATA SHEET			ACCEPTANCE ONLY FROM THE QUALIFIED PRODUCTS LIST
	STEEL CERT CATEGORY 2	1 EACH	ONE PER FORM 406	FORM 406			

STEEL

MDT MATERIALS SAMPLING, TESTING, AND ACCEPTANCE GUIDE

MT 601 (12/31/19)

STEEL

SPECIALS, SUPPLEMENTAL AND STANDARD SPECS, DETAILED DWGS

MATERIAL/ MATERIAL CODE	TESTS	SAMPLE SIZE	SAMPLE/TEST FREQUENCY	FIELD	DISTRICT/ AREA LAB	MDT HQ LAB	NOTES
STRUCTURAL ANCHOR BOLTS 711.13.00.01	CERT/ VISUAL INSPECTION	1 EACH	ONE PER ITEM	DATA SHEET			
	STEEL CERT CATEGORY 2	1 EACH	ONE PER FORM 406	FORM 406			MANDATORY SUBMITTAL OF DOCUMENTATION PER SPECIFICATION 106.09

MATERIAL/ MATERIAL CODE	TESTS	SAMPLE SIZE	SAMPLE/TEST FREQUENCY	FIELD	DISTRICT/ AREA LAB	MDT HQ LAB	NOTES
MECHANICAL REBAR CONNECTORS 711.18.00.01	CERT/ VISUAL INSPECTION	1 EACH	ONE PER SHIPMENT	DATA SHEET			
	STEEL CERT CATEGORY 2	1 EACH	ONE PER FORM 406	FORM 406			MANDATORY SUBMITTAL OF DOCUMENTATION PER SPECIFICATION 106.09

MATERIAL/ MATERIAL CODE	TESTS	SAMPLE SIZE	SAMPLE/TEST FREQUENCY	FIELD	DISTRICT/ AREA LAB	MDT HQ LAB	NOTES
HIGH STRENGTH WIRE ROCKFALL MESH 711.21.00.01	CERT/ VISUAL INSPECTION	1 EACH	ONE PER LOT/ITEM	DATA SHEET			
	STEEL CERT CATEGORY 2	1 EACH	ONE PER FORM 406	FORM 406			MANDATORY SUBMITTAL OF DOCUMENTATION PER SPECIFICATION 106.09

MATERIAL/ MATERIAL CODE	TESTS	SAMPLE SIZE	SAMPLE/TEST FREQUENCY	FIELD	DISTRICT/ AREA LAB	MDT HQ LAB	NOTES
GABION BASKETS - WIRE AND WIRE MESH 711.21.00.02	CERT/ VISUAL INSPECTION	1 EACH	ONE PER LOT/ITEM	DATA SHEET OR CERT OF COMP			
	STEEL CERT CATEGORY 2	1 EACH	ONE PER FORM 406	FORM 406			MANDATORY SUBMITTAL OF DOCUMENTATION PER SPECIFICATION 106.09

STEEL

STREAM PRESERVATION

SPECIALS, SUPPLEMENTAL AND STANDARD SPECS, DETAILED DWGS

MATERIAL/ MATERIAL CODE	TESTS	SAMPLE SIZE	SAMPLE/TEST FREQUENCY	FIELD	DISTRICT/ AREA LAB	MDT HQ LAB	NOTES
TEMPORARY ROLLED EROSION CONTROL 208.02.00.01	CERT/ VISUAL INSPECTION	1 EACH	ONE PER ITEM	CERT OF COMP OR DATA SHEET			CERTIFICATE OF COMPLIANCE IS REQUIRED FOR ALL EROSION CONTROL THAT CONTAINS STRAW

MATERIAL/ MATERIAL CODE	TESTS	SAMPLE SIZE	SAMPLE/TEST FREQUENCY	FIELD	DISTRICT/ AREA LAB	MDT HQ LAB	NOTES
TEMPORARY SEED 208.02.00.02	CERT/ VISUAL INSPECTION	1 EACH	ONE PER LOT/BATCH	DATA SHEET			VERIFY ITEM MEETS MDT REQUIREMENTS AND ATTACH APPLICABLE CERT

MATERIAL/ MATERIAL CODE	TESTS	SAMPLE SIZE	SAMPLE/TEST FREQUENCY	FIELD	DISTRICT/ AREA LAB	MDT HQ LAB	NOTES
STREAM PRESERVATION MATERIALS 208.02.00.03	CERT/ VISUAL INSPECTION	N/A	ONE PER ITEM	VISUAL			VERIFY ITEM MEETS MDT REQUIREMENTS

MATERIAL/ MATERIAL CODE	TESTS	SAMPLE SIZE	SAMPLE/TEST FREQUENCY	FIELD	DISTRICT/ AREA LAB	MDT HQ LAB	NOTES
STREAMBED AGGREGATE 208.02.03.01	CERT/ VISUAL INSPECTION	N/A	ONE PER MATERIAL TYPE	VISUAL			VERIFY ITEM MEETS MDT REQUIREMENTS
	MT 201 SAMPLING	SAMPLE PER MT 201	ONE PER SOURCE	SAMPLE			
	MT 202 SIEVE ANALYSIS			TEST			

MDT MATERIALS SAMPLING, TESTING, AND ACCEPTANCE GUIDE
BUILDING MATERIALS

MT 601 (12/31/19)

STRUCTURE MATERIAL

SPECIALS, SUPPLEMENTAL AND STANDARD SPECS, DETAILED DWGS

MATERIAL/ MATERIAL CODE	TESTS	SAMPLE SIZE	SAMPLE/TEST FREQUENCY	FIELD	DISTRICT/ AREA LAB	MDT HQ LAB	NOTES
BIRD SPIKES BM.699.01.01	CERT/ VISUAL INSPECTION	1 EACH	ONE PER EACH TYPE	VISUAL			
GLUE LAMINATED BEAMS BM.699.01.02	CERT/ VISUAL INSPECTION	1 EACH	ONE PER BEAM	DATA SHEET			
INSULATION BM.699.01.03	CERT/ VISUAL INSPECTION	1 EACH	ONE PER EACH	DATA SHEET			
METAL ROOFING BM.699.01.04	CERT/ VISUAL INSPECTION	1 EACH	ONE PER EACH	DATA SHEET			
	STEEL CERT CATEGORY 2	1 EACH	ONE PER FORM 406	FORM 406			MANDATORY SUBMITTAL OF DOCUMENTATION PER SPECIFICATION 106.09
METAL SIDING & SOFFIT BM.699.01.05	CERT/ VISUAL INSPECTION	1 EACH	ONE PER EACH	DATA SHEET			
	STEEL CERT CATEGORY 2	1 EACH	ONE PER FORM 406	FORM 406			MANDATORY SUBMITTAL OF DOCUMENTATION PER SPECIFICATION 106.09

BUILDING MATERIALS

**MDT MATERIALS SAMPLING, TESTING, AND ACCEPTANCE GUIDE
BUILDING MATERIALS**

MT 601 (12/31/19)

STRUCTURE MATERIAL

SPECIALS, SUPPLEMENTAL AND STANDARD SPECS, DETAILED DWGS

MATERIAL/ MATERIAL CODE	TESTS	SAMPLE SIZE	SAMPLE/TEST FREQUENCY	FIELD	DISTRICT/ AREA LAB	MDT HQ LAB	NOTES
PICNIC SHELTER (NON PRECAST) BM.699.01.06	CERT/ VISUAL INSPECTION	1 EACH	ONE PER EACH	DATA SHEET			

MATERIAL/ MATERIAL CODE	TESTS	SAMPLE SIZE	SAMPLE/TEST FREQUENCY	FIELD	DISTRICT/ AREA LAB	MDT HQ LAB	NOTES
QUARRY TILE BM.699.01.07	CERT/ VISUAL INSPECTION	1 EACH	ONE PER EACH	DATA SHEET			

MATERIAL/ MATERIAL CODE	TESTS	SAMPLE SIZE	SAMPLE/TEST FREQUENCY	FIELD	DISTRICT/ AREA LAB	MDT HQ LAB	NOTES
ROOF JOIST BM.699.01.08	CERT/ VISUAL INSPECTION	1 EACH	ONE PER EACH	DATA SHEET			
	STEEL CERT CATEGORY 2	1 EACH	ONE PER FORM 406	FORM 406			MANDATORY SUBMITTAL OF DOCUMENTATION PER SPECIFICATION 106.09

MATERIAL/ MATERIAL CODE	TESTS	SAMPLE SIZE	SAMPLE/TEST FREQUENCY	FIELD	DISTRICT/ AREA LAB	MDT HQ LAB	NOTES
INTERIOR/ EXTERIOR BUILDING TAPE & PAINT BM.699.01.09	CERT/ VISUAL INSPECTION	1 EACH	ONE PER EACH	DATA SHEET			

BUILDING MATERIALS

**MDT MATERIALS SAMPLING, TESTING, AND ACCEPTANCE GUIDE
BUILDING MATERIALS**

MT 601 (12/31/19)

STRUCTURE MATERIAL

SPECIALS, SUPPLEMENTAL AND STANDARD SPECS, DETAILED DWGS

MATERIAL/ MATERIAL CODE	TESTS	SAMPLE SIZE	SAMPLE/TEST FREQUENCY	FIELD	DISTRICT/ AREA LAB	MDT HQ LAB	NOTES
MASONARY/ THROUGH WALL FLASHING BM.699.01.10	CERT/ VISUAL INSPECTION	1 EACH	ONE PER EACH	VISUAL			
MATERIAL/ MATERIAL CODE	TESTS	SAMPLE SIZE	SAMPLE/TEST FREQUENCY	FIELD	DISTRICT/ AREA LAB	MDT HQ LAB	NOTES
PRE-PACKAGED MORTAR BM.699.01.11	CERT/ VISUAL INSPECTION	1 EACH	ONE PER PROJECT, PER TYPE	DATA SHEET			
MATERIAL/ MATERIAL CODE	TESTS	SAMPLE SIZE	SAMPLE/TEST FREQUENCY	FIELD	DISTRICT/ AREA LAB	MDT HQ LAB	NOTES
MASONRY SIDING BM.699.01.14	CERT/ VISUAL INSPECTION	1 EACH	ONE PER PROJECT, PER TYPE	DATA SHEET			
MATERIAL/ MATERIAL CODE	TESTS	SAMPLE SIZE	SAMPLE/TEST FREQUENCY	FIELD	DISTRICT/ AREA LAB	MDT HQ LAB	NOTES
INTERIOR/ EXTERIOR GLASS AND GLAZING BM.699.01.15	CERT/ VISUAL INSPECTION	1 EACH	ONE PER EACH	DATA SHEET			

BUILDING MATERIALS

**MDT MATERIALS SAMPLING, TESTING, AND ACCEPTANCE GUIDE
BUILDING MATERIALS**

MT 601 (12/31/19)

ELECTRICAL/MECHANICAL

SPECIALS, SUPPLEMENTAL AND STANDARD SPECS, DETAILED DWGS

MATERIAL/ MATERIAL CODE	TESTS	SAMPLE SIZE	SAMPLE/TEST FREQUENCY	FIELD	DISTRICT/ AREA LAB	MDT HQ LAB	NOTES
ELECTRICAL BM.699.02.01	CERT/ VISUAL INSPECTION	1 EACH	ONE PER EACH	DATA SHEET			

MATERIAL/ MATERIAL CODE	TESTS	SAMPLE SIZE	SAMPLE/TEST FREQUENCY	FIELD	DISTRICT/ AREA LAB	MDT HQ LAB	NOTES
HVAC SYSTEM BM.699.02.02	CERT/ VISUAL INSPECTION	1 EACH	ONE PER EACH COMPONENT, PER TYPE, PER PROJECT	DATA SHEET			

MATERIAL/ MATERIAL CODE	TESTS	SAMPLE SIZE	SAMPLE/TEST FREQUENCY	FIELD	DISTRICT/ AREA LAB	MDT HQ LAB	NOTES
INTERIOR FIXTURES & FEATURES BM.699.02.03	CERT/ VISUAL INSPECTION	1 EACH	ONE PER EACH	VISUAL			

MATERIAL/ MATERIAL CODE	TESTS	SAMPLE SIZE	SAMPLE/TEST FREQUENCY	FIELD	DISTRICT/ AREA LAB	MDT HQ LAB	NOTES
PROPANE TANK BM.699.02.04	CERT/ VISUAL INSPECTION	1 EACH	ONE PER EACH	DATA SHEET			
	STEEL CERT CATEGORY 2	1 EACH	ONE PER FORM 406	FORM 406			MANDATORY SUBMITTAL OF DOCUMENTATION PER SPECIFICATION 106.09

**MDT MATERIALS SAMPLING, TESTING, AND ACCEPTANCE GUIDE
BUILDING MATERIALS**

MT 601 (12/31/19)

PLUMBING

SPECIALS, SUPPLEMENTAL AND STANDARD SPECS, DETAILED DWGS

MATERIAL/ MATERIAL CODE	TESTS	SAMPLE SIZE	SAMPLE/TEST FREQUENCY	FIELD	DISTRICT/ AREA LAB	MDT HQ LAB	NOTES
IRRIGATION SYSTEM BM.699.03.01	CERT/ VISUAL INSPECTION	1 EACH	ONE PER EACH	DATA SHEET			
PLUMBING BM.699.03.02	CERT/ VISUAL INSPECTION	1 EACH	ONE PER EACH	DATA SHEET			
WASTE WATER TREATMENT SYSTEM BM.699.03.03	CERT/ VISUAL INSPECTION	1 EACH	ONE PER EACH	DATA SHEET			
WASTE WATER UTILITY PIPE & APPURTENANCE BM.699.03.04	CERT/ VISUAL INSPECTION	1 EACH	ONE PER EACH	DATA SHEET			
WASTE WATER PUMPS, FITTINGS & VALVES BM.699.03.05	CERT/ VISUAL INSPECTION	1 EACH	ONE PER EACH	DATA SHEET			
WELL PUMPS, FITTINGS & VALVES BM.699.03.07	CERT/ VISUAL INSPECTION	1 EACH	ONE PER EACH	DATA SHEET			

BUILDING MATERIALS

**MDT MATERIALS SAMPLING, TESTING, AND ACCEPTANCE GUIDE
BUILDING MATERIALS**

MT 601 (12/31/19)

ACCESSORIES

SPECIALS, SUPPLEMENTAL AND STANDARD SPECS, DETAILED DWGS

MATERIAL/ MATERIAL CODE	TESTS	SAMPLE SIZE	SAMPLE/TEST FREQUENCY	FIELD	DISTRICT/ AREA LAB	MDT HQ LAB	NOTES
BENCHES (NON PRECAST) BM.699.04.01	CERT/ VISUAL INSPECTION	1 EACH	ONE PER EACH	DATA SHEET			
PICNIC TABLES (NON PRECAST) BM.699.04.02	CERT/ VISUAL INSPECTION	1 EACH	ONE PER EACH	DATA SHEET			
TRASH RECEPTACLES (NON PRECAST) BM.699.04.03	CERT/ VISUAL INSPECTION	1 EACH	ONE PER EACH	DATA SHEET			
FIRE EXTINGUISHERS & CABINETS BM.699.04.04	CERT/ VISUAL INSPECTION	1 EACH	ONE PER EACH	DATA SHEET			
FLAG POLES (ALUMINUM) BM.699.04.05	CERT/ VISUAL INSPECTION	1 EACH	ONE PER EACH	DATA SHEET			
TOILET ROOM ACCESSORIES BM.699.04.06	CERT/ VISUAL INSPECTION	1 EACH	ONE PER EACH	VISUAL			

BUILDING MATERIALS

**MDT MATERIALS SAMPLING, TESTING, AND ACCEPTANCE GUIDE
BUILDING MATERIALS**

MT 601 (12/31/19)

DOOR/DISPLAY

SPECIALS, SUPPLEMENTAL AND STANDARD SPECS, DETAILED DWGS

MATERIAL/ MATERIAL CODE	TESTS	SAMPLE SIZE	SAMPLE/TEST FREQUENCY	FIELD	DISTRICT/ AREA LAB	MDT HQ LAB	NOTES
ALUMINUM STOREFRONT BM.699.05.01	CERT/ VISUAL INSPECTION	1 EACH	ONE PER EACH	DATA SHEET			
DISPLAY CASES BM.699.05.02	CERT/ VISUAL INSPECTION	1 EACH	ONE PER EACH	DATA SHEET			
HOLLOW METAL DOORS & FRAMES BM.699.05.03	CERT/ VISUAL INSPECTION	1 EACH	ONE PER EACH	VISUAL			
OVERHEAD GARAGE DOORS BM.699.05.04	CERT/ VISUAL INSPECTION	1 EACH	ONE PER EACH	DATA SHEET			

BUILDING MATERIALS

**MDT MATERIALS SAMPLING, TESTING, AND ACCEPTANCE GUIDE
BUILDING MATERIALS**

MT 601 (12/31/19)

SCALE SITE SPECIFIC

SPECIALS, SUPPLEMENTAL AND STANDARD SPECS, DETAILED DWGS

MATERIAL/ MATERIAL CODE	TESTS	SAMPLE SIZE	SAMPLE/TEST FREQUENCY	FIELD	DISTRICT/ AREA LAB	MDT HQ LAB	NOTES
SCALE PIT STRUCTURAL ITEMS BM.699.06.01	CERT/ VISUAL INSPECTION	1 EACH	ONE PER EACH	DATA SHEET			IF MATERIAL IS STEEL OR PRECAST, A STEEL CERT IS REQUIRED
	STEEL CERT CATEGORY 2	1 EACH	ONE PER FORM 406	FORM 406			MANDATORY SUBMITTAL OF DOCUMENTATION PER SPECIFICATION 106.09

MATERIAL/ MATERIAL CODE	TESTS	SAMPLE SIZE	SAMPLE/TEST FREQUENCY	FIELD	DISTRICT/ AREA LAB	MDT HQ LAB	NOTES
SCALE ELECTRONICS, TRANSDUCERS, AND DISPLAYS BM.699.06.02	CERT/ VISUAL INSPECTION	1 EACH	ONE PER EACH	DATA SHEET			

METHODS OF SAMPLING AND TESTING**MT 602-17****ACCEPTANCE, INDEPENDENT ASSURANCE AND FINAL RECORD SAMPLING****1 SCOPE**

- 1.1 Samples are to be obtained on a random basis for materials specified in MT 601 and in specified quantities as related to yards, tons or other units of measurement.

This test method documents the use of and the rates and frequencies associated with the acceptance of samples, independent assurance of procedures, and final records.

Classes of Samples and Tests: Three classes of samples and tests are required for each project. They are "Acceptance samples and tests," "Independent Assurance samples and tests," and "Final Record samples and tests."

2 REFERENCE DOCUMENTS***ASTM***

D5821 Determining the Percentage of Fractured Particles in Coarse Aggregate

AASHTO

T 89 Determining the Liquid Limit of Soils

T 90 Determining the Plastic Limit and Plasticity Index of Soils

T 335 Determining the Percentage of Fracture in Coarse Aggregate

MT Materials Manual

MT 202 Sieve Analysis for Fine and Coarse Aggregate

MT 226 Maximum Acceptable Deviations in Sieve Analysis of IA Samples

MT 601 Materials Sampling, Testing and Acceptance Guide

MT 606 Random Sampling Techniques

3 ACCEPTANCE SAMPLING AND TESTING

Random sampling and testing in accordance with MT 601 to ensure the quality of materials being incorporated or proposed for incorporation into a construction project. Acceptance sampling and testing are the principal means to assure materials and workmanship are in accordance with the contract. The number of samples and the distribution of the locations from which they are taken should be such as to ensure the materials incorporated are acceptable and in accordance with the contract requirements. Sampling and testing frequencies listed are a minimum. As job conditions vary, such as the uniformity of materials at the source, the methods and equipment used, and weather conditions, further sampling and testing can be done. Acceptance sampling and testing may be any of the following:

- Samples of materials witnessed, taken and/or tested by MDT personnel or delegated inspection agency.
- Samples taken and/or tested by the manufacturer or supplier with test results or certificates submitted to the Department.

4 INDEPENDENT ASSURANCE (IA)

Per 23 CFR 637, Independent Assurance Program is defined as activities that are an unbiased and independent evaluation of all the sampling and testing procedures used in the acceptance program. IA results are not used directly for determining the quality and acceptability of the materials and workmanship on a project, but serve as checks on the reliability of the results obtained in project acceptance sampling and testing.

The elements of the Department's IA Program are as follows:

- IA sampling and testing frequencies as established in MT 601
- Prompt comparison and documentation of test results obtained from split sample and

- proficiency sample evaluations
- Department established tolerances for the comparison of test results
- Evaluation of testing personnel procedures through observations and results of split samples and proficiency samples
- Testing equipment evaluation using calibration checks, split samples and proficiency samples

4.1 Independent Assurance Comparison (IAC)

Description – IAC tests (also known as split samples) are performed to verify conformance with testing criteria through review of test results on equivalent samples.

Purpose – IAC's are used to eliminate materials and sampling variability from the analysis so only the variability due to the testing procedures and the equipment are evaluated.

Frequency – MT 601 lists the minimum frequencies at which Independent Assurance Comparison samples are taken. These are reviewed and approved by the FHWA.

Responsibility – IAC's are a joint effort between Field Construction technicians, District/Area Materials Lab technicians, and MDT Materials Headquarter technicians. IAC requirements apply to all persons conducting acceptance sampling and testing on behalf of MDT.

Sampling – These samples are taken at random per MT 606 from materials or from construction work in progress and are not necessarily intended to check compliance with specifications. They are taken and tested to provide an independent spot check of the adequacy and effectiveness of the results obtained in acceptance sampling and testing. If differences are discovered between acceptance samples and Independent assurance samples, it must be determined immediately why deviations exist and corrective measures taken to assure proper testing techniques and equipment are being utilized. If independent assurance samples are to accomplish the purpose for which they are intended, they must be the same sample or taken at the same place, by the same method and at the same time as routine acceptance samples.

When an IAC sample is required, the technician performing acceptance testing obtains a sample, performs the initial acceptance test and documents the results. This sample then becomes the IAC sample that will be tested by the District/Area Materials Lab technician or MDT Materials Headquarters technician or both. To maintain the integrity of the sample, it is critical that all materials used for testing (with the exception of the wash sample) be recombined to their original configuration prior to transferring to the next testing facility.

Sampling concrete aggregate shall be done by the District Laboratory Supervisor or a designated representative.

Independent assurance samples are selected by MDT personnel who are not associated with the taking of acceptance samples on the project, or from samples taken for acceptance purposes provided such samples have been taken under their observation and control. Independent assurance samples are to be continuously in the custody or under the observation of properly trained personnel not associated with acceptance sampling until they are shipped or delivered to the District/Area Laboratory or the Materials Bureau for testing.

Testing IAC Samples – The IAC sample must be taken to the laboratory and tested without delay. The results obtained for each of the required tests are to be delivered promptly to the Project Manager. Results should be compared with acceptance test results obtained on similar material and an evaluation made as to the accuracy of the acceptance sampling and testing. Project personnel should be notified if improved procedures, closer inspection and control, or possible corrective action are required.

Controlling test results – IAC results are not used directly for determining the quality and acceptability of the materials on a project. Acceptance test results take precedence in the event of conflicting results unless extenuating circumstances are identified.

Tolerance – Department IAC tolerances are identified per the following table:

MATERIAL CATEGORY	TEST METHOD	REFERENCE DOCUMENT	TOLERANCE
AGGREGATE	MT 202 SIEVE ANALYSIS	MT 226	REFER TO MT 226 FOR ACCEPTABLE DEVIATION
AGGREGATE SURFACING	MT 202 SIEVE ANALYSIS	MT 226	REFER TO MT 226 FOR ACCEPTABLE DEVIATION
AGGREGATE SURFACING	AASHTO T 89	N/A	MULTILABORATORY RESULTS DIFFER BY MORE THAN 13% OF THEIR MEAN
AGGREGATE SURFACING	AASHTO T 90	N/A	MULTILABORATORY RESULTS DIFFER BY MORE THAN 18% OF THEIR MEAN
AGGREGATE SURFACING	AASHTO T 335	ASTM D5821	MULTILABORATORY RESULTS DIFFER BY MORE THAN 14.7% OF THEIR MEAN

IAC results that are considered unsatisfactory must be investigated by the appropriate District Materials Supervisor to identify the cause and any corrective action needed. Document corrective action taken for the project file with copies sent to the Inspection Operations Supervisor. Unsatisfactory IACs should be brought to the attention of the corresponding Project Manager. Failure to demonstrate the following are typical causes of an unsatisfactory IAC.

- Test results within the tolerance
- Proper equipment to conduct sampling and testing
- Equipment properly calibrated and in good working order
- Sampling and testing conducted according to prescribed MT methods
- Willingness to participate in an IAC (Indicate refusal in remarks section of the IAC report)

Every effort should be made to correct equipment or procedural problems immediately. A follow-up IAC investigation must be initiated within five working days to ensure that equipment and procedures are satisfactory. The IAC must be repeated until the problem is corrected and a satisfactory IAC is completed.

Reporting – Results of IAC's including corrective action is recorded in SiteManager.

4.2 Independent Assurance Procedural (IAP)

Description – IAP checks are performed to verify conformance with contract standards and testing criteria through review of test procedures. The IAP will be conducted on the jobsite while the tester is in the process of running normal acceptance testing for job control.

Purpose – A key part of the IAP is witnessing the sampling and testing to verify that proper procedures are being followed. The calibration and condition of sampling and testing equipment used should be carefully checked.

Frequency – The frequencies at which IAP checks are performed should conform in general to MT 601. These frequencies have been reviewed and approved by the FHWA. Rigid conformity with a frequency pattern established as a guide for general application is not expected. In general, the given frequencies are set at a minimum. Each IAP assessment performed on a project may fulfill the same IAP requirement for other projects when performed by the same technician within 30 days.

Responsibility – IAP's are a joint effort between the District/Area Materials Lab Supervisors, Area Lab Coordinators, District and Area Lab Technicians and MDT Materials Headquarter personnel. IAP requirements apply to all persons conducting acceptance sampling and testing on behalf of MDT. IAP's must be performed by personnel not normally involved in the acceptance testing for the project.

Acceptability – IAP results that are considered unsatisfactory must be investigated by the appropriate District Materials Supervisor or MDT Materials Headquarter personnel to identify the cause and corrective action needed. Document any corrective action for the project file with copies sent to the Inspection Operations Supervisor. Unsatisfactory IAP's should be brought to the attention of the corresponding Project Manager. Failure to demonstrate the following are typical causes of an unsatisfactory IAP.

- Proper equipment to conduct sampling and testing
- Equipment properly calibrated and in good working order
- Sampling and testing conducted according to prescribed MT methods
- Willingness to participate in an IAC (Indicate refusal in the remarks section of the IAP report)

The personnel proctoring the IAP will explain to the tester why the test was unsatisfactory and how it needs to be corrected. Every effort should be made to correct equipment or procedural problems at this time. The IAP should then be repeated until the problem is corrected and a satisfactory IAP is completed. If a satisfactory IAP cannot be achieved due to tester deficiencies, notification and documentation will be provided to the WAQTC coordinator and additional training or revocation of certification may be required.

Reporting – Results of IAC's, including corrective action, is recorded in SiteManager.

4.3 Proficiency Samples

Description – Proficiency testing is an outline designed to test accuracy of District/Area Laboratories and MDT Materials Headquarter Laboratories.

Purpose – Laboratories can judge their testing results by comparing them to a large body of results performed on the same material. The quality of test results can be demonstrated, thereby reducing the risk of disputes due to testing errors. The program also provides laboratories with the means to check both the testing apparatus and the operator under actual testing conditions.

Processing Material and Sample Distribution – Homogeneity of samples is controlled during the production process. Materials are selected from known sources and are inspected when received. The materials are thoroughly blended in accordance with established schemes. The sample is then reduced for the multiple-testing process.

Frequency – Proficiency samples are distributed to participants once per year, with a pair of unique samples provided each time. When testing is complete, laboratories submit their testing results for analysis.

Tests – Proficiency tests are performed on the following procedures:

- AASHTO T 85 Specific Gravity and Absorption of Coarse Aggregate
- AASHTO T 89 Determining the Liquid Limit of Soils
- AASHTO T 90 Determining the Plastic Limit & Plasticity Index of Soils
- AASHTO T 166 Bulk Specific Gravity (Gmb) of Compacted Hot Mix Asphalt (HMA) Using Saturated Surface-Dry Specimens
- AASHTO T 335 Determining the Percentage of Fracture in Coarse Aggregate
- MT 202 Sieve Analysis of Fine and Coarse Aggregate
- MT 210 Proctor (5.5 LB)
- MT 230 Proctor (10 LB)
- MT 305 Volume Swell of Bituminous Mixtures – Caliper Method
- MT 319 Asphalt Binder Content of Hot Mix Asphalt (HMA) by Ignition Method
- MT 320 Mechanical Analysis of Aggregate Recovered from Ignition Oven Burn
- MT 321 Determining Maximum Specific Gravity of Bituminous Paving Mixtures – “Rice Method”
- MT 332 Gyrotory Compaction of Bituminous Mixtures

Responsibility – The Inspection Operations Unit of the Physical Testing Section is responsible for composition, distribution, analysis and reporting of proficiency samples.

Reporting – When an individual laboratory completes the proficiency sample testing, the technician reports results to the Inspection Operations Unit. Results from all laboratories are then compiled and reports are distributed to each individual laboratory. If corrective actions are required, a notification will be sent out by the Inspection Operations Unit to laboratories with deficient results. The District Material Laboratory Supervisor is responsible for responding to the deficiency.

4.4 Lab and Equipment Inspections

Description – The Physical Testing Section conducts annual inspections on District, Area, and MDT Materials Headquarters Laboratories and equipment used for acceptance testing.

Purpose – Laboratory and equipment inspections are performed to demonstrate competency in the performance of specific test procedures and that testing equipment is within procedural requirements.

Frequency – Equipment and procedural inspections are performed annually.

Responsibility – The Inspection Operations Unit conducts and reports procedural inspections performed in District and Area Laboratories. MDT Materials Headquarters Laboratory Supervisors conduct procedural inspections on technicians performing testing under their supervision. Equipment calibrations and verifications are a joint effort between the Inspection Operations Unit and MDT Materials Laboratory Supervisors.

Reporting – Procedures observed by the Inspection Operations personnel are entered into SiteManager and summarized in a hard copy report that is sent to the District Administrator and Materials Bureau Engineer. Equipment calibrations and verifications are entered into SiteManager by the applicable Materials Laboratory Supervisor or a designated representative. Each laboratory is responsible for sustaining up to date calibration/verification of testing equipment. An equipment status report may be generated by Oracle.

5 FINAL RECORD (FR)

Description – FR samples are physical comparisons between design plan dimensions and those actually achieved during construction.

Purpose – FR core samples are taken and analyzed for the following purposes:

- To determine adequacy of pavement thickness and other construction requirements but not for the purpose of checking compliance with specification requirements. These samples are taken to verify conformity with plans and specification requirements applicable to the completed construction.
-
- To furnish information relative to the amounts of change in properties of the material used in the work. FR samples and tests are for physical research purposes to ascertain the need and basis for possible improvements in future designs and specifications.
-
- To determine if corrective measures may be necessary. FR samples and tests serve to indicate whether previously unknown or unsuspected conditions may exist on the project that may have a detrimental effect on the completed construction.

Frequency of Sampling – The frequency of FR samples is stated in MT 601.

Responsibility – Samples must be witnessed by or under the direct supervision of the District/Area Lab Supervisor or their designated representative and must not be scheduled on such an inflexible and regular routine that its frequency can be predicted. Sufficient samples must be submitted to satisfy the frequency intended.

Sampling and Testing – These samples are taken at random per MT 606 from completed construction work or completed portions thereof.

FR samples should be taken at each individual stage of the construction work as it is completed and before it is covered or disturbed by a subsequent construction stage. This minimizes damage to finished work and facilitates the satisfactory procurement of samples. FR core sample locations will be referenced to centerline.

Whenever test results indicate that significant changes have occurred (because of processing, contamination, or other reasons, after the materials were incorporated into the construction), these changes should be reported with an explanation.

Reporting – Results of FR samples including corrective action are recorded in SiteManager.

METHODS OF SAMPLING AND TESTING
MT 603-16
DEFINITIONS

1. SOIL ENGINEERING TERMS

Dust Ratio – The ratio of the portion passing the 200 mesh sieve to the portion passing the 40-mesh sieve and shall be no greater than two-thirds.

Degradation Value – A specification set for each project using aggregate and is defined as a value from 100 to 0 indicating the quality of fines produced by self-abrasion of aggregate in the presence of water. (100 is superior and below 35 is poor).

Gradation – A term used to describe the range and the relative distribution of particle sizes in a material.

Well-graded soils – Those soils, which have a good representation of all particle sizes from the largest to the smallest but with a very small percentage of fines.

Poorly-graded soils – Those soils in which the range of particle sizes is very small or soils having a deficiency in some of the intermediate sizes or soils containing excessive fines.

Liquid Limit – The moisture content, which is the boundary between the liquid and plastic states for the minus No. 40 fraction of a soil. For laboratory purposes it may be defined as the moisture content at which that soil fraction will close a standard groove for a length of 1/2 inch when subjected to 25 blows in a liquid limit device.

Moisture Content – The weight of water in a given soil mass divided by the oven dry weight of the soil and is expressed in percent.

Optimum Moisture – The moisture content, which will permit maximum-dry-unit weight to be obtained for a given comp active effort.

Plastic Limit – The moisture content, which is the boundary between the plastic and semi-solid states for the minus No. 40 fraction of the soil. For laboratory purposes, it may be defined as the minimum moisture content at which the soil fraction can be rolled into a thread 1/8 inch in diameter without crumbling.

Plastic Index – The numerical difference between the moisture content of the Liquid Limit and the moisture content of the Plastic Limit.

R-Value – The resistance value (R-value) test is a material stiffness test. The test procedure expresses a materials resistance to deformation as a function of the ratio of transmitted lateral pressure to applied vertical pressure. R-value is expressed as a numerical value from 0 to 100 with 0 being easily deformed by light loads. R-value, along with traffic volumes, are used in the pavement design process to determine the proper surfacing structure for a given project.

Wear Value – A specification set for each project using aggregate and is defined as the percentage of dry weight lost during the abrasion of coarse aggregate in a Los Angeles Machine with an abrasive charge.

2. DENSITY

Absolute (of solids and liquids) – The mass of a unit volume of a material at a specified temperature (grams per milliliter, grams per cubic centimeter, pounds per cubic foot, etc. at x temperature).

Absolute (of gases) – The mass of a unit volume of a gas at a stated temperature and pressure (grams per milliliter, grams per cubic centimeter, pounds per cubic foot, etc. at x temperature, y pressure).

Apparent (of solids and liquids) – The weight in air of a unit volume of a material at a specified temperature.

Bulk (of solids) – The weight in air of a unit volume of a permeable material (including both permeable and impermeable voids normal to the material) at a stated temperature.

3. SPECIFIC GRAVITY TERMS

Absolute – The ratio of the weight of a given volume of solids to the weight of an equal volume of water at a stated temperature.

Apparent – The ratio of the weight of a given volume of impermeable material (the solid matter including impermeable pores) to the weight of an equal volume of water.

Bulk – The ratio of the weight of a given volume of permeable material (including both permeable and impermeable voids) to the weight of an equal volume of water.

Permeability – A measure of the facility of a soil to transmit liquids, largely dependent upon grain size distribution.

“Rice” Gravity – Defined as the maximum specific gravity (absolute) of the uncompacted bituminous mixture.

4. HIGHWAY TERMS

Base – Foundation for pavement.

Base Course – A term used to include the layers of relatively high quality materials placed above the sub-grade as a stress distribution medium to insure that the stress induced in the sub-grade will not exceed its strength.

Binder Course – The course, in sheet asphalt and bituminous concrete pavements, placed between base and surface courses.

Bleeding – The upward migration of bituminous material resulting in a film of bitumen on the surface.

Blow-Up – Localized buckling or shattering of rigid pavement caused by excessive longitudinal pressure.

Cement Treated Base (CTB) – A mixture of a well graded aggregate and measured amounts of Portland cement and water, compacted to a high density to provide a durable base for paving.

Construction Joint – The vertical or notched plane of separation in pavement.

Contraction Joint – A full depth or weakened plane type joint designed to establish the position of any crack caused by contraction while providing no space for expansion of the pavement beyond its original length.

Corrugations – The regular transverse undulations in a pavement surface consisting of alternate valleys and crests.

Cracks – The approximately vertical cleavage due to natural causes or traffic action.

Crazing – A pattern of cracking extending only through the surface layer, a result of more drying shrinkage in the surface than the interior of plastic concrete.

“D” Lines – Disintegration characterized by successive formation of a series of fine cracks at rather close intervals paralleling edges, joints and cracks and usually curving across slab corners, initial cracks forming very close to slab edges and additional cracks progressively developing, ordinarily filled with calcareous deposits.

Disintegration – Deterioration into small fragments from any cause.

Distortion – Any deviation of pavement surface from the original shape.

Expansion Joints – A joint permitting the pavement to expand in length.

Faulting – The differential vertical displacement of slabs adjacent to joints or cracks.

Flecking – The dislodgement of a thin film of mortar from the outermost portion of occasional coarse aggregate particles on concrete surfaces, generally attributable to lack of bond between mortar and aggregate.

Flexible Base and Pavements – A bituminous pavement consisting of a well-graded aggregate combined with asphalt cement and with sufficiently low bending resistance to maintain intimate contact with the underlying structure and to distribute loads to the foundation by aggregate interlock, particle friction, or surface tension. Principle elements of flexible pavements are wearing surface, base, sub-base and sub-grades.

Frost Heave – The lifting and distortion of a surface due to internal action of frost resulting from subsurface ice formation; affects soil, rock, pavement, and other structures.

Joints – Constructed junctions between adjacent sections of pavement or between pavement and structures.

Leveling Course – A course of variable thickness constructed immediately on top of base material or existing pavement to remove large irregularities prior to super-imposed treatment or construction. (Binder course may function as leveling course and be called Binder course, Leveling course or Binder-Leveling course).

Longitudinal Joint – Either a full depth or weakened-plane type joint constructed parallel to or along the centerline to control longitudinal cracking.

Map Cracking – Disintegration in which cracking of the slab surface develops in a random pattern; may develop over the entire surface or localized areas.

Pitting – The displacement of aggregate particles from the pavement surface due to the action of traffic or disintegration, without major displacement of cementing material.

Plane of Failure – The depth at which the voids in the wheel path and/or between the wheel path are comparable to the voids in the passing lane.

Progressive Scale – Concrete disintegration that at first appears as surface scaling but gradually progresses deeper.

Pumping – Displacement and ejection of water and suspended fine particles at joints, cracks and edges.

Raveling – The progressive disintegration of aggregate particles, by dislodgement, from the surface downward or edges inward.

Resurfacing – Supplemental surface placed on existing pavement to improve surface conformation or increase strength.

Rigid base and Pavements – A term applied to that type of pavement that is constructed with Portland Cement Concrete. Those, which due to high bending resistance, distribute loads to foundations over comparatively large areas.

Rutting – The formation of longitudinal depressions by wheel tracking.

Scaling – The peeling away of the surface of Portland Cement Concrete.

Scratch or Wedge Course – A course, separate from the binder course, placed on the base to overcome deficiencies as lack of or too much crown, or to adjust grade or super-elevation.

Settlement – The reduction in elevation of short sections of pavement or structures.

Shoving – The displacement of bituminous pavement due to the action of traffic, generally resulting in bulging of the surface.

Shoulder – A portion of the roadbed between the traffic lane and the top of the ditch in cuts and the top of the slope in embankments.

Spalling – The breaking or chipping of rigid pavement at joints, cracks or edges, usually resulting in fragments with feather edges.

Stripping – The separation of asphalt from aggregate particles due to the presence of moisture in asphalt pavements.

Sub-base – Specified or select material, of a planned thickness, placed as a foundation for pavement.

Subgrade – The material in cuts, fills and fill foundations immediately below the first layer of sub-base, base or pavement.

Subsealing or Undersealing – The placing of waterproof material under existing pavement to prevent the vertical flow of water or suspended solids that fill the voids under pavement.

Surface Course – The top course of a pavement providing a surface resistant to traffic abrasion or imparting structural value to pavement.

Surface Scale – A peeling away of the surface mortar of Portland Cement Concrete exposing sound concrete, even though the scale extends into the mortar surrounding coarse aggregate.

Surface Texture – The surface character of pavement that depends on size, shape, arrangement and distribution of aggregates and cement or binder.

Thrust – The pressure exerted by a rigid pavement against other pavements or structures.

Warping – The deviation of pavement surface from its original shape caused by temperature and moisture differentials within the slab.

Warping Joints – A joint permitting then warping of pavement slabs when moisture and temperature differentials occur in pavement, i.e., longitudinal or transverse joints with bonded steel or tie bars passing through them.

5. CONCRETE TERMS

Admixtures – Materials other than cement, aggregate and water in concrete used or entrain air, retard setting or accelerate setting.

Anchorage – That portion of a reinforcing bar, and any attachment thereto, designed to resist pulling out or slipping of the bar when subjected to stress.

Bleeding – The natural separation of a liquid from a liquid-solid or semisolid mixture; for example, water from freshly poured concrete.

Consistency – The degree of solidity or fluidity of freshly mixed concrete and commonly described as slump.

Curing Period – A period provided to prevent the formation of surface cracks due to the rapid loss of water while the concrete is plastic and to ensure attainment of the specified strength.

Fineness Modulus – The fineness modulus (FM) is an index of the fineness of an aggregate – the higher the FM, the coarser the aggregate. FM is the summation of the cumulative percentages of the material retained on the standard sieves divided by 100.

Honeycomb – A surface or interior defect in a concrete mass characterized by the lack of mortar between the coarse aggregate particles.

Laitance – Weak material, consisting principally of lime, which is formed on the surface of concrete, especially when excess water is mixed with the cement.

Saturated Surface Dry – A term used to describe the condition of an aggregate in which the pores of all the particles are completely filled with water, but their surfaces are free from moisture.

Slump – A measure of concrete consistency.

Yield – The cubic feet of concrete produced per sack of cement.

6. ASPHALT TERMS

Asphalt Cement – Fluxed or un-fluxed asphalt especially prepared for use in making bituminous pavements.

Batch – The quantity of mix discharged from the mixer in one complete operation of the plant before additional materials are introduced.

Bleeding – The presence of an excessive amount of asphalt on the surface due to either to an excessive amount of prime or tack coats or excessive asphalt in the mix.

C-Factor – Determined by the change in viscosity of asphalt cement during the mixing process relative to that during the Thin-Film Oven test and is used to determine whether incomplete combustion of or contamination by burner fuel is causing or could cause asphalt concrete pavement tenderness.

Cutback Asphalt – Asphalt cement that has been rendered liquid by fluxing with a petroleum distillate. (includes: RCs – Rapid Curing; MCs – Medium Curing; SCs – Slow Curing.)

Emulsion – An emulsion of asphalt cement and water with a small quantity of an emulsifying agent.

Prime Coat – The initial application of low viscosity liquid asphalt to an absorbent base prior to placing asphalt concrete.

Tack Coat – A thin layer of bitumen, road tar, or emulsion laid on a road to enhance adhesion of the course above it.

7. ASPHALT MIX DESIGN TERMS

Volume Swell – The increase in volume of compacted aggregate, soil, sand, or a combination of aggregates passing the 10 mesh sieve (2.0 mm) and stabilized with bituminous material, when soaked in water for a standard length of time.

Acceptance Samples and Tests – These are samples taken and tests made to ascertain on a day-to-day basis whether the quality of the materials being incorporated or proposed for incorporation into the construction conform to the plans and specifications.

Air Voids – The total volume of the small pockets of air between the coated aggregate particles throughout a compacted paving mixture, expressed as a percent of the bulk volume of the compacted paving mixture.

Anti-Rutting Specification – Defined as a series of specifications to reduce rutting. It requires a minimum of 70% mechanical fracture on at least one face of the 4 mesh fraction of material, revised aggregate gradation specification to conform to maximum density gradation curve. It allows a 1.05 pay factor as an incentive to stay closer to maximum density line and maintain greater uniformity. The temperature of the mix upon discharge from all mixers including drum dryers is specified in the mix design memorandum. Also, a Quality Assurance Plan is required.

Coarse Aggregate Angularity – The percentage (by mass) of aggregates larger than 4 mesh (4.75 mm) with one or more fractured faces.

Final Record Samples and Tests – These samples and tests are taken at random from completed construction work or completed portions thereof. They are to provide an independent spot-check of the adequacy and the effectiveness of the results obtained in Acceptance sampling and testing and to supplement these test results.

Fine Aggregate Angularity – The percent air voids present in loosely compacted aggregates smaller than No. 8 mesh (2.36 mm).

Flat and Elongated Particles – The percentage (by mass) of coarse aggregates that have a maximum to minimum dimension ratio greater than 5.

Immersion Compression – A method for measuring the loss of cohesion resulting from the action of water on compacted bituminous mixtures containing penetration graded asphalts.

Independent Assurance Samples and Tests – These are samples taken and tests made to provide an independent spot check of the adequacy and effectiveness of the results obtained in Acceptance sampling and testing and to supplement these test results. The samples are split in the field either into two or three portions that are tested by the field, district, or area, and the Materials Bureau in the case of a three-way split. These test results are used to compare testing procedures between the three laboratories.

Marshall Method of Asphalt Mix Design – A method that uses the measurement of resistance to plastic flow of cylindrical specimens of bituminous paving mixtures loaded on the lateral surface by means of the Marshall apparatus to achieve the following characteristics; sufficient asphalt, sufficient mix stability, sufficient voids and sufficient workability.

Marshall Stability – The stability measured during loading in the Marshall apparatus and is used to determine whether the compacted bituminous mixture will satisfy the demands of traffic without distortion or displacement.

Marshall Flow – The lateral deformation of the specimen at the point of maximum stability during loading in the Marshall apparatus, measured in hundredths of an inch and recorded as a whole number (0.15 inches becomes 15).

Quality Assurance – Defined as a contractual method used to monitor the quality of material incorporated into Plant Mix Surfacing and Portland Cement Concrete Pavement, and in the case of Plant Mix Surfacing, the density of the finished pavement. This is achieved by random sampling and or testing of contractor produced materials that will be used to establish price adjustments on a statistical basis.

Sand Equivalent (Clay Content) – Clay content is the percentage of clay material contained in the aggregate fraction that is finer than a 4 mesh (4.75 mm) sieve.

Superpave™ – Superior Performing Asphalt Pavements incorporates performance-based, asphalt materials characterization with the design environmental conditions to improve performance by controlling rutting, low temperature cracking and fatigue cracking.

Void in the Mineral Aggregate (VMA) – The volume of intergranular void space between the aggregate particles of a compacted paving mixture that includes the air voids and the effective asphalt content, expressed as a percent of the total volume of the sample.

Voids Filled with Asphalt (VFA) – The percentage portion of the volume of intergranular void space between the aggregate particles that is occupied by the effective asphalt.

8. ACRONYMS

The following are some of the more common symbols used in highway construction:

AASHTO	American Association of State Highway and Transportation Officials
AC	Asphalt Cement
ASTM	American Society for Testing Materials
BST	Bituminous Surface Treatment
BTB	Bituminous Treated Base
CAPAC	Corrugated Aluminum Pipe Arch Culvert
CAPC	Corrugated Aluminum Pipe Culvert
CSPAC	Corrugated Steel Pipe Arch Culvert
CSPC	Corrugated Steel Pipe Culvert
CTB	Cement Treated Base
FHPM	Federal-aid Highway Program Manual
FM	Fineness Modulus
FR	Final Record
HMA	Hot Mix Asphalt
IA	Independent Assurance
LTB	Lime Treated Base
MT	Montana Test
PC	Portland Cement
PCCP	Portland Cement Concrete Pavement
PG	Performance Grade
PMB	Plant Mix Base
PMS	Plant Mix Surfacing
PSI	Pounds Per Square Inch
QA	Quality Assurance
RCPAC	Reinforced Concrete Pipe Arch Culvert
RCPC	Reinforced Concrete Pipe Culvert
RMS	Road Mix Surfacing
SC	Seal Coat
SG	Specific Gravity
SPPAC	Structural (Sectional) Plate Pipe Arch Culvert
SPPC	Structural (Sectional) Plate Pipe Culvert

**METHODS OF SAMPLING AND TESTING
MT 604-04
CONVERSION TABLES**

Water

7.5 gal. water	=	1 cu. ft.
1 cu. ft. water	=	62.4 lbs.
3785 cc water	=	1 gal.
8.32 lbs. Water @ 25°c	=	1 gal.
231 cu. in. water	=	1 gal.
1728 cu. in. water	=	1 cu. ft.

Volume Measurements

1 cu. in.	=	0.000579 cu. ft.
1 cu. ft.	=	1728 cu. in.
1 cu. yd.	=	27 cu. ft.
1 cu. meter	=	35.31445 cu. ft.
1 cu. centimeter	=	0.0000353 cu. ft.

Weight Measurements

1 oz.	=	28.35 grams	
1 lb.	=	453.59 grams	= 0.454 kilograms
1 oz.	=	0.0625 lbs.	
1 lb.	=	16 oz.	
1 kilogram	=	2.2 lb.	= 1000 grams

Length Measurements				Area			
1 in.	=	0.0833 ft.	=	2.54 cm.	Circle	=	3.1416 * R ²
1 yd.	=	3 ft.	=	36 in.	1 sq. mile	=	640 acres
1 rod	=	16.5 ft.	=	198 in.	1 acre	=	43560 sq. ft.
1 chain	=	66 ft.	=	792 in.	1 sq. yd.	=	9 sq. ft.
1 mile	=	5280 ft.	=	1760 yd.	1 sq. yd.	=	1296 sq. in.
1 cm	=	0.032808 ft.	=	0.3937 in.	1 sq. ft.	=	144 sq. in.

Estimated Equivalents

1 cu. ft. concrete	=	150 lbs.
1 cu. ft. clay, undisturbed	=	110 lbs. dry; 135 lbs. wet
1 cu. ft. sand	=	100 lbs. loose; 115 lbs. consolidated
1 cu. yd. compacted clay	=	3500 lbs. (wet weight)
1 cu. yd. compacted stabilized gravel	=	3800 lbs.

cu. yds. * 1.9 = tons compacted stabilized gravel
 1 mile * 1 ft. * 1 in. compacted stabilized gravel = 30.8 tons

Miscellaneous

<u>Multiply</u>	<u>by</u>	<u>To obtain</u>
ft. per second	0.68182	miles per hour
miles per hour	88	feet per min.
pounds of water per min.	0.016021	cu. ft. per min.
cu. ft. per min.	0.12468	gal. per second

METHODS OF SAMPLING AND TESTING
MT 605-04
SAMPLES AND CERTIFICATIONS
(Montana Method)

1 Scope

- 1.1 This procedure is intended as a general guide to assist in determining whether material designated for use on a highway project should be sampled or should be accepted on certification.

2 Referenced Documents

MT Materials Manual

MT 601 Materials Sampling, Testing and Acceptance Guide

3 Samples and Certifications

- 3.1 In general, every item used must be sampled and an acceptance received before it can be incorporated into the work unless acceptance can be made based on the manufacturer's certification, field tests, or field inspection reports.
- 3.2 All major items to be sampled and tested and most items that may be accepted on the manufacturer's certification or label are listed in alphabetical order in [MT 601](#) with instructions for sampling, testing, and acceptance.

4 Small Quantities

- 4.1 Projects requiring only small quantities of materials may not require sampling and testing of certain items such as surfacing aggregates for projects under 500 tons, plant mix aggregate for projects under 500 tons, etc. [MT 601](#) covers most of the commonly used items included in this small quantity category.

5 Optional Samples

- 5.1 Should there be any question relative to the quality or validity of a material or the Project Manager chooses to obtain more samples than the minimum required, he has the option to submit as many additional samples as may be necessary to insure that specification material is being used. All materials incorporated into the project, whether represented by actual samples or certification, are subject to final field inspection and acceptance by the project Manager.

6 Official Samples

- 6.1 Samples of material to be incorporated into the work must be either sampled by, or the sampling must be witnessed by, a representative of the engineer in order to be considered official samples.

7 Report Form

- 7.1 Most major materials to be tested have a report form designed for their exclusive use. It is of the utmost importance that these forms be completed as fully as possible.
- 7.2 All other materials not covered by a particular report form, whether represented by a sample or a certification, must be accompanied by a miscellaneous report form No. 45. It is equally important that this report be fully completed. This form should show the name of the product, quantity involved, name and address of the manufacturer and / or supplier, etc. In the case of an acceptance on the basis of a certification, a remark must be made that no sample is being submitted and the acceptance is being made on the basis of pre-test, manufacturer's certification or label, Division Laboratory report, etc.

METHODS OF SAMPLING AND TESTING
MT 606-04
PROCEDURE FOR SELECTING SAMPLING LOCATIONS
BY RANDOM SAMPLING TECHNIQUE

1 Scope

- 1.1 The following is a method of selecting sampling locations of various materials from roadways and trucks hauling asphalt mixture.

2 Definitions

- 2.1 *Lot* – a quantity of material that one desires to control. It may represent a day's production, a specified tonnage, a specified number of truckloads, a specified time period during production.
- 2.2 *Sample* – a segment of a lot chosen to represent the total lot. It may represent any number of sub-samples.
- 2.3 *Sub-sample* – a segment of a sample, taken from a unit of the lot, i.e., specified ton, a specified time, a specified truckload.
- 2.4 *Sample Unit* – a portion of sub-sample taken from a unit of a lot and combined with one or more other sample units to make up a sub-sample.

3 Selecting Sampling Locations from Roadways

- 3.1 Table X-1, pages 5 to 8, contains random numbers for the general sampling procedures. To use this table for selecting locations for collecting samples, the following steps are necessary:
- 3.1.1 Determine the number of sampling locations within a section by selecting the maximum average longitudinal distance desired between samples and dividing the length of the section by the maximum average longitudinal distance.
- 3.1.2 Select a column of random numbers in Table X-1 by placing 28 one inch square pieces of cardboard, numbered 1 thru 28, into a container, shaking them to get them thoroughly mixed, and drawing out one.
- 3.1.3 Go to the column of Random Numbers identified with the number drawn from the container. In sub-column A, locate all numbers equal to and less than the number of sampling locations desired.
- 3.1.4 Multiply the total length of the section by the decimal values in sub-column B, found opposite the numbers located in sub-column A. Add the results to the station number at the beginning of the section to obtain the station of the sampling location.
- 3.1.5 Multiply the total width of the pavement in the section by the decimal values found in sub-column C, opposite the numbers in sub-column A, to obtain the offset distance from the left edge of the pavement to the sampling location.

4 Example

- 4.1 Given: A completed plant mix surfacing project, 24 feet wide, 16,500 feet long, running from Station 100+00 to 265+00.
- 4.1.1 For sampling purposes it is desired to take one pavement core for each 2-lane mile. The number of sampling locations for this section, then are:

$$\frac{16,500}{5,280} = 3.1 = 3 \text{ locations}$$

4.1.2 The number 16 drawn from a container identifies this column of random numbers in Table X-1 to use.

4.1.3 The numbers selected from column 16 are:

<u>Col. A</u>	<u>Col. B</u>	<u>Col. C</u>
3	0.548	0.688
2	0.739	0.298
1	0.331	0.925

4.1.4 Station number of sampling location:

<u>Length of Section, Feet</u>	<u>X</u>	<u>Col. B</u>	=	<u>Distance from Beginning of Section, Feet</u>	+	<u>Station at Beginning of section</u>	=	<u>Station Number of Sampling Location</u>
16,500		0.548		9042		100+00		190+42
16,500		0.739		12190		100+00		221+90
26,500		0.331		546		100+00		105+46

4.1.5 Offset distance from left edge of pavement to sampling location, feet.

<u>Width of Pavement, Feet</u>	<u>X</u>	<u>Col. C</u>	=	<u>Offset Distance From Left Edge of Pavement to Sampling Location, Feet</u>
24		0.688		16.5
24		0.298		7.2
24		0.925		22.2

4.1.6 Sampling locations are:

<u>Station Number</u>	<u>Distance From Left Edge, Feet</u>
190+42	16.5
221+90	7.2
105+46	22.2

5 Selecting Sampling Locations in Trucks Hauling Asphalt Mixture

5.1 In this procedure, the following steps are necessary to select the sampling locations:

5.1.1 Select lot size--it can be time (hours), an average day's production (tons), a selected tonnage [example: 2,000 tons (1815 mg)] or a selected number of truckloads. (A lot size of a day's production is recommended for this procedure as being convenient and easy to randomize.)

5.1.2 Select the number of samples desired per lot. One sample per lot, made up of four sub-samples, is the minimum recommended.

5.1.3 Select the number of locations in each truckload from which sampling units of asphalt mixtures will be taken to combine into one sub-sample. Two sampling units per sub-sample are recommended.

5.1.4 Assign each truckload of mixture in the lot a number, beginning with 1 for the first truckload and number them successively to the highest number in the lot. Find the truckload numbers for sampling by the following procedure:

- 5.1.4.1 Place consecutively numbered [1 through _____ one-inch (25 mm)] square pieces of cardboard, equal to the number of truckloads in the lot, into a container (such as a bowl). Mix them thoroughly before each drawing.
- 5.1.4.2 Draw a number of cardboard squares from the container equal to the number of sub-samples desired for the lot. The numerals on the cardboard squares will be the truckloads to be sampled.
- 5.1.5 Choose for each sub-sample desired the location in the truckload for each of the sampling units. Use the following steps:
 - 5.1.5.1 Divide the truck beds into equal quadrants and number them 1 through 4 in any order desired.
 - 5.1.5.2 Place four consecutively numbered [1 through 4, one-inch (25 mm)] square pieces of cardboard into a container (such as a bowl). Mix them thoroughly before each drawing.
 - 5.1.5.3 Draw out an amount of cardboard squares equal to the number of sample units desired. The numerals on each square drawn represent the quadrants from which the sample will be taken. Replace the cardboard squares and repeat this step for each sample unit of each sub-sample to be taken.

Note – The principles involved may be applied to any other type of sampling of various materials which use the measurements of time, quantity, depth or other distinctive measurements of a construction phase. There are other random methods such as using a watch or deck of cards that are readily adaptable to obtaining roadway samples and they may be used provided the full benefit of obtaining random samples is accomplished.

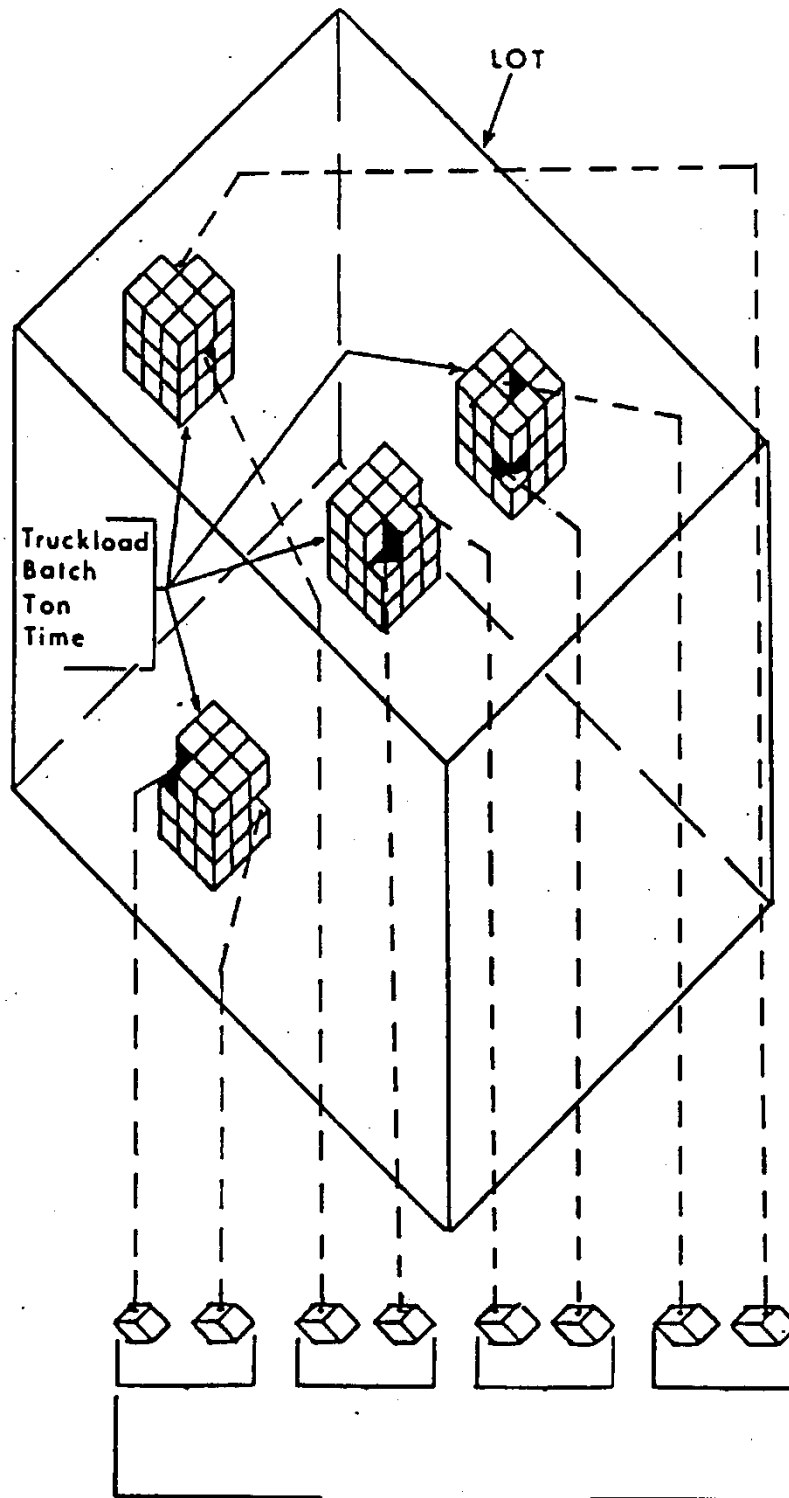

FIGURE 1—Schematic diagram illustrating *Lot, Sample, Subsample, and Sample Unit.*

TABLE X-1-RANDOM NUMBERS FOR GENERAL SAMPLING PROCEDURE

Col. No. 1			Col. No. 2			Col. No. 3			Col. No. 4			Col. No. 5			Col. No. 6			Col. No. 7		
A	B	C	A	B	C	A	B	C	A	B	C	A	B	C	A	B	C	A	B	C
15	.033	.576	05	.048	.879	21	.013	.220	18	.089	.716	17	.024	.863	30	.030	.901	12	.029	.386
21	.101	.300	17	.074	.156	30	.036	.853	10	.102	.330	24	.060	.032	21	.096	.198	18	.112	.284
23	.129	.916	18	.102	.191	10	.032	.746	14	.111	.925	26	.074	.639	10	.100	.161	20	.114	.848
30	.158	.434	06	.105	.257	25	.061	.954	28	.127	.840	07	.167	.512	29	.133	.388	03	.121	.656
24	.177	.397	28	.179	.447	29	.062	.507	24	.132	.371	28	.194	.776	24	.138	.062	13	.178	.640
11	.202	.271	26	.187	.844	18	.087	.887	19	.285	.899	03	.219	.166	20	.168	.564	22	.209	.421
16	.204	.012	04	.188	.482	24	.105	.849	01	.326	.037	29	.264	.284	22	.232	.953	16	.221	.311
08	.208	.418	02	.208	.577	07	.139	.159	30	.334	.938	11	.282	.262	14	.259	.217	29	.235	.356
19	.211	.798	03	.214	.402	01	.175	.641	22	.405	.295	14	.379	.994	01	.275	.195	28	.264	.941
29	.233	.070	07	.245	.080	23	.196	.873	05	.421	.282	13	.394	.405	06	.277	.475	11	.287	.199
07	.260	.073	15	.248	.821	26	.240	.981	13	.451	.212	06	.410	.157	02	.296	.497	02	.336	.992
17	.262	.308	29	.261	.087	14	.255	.374	02	.461	.023	15	.438	.700	26	.311	.144	15	.393	.488
25	.271	.180	30	.302	.883	06	.310	.043	06	.487	.539	22	.453	.635	05	.351	.141	19	.437	.655
06	.302	.672	21	.318	.088	11	.316	.653	08	.497	.396	21	.472	.824	17	.370	.811	24	.466	.773
01	.409	.406	11	.376	.936	13	.324	.585	25	.503	.893	05	.488	.118	09	.388	.484	14	.531	.014
13	.507	.693	14	.430	.814	12	.351	.275	15	.594	.603	01	.525	.222	04	.410	.073	09	.562	.678
02	.575	.654	27	.438	.676	20	.371	.535	27	.620	.894	12	.561	.980	25	.471	.530	06	.601	.675
18	.591	.318	08	.467	.205	08	.409	.495	21	.629	.841	08	.652	.508	13	.486	.779	10	.612	.859
20	.610	.821	09	.474	.138	16	.445	.740	17	.691	.583	18	.668	.271	15	.515	.867	26	.673	.112
12	.631	.597	10	.492	.474	03	.494	.929	09	.708	.689	30	.736	.634	23	.567	.798	23	.738	.770
27	.651	.281	13	.499	.892	27	.543	.387	07	.709	.012	02	.763	.253	11	.618	.502	21	.753	.614
04	.661	.953	19	.511	.520	17	.625	.171	11	.714	.049	23	.804	.140	28	.636	.148	30	.758	.851
22	.692	.089	23	.591	.770	02	.699	.073	23	.720	.695	25	.828	.425	27	.650	.741	27	.765	.563
05	.779	.346	20	.604	.730	19	.702	.934	03	.748	.413	10	.843	.677	16	.711	.508	07	.780	.534
09	.787	.173	24	.654	.330	22	.816	.802	20	.781	.603	16	.938	.849	19	.778	.812	04	.818	.187
10	.818	.837	12	.728	.523	04	.838	.166	26	.830	.384	04	.903	.327	07	.804	.675	17	.837	.353
14	.895	.631	16	.753	.344	15	.904	.116	04	.843	.002	09	.912	.382	08	.806	.952	05	.854	.818
26	.912	.376	01	.806	.134	28	.969	.742	12	.884	.582	27	.925	.162	18	.841	.414	01	.867	.133
28	.920	.163	22	.878	.884	09	.974	.046	29	.926	.700	20	.970	.582	12	.918	.114	08	.915	.538
03	.945	.140	25	.939	.162	05	.977	.494	16	.951	.601	19	.973	.327	03	.992	.399	25	.975	.584

(Continued) TABLE X-1-RANDOM NUMBERS FOR GENERAL SAMPLING PROCEDURE

Col. No. 8			Col. No. 9			Col. No. 10			Col. No. 11			Col. No. 12			Col. No. 13			Col. No. 14		
A	B	C	A	B	C	A	B	C	A	B	C	A	B	C	A	B	C	A	B	C
09	.042	.071	14	.061	.935	26	.038	.023	27	.074	.779	16	.073	.987	03	.033	.091	26	.003	.175
17	.141	.411	02	.065	.097	30	.066	.371	06	.084	.396	23	.078	.056	07	.047	.391	17	.089	.363
02	.143	.221	03	.094	.228	27	.073	.876	24	.098	.524	17	.096	.076	28	.064	.113	10	.149	.681
05	.162	.899	16	.122	.945	09	.095	.568	10	.133	.919	04	.153	.163	12	.066	.360	28	.238	.075
03	.285	.016	18	.158	.430	05	.180	.741	15	.187	.079	10	.254	.834	26	.076	.552	13	.244	.767
28	.291	.034	25	.193	.469	12	.200	.851	17	.227	.767	06	.284	.628	30	.087	.101	24	.262	.366
08	.369	.557	24	.224	.372	13	.259	.327	20	.236	.571	12	.305	.616	02	.127	.187	08	.264	.651
01	.436	.386	10	.225	.223	21	.264	.681	01	.245	.988	25	.319	.901	06	.144	.068	18	.285	.311
20	.450	.289	09	.233	.838	17	.283	.645	04	.317	.291	01	.320	.212	25	.202	.674	02	.340	.131
18	.455	.789	20	.290	.120	23	.363	.063	29	.350	.911	08	.416	.372	01	.247	.025	29	.353	.478
23	.488	.715	01	.297	.242	20	.364	.366	26	.380	.104	13	.432	.556	23	.253	.323	06	.359	.270
14	.496	.276	11	.337	.760	16	.395	.363	28	.423	.864	02	.489	.827	24	.320	.651	20	.387	.248
15	.503	.342	19	.389	.064	02	.423	.540	22	.487	.526	29	.503	.787	10	.328	.365	14	.392	.694
04	.515	.693	13	.411	.474	08	.432	.736	05	.552	.511	15	.518	.717	27	.338	.412	03	.408	.077
16	.532	.112	20	.447	.893	10	.476	.468	14	.564	.357	28	.524	.998	13	.356	.991	27	.440	.280
22	.557	.357	22	.478	.321	03	.508	.774	11	.572	.306	03	.542	.352	16	.401	.792	22	.461	.830
11	.559	.620	29	.481	.993	01	.601	.417	21	.594	.197	19	.585	.462	17	.423	.117	16	.527	.003
12	.650	.216	27	.562	.403	22	.687	.917	09	.607	.524	05	.695	.111	21	.481	.838	30	.531	.486
21	.672	.320	04	.566	.179	29	.697	.862	19	.650	.572	07	.733	.838	08	.560	.401	25	.678	.360
13	.709	.273	08	.603	.758	11	.701	.605	18	.664	.101	11	.744	.948	19	.564	.190	21	.735	.014
07	.745	.687	15	.632	.927	07	.728	.498	25	.674	.428	18	.793	.748	05	.571	.054	05	.797	.595
30	.780	.285	06	.707	.107	14	.745	.679	02	.697	.674	27	.802	.967	18	.587	.584	15	.801	.927
19	.845	.097	28	.737	.161	24	.819	.444	03	.767	.928	21	.826	.487	15	.604	.145	12	.836	.294
26	.846	.366	17	.846	.130	15	.840	.823	16	.809	.529	24	.835	.832	11	.641	.298	04	.854	.982
29	.861	.307	07	.874	.491	25	.863	.568	30	.838	.294	26	.855	.142	22	.672	.156	11	.884	.928
25	.906	.874	05	.880	.828	06	.878	.215	13	.845	.470	14	.861	.462	20	.674	.887	19	.886	.832
24	.919	.809	23	.931	.659	18	.930	.601	08	.855	.524	20	.874	.625	14	.752	.881	07	.929	.932
10	.952	.553	26	.960	.363	04	.934	.827	07	.867	.718	30	.929	.056	09	.774	.560	09	.932	.206
06	.961	.504	21	.978	.194	28	.963	.004	12	.881	.722	09	.935	.582	29	.921	.752	01	.970	.692
27	.969	.811	12	.982	.183	19	.998	.020	23	.937	.872	22	.947	.797	04	.959	.099	23	.973	.082

(Continued) TABLE X-1-RANDOM NUMBERS FOR GENERAL SAMPLING PROCEDURE

Col. No. 15			Col. No. 16			Col. No. 17			Col. No. 18			Col. No. 19			Col. No. 20			Col. No. 21		
A	B	C	A	B	C	A	B	C	A	B	C	A	B	C	A	B	C	A	B	C
15	.023	.979	19	.062	.588	13	.045	.004	25	.027	.290	12	.052	.075	20	.030	.881	01	.010	.946
11	.118	.465	25	.080	.218	18	.086	.878	06	.037	.571	30	.075	.493	12	.034	.291	10	.014	.939
07	.134	.172	09	.131	.295	26	.126	.990	26	.039	.026	28	.120	.341	22	.043	.893	09	.032	.346
01	.139	.230	18	.136	.381	12	.128	.661	07	.103	.176	27	.145	.689	28	.143	.073	04	.093	.180
16	.145	.122	05	.147	.864	30	.146	.337	18	.107	.358	02	.209	.957	03	.150	.937	15	.151	.012
20	.165	.520	12	.158	.365	05	.169	.470	22	.128	.827	26	.272	.818	04	.154	.867	16	.185	.455
06	.183	.481	28	.214	.184	21	.244	.433	23	.156	.440	22	.299	.317	19	.158	.339	07	.227	.277
09	.211	.316	14	.215	.757	23	.270	.849	15	.171	.157	18	.306	.475	29	.304	.615	02	.304	.400
14	.248	.348	13	.224	.846	25	.274	.407	08	.220	.097	20	.311	.653	06	.369	.633	30	.316	.074
25	.249	.890	15	.227	.809	10	.290	.925	20	.232	.066	15	.348	.156	18	.390	.536	18	.328	.799
13	.252	.577	11	.280	.898	01	.323	.490	04	.268	.576	16	.381	.710	17	.403	.392	20	.352	.288
30	.273	.088	01	.331	.925	24	.352	.291	14	.275	.302	01	.411	.607	23	.404	.182	26	.371	.216
18	.277	.689	10	.399	.992	15	.361	.155	11	.297	.589	13	.417	.715	01	.415	.457	19	.448	.754
22	.372	.938	30	.417	.787	29	.374	.882	01	.358	.305	21	.472	.484	07	.437	.696	13	.487	.598
10	.461	.075	08	.439	.921	08	.432	.139	09	.412	.089	04	.478	.885	24	.446	.546	12	.546	.640
28	.519	.536	20	.472	.484	04	.467	.266	16	.429	.834	25	.479	.080	26	.485	.768	24	.550	.038
17	.520	.090	24	.498	.712	22	.508	.880	10	.491	.203	11	.566	.104	15	.511	.313	03	.604	.780
03	.523	.519	04	.516	.396	27	.632	.191	28	.542	.306	10	.576	.659	10	.517	.290	22	.621	.930
26	.573	.502	03	.548	.688	16	.641	.836	12	.563	.091	29	.665	.397	30	.556	.853	21	.629	.154
19	.634	.206	23	.597	.508	19	.673	.629	02	.593	.321	19	.739	.398	25	.561	.837	11	.634	.908
24	.635	.810	21	.681	.114	14	.680	.890	30	.692	.198	14	.749	.759	09	.574	.599	05	.696	.459
21	.679	.841	02	.739	.298	28	.714	.508	19	.705	.445	08	.756	.919	13	.613	.762	23	.710	.078
27	.712	.366	29	.792	.038	06	.719	.441	24	.709	.717	07	.798	.183	11	.698	.783	29	.726	.585
05	.780	.497	22	.829	.324	09	.733	.040	13	.820	.739	23	.834	.647	14	.715	.179	17	.749	.916
23	.861	.106	17	.834	.647	17	.741	.906	05	.848	.866	06	.837	.978	16	.770	.128	04	.802	.186
12	.865	.377	16	.909	.608	11	.747	.205	27	.867	.633	03	.849	.964	08	.815	.385	14	.835	.319
29	.882	.635	06	.914	.420	20	.850	.047	03	.883	.333	24	.851	.109	05	.872	.490	08	.870	.546
08	.902	.020	27	.958	.856	02	.859	.356	17	.900	.443	05	.859	.935	21	.885	.999	28	.871	.539
04	.951	.482	26	.981	.976	07	.870	.612	21	.914	.483	17	.863	.220	02	.958	.177	25	.971	.369
02	.977	.172	07	.983	.624	03	.916	.463	29	.950	.753	09	.863	.147	27	.961	.980	27	.984	.252

(Continued) TABLE X-1-RANDOM NUMBERS FOR GENERAL SAMPLING PROCEDURE

Col. No. 22			Col. No. 23			Col. No. 24			Col. No. 25			Col. No. 26			Col. No. 27			Col. No. 28		
A	B	C	A	B	C	A	B	C	A	B	C	A	B	C	A	B	C	A	B	C
12	.031	.032	26	.031	.187	08	.015	.521	02	.039	.005	16	.026	.102	21	.050	.952	29	.042	.039
11	.048	.980	03	.053	.256	16	.068	.994	16	.061	.599	01	.033	.886	17	.085	.403	07	.105	.293
17	.089	.309	29	.100	.159	11	.118	.400	26	.068	.054	04	.088	.686	10	.141	.624	23	.115	.420
01	.091	.371	13	.102	.465	21	.124	.565	11	.073	.812	22	.090	.602	05	.154	.157	09	.126	.612
10	.100	.709	24	.110	.316	18	.153	.138	07	.123	.649	13	.114	.614	06	.164	.841	10	.205	.144
30	.121	.744	18	.114	.300	17	.190	.159	05	.126	.658	20	.136	.576	07	.197	.013	03	.210	.054
02	.166	.056	11	.123	.208	26	.192	.676	14	.161	.189	05	.138	.228	16	.215	.363	23	.234	.533
23	.179	.529	09	.138	.182	01	.237	.030	18	.166	.040	10	.216	.565	08	.222	.520	13	.266	.799
21	.187	.051	06	.194	.115	12	.283	.077	28	.248	.171	02	.233	.610	13	.269	.477	20	.305	.603
22	.205	.543	22	.234	.480	03	.286	.318	06	.255	.117	07	.278	.337	02	.288	.012	05	.372	.223
28	.230	.688	20	.274	.107	10	.317	.734	15	.261	.928	30	.405	.273	25	.333	.633	26	.385	.111
19	.243	.001	21	.331	.292	05	.337	.844	10	.301	.811	06	.421	.807	28	.348	.710	30	.422	.315
27	.267	.990	08	.346	.085	25	.441	.336	24	.363	.025	12	.426	.583	20	.362	.961	17	.453	.783
15	.283	.440	27	.382	.979	27	.469	.786	22	.378	.792	08	.471	.708	14	.511	.989	02	.460	.916
16	.352	.089	07	.387	.865	24	.473	.237	27	.379	.959	18	.473	.738	26	.540	.903	27	.461	.841
03	.377	.648	28	.411	.776	20	.475	.761	19	.420	.557	19	.510	.207	27	.587	.643	14	.483	.095
06	.397	.789	16	.444	.999	06	.557	.001	21	.467	.943	03	.512	.329	12	.603	.745	12	.507	.375
09	.409	.428	04	.515	.993	07	.610	.238	17	.494	.225	15	.640	.329	29	.619	.895	28	.509	.748
14	.465	.406	17	.518	.827	09	.617	.041	09	.620	.081	09	.645	.354	23	.623	.333	21	.583	.804
13	.499	.631	05	.539	.620	13	.641	.648	30	.623	.106	14	.680	.884	22	.624	.076	22	.587	.993
04	.539	.972	02	.623	.271	22	.664	.291	03	.625	.777	26	.703	.622	18	.670	.904	16	.689	.339
18	.560	.747	30	.637	.374	04	.668	.856	08	.631	.790	29	.739	.394	11	.711	.253	06	.727	.298
26	.575	.892	14	.714	.364	19	.717	.232	12	.715	.599	25	.759	.386	01	.790	.392	04	.731	.814
29	.756	.712	15	.730	.107	02	.776	.504	23	.782	.093	24	.803	.602	04	.813	.611	08	.807	.983
20	.760	.920	19	.771	.532	29	.777	.548	20	.810	.371	27	.842	.491	19	.843	.732	15	.833	.757
05	.847	.925	23	.780	.662	14	.823	.223	01	.841	.726	21	.870	.435	03	.844	.511	19	.896	.464
25	.872	.891	10	.924	.888	23	.848	.264	29	.862	.009	28	.906	.367	30	.858	.299	18	.916	.384
24	.874	.135	12	.929	.204	30	.892	.817	25	.891	.873	23	.948	.367	09	.929	.199	01	.948	.610
08	.911	.215	01	.937	.714	28	.943	.190	04	.917	.264	11	.956	.142	24	.931	.263	11	.976	.799
07	.946	.065	25	.974	.398	15	.975	.962	13	.958	.990	17	.993	.989	15	.939	.947	24	.978	.633

METHODS OF SAMPLING AND TESTING
MT 607-04
PROCEDURE FOR REDUCING FIELD SAMPLES
OF AGGREGATE TO TESTING SIZE
(Modified AASHTO R 76)

1 Scope

- 1.1 These methods cover the reduction of field samples of aggregate to the appropriate size for testing, and applies to fine aggregate (FA), coarse aggregate (CA), and mixes of the two, and employ techniques that are intended to minimize variations in measured characteristics between the test samples and the field sample.

Note 1 – Under certain circumstances, reduction in size of the field sample prior to testing is not recommended. Substantial differences between the selected test samples sometimes cannot be avoided, as for example, in the case of an aggregate having relatively few large size particles in the field sample. The laws of chance dictate that these few particles may be unequally distributed among the reduced size test samples. Similarly, if the test sample is being examined for certain contaminants occurring as a few discrete fragments in only small percentages, caution should be used in interpreting results from the reduced size test sample. Chance inclusion or exclusion of only one or two particles in the selected sample may importantly influence interpretation of the characteristics of the field sample. In these cases, the entire field sample should be tested.

2 Referenced Documents**AASHTO**

R 76 Reducing Samples of Aggregate to Testing Size

T 84 Specific Gravity and Absorption of Fine Aggregate

MT Materials Manual

MT 201 Sampling Roadway Materials

3 Selection of Method

- 3.1 *Fine Aggregates* – Field samples of fine aggregate (FA) that are drier than the saturated-surface-dry (SSD) condition (Note 2) shall be reduced to test size by a mechanical splitter according to Method A. Field samples of FA that are wetter than SSD may be reduced to test size by quartering according to Method B, or the entire field sample may be dried to drier than SSD, using temperatures that do not exceed those specified for any of the tests contemplated, and then reduced to test sample size using Method A.
- 3.1.1 Field samples of fine aggregate wetter than SSD may be reduced to testing size by treatment as a miniature stockpile as described in Method C.
- 3.1.2 If a moist field sample is very large, a preliminary split may be made by quartering according to Method B to reduce the sample to not less than 5000 g, the portion obtained is then dried and reduced to test sample size using Method A.
- 3.1.3 Mixtures of FA and CA that are wetter than SSD shall be reduced to test sample size according to Method B.

Note 2 – The method of determining the saturated-surface-dry condition is described in paragraph 7.2 of AASHTO T 84. As a quick approximation, if the fine aggregate will retain its shape when molded in the hand, it may be considered to be wetter than saturated-surface-dry.

- 3.2 *Coarse Aggregate* – Use of a mechanical splitter in accordance with Method A is preferred, however, the field sample may be reduced by quartering in accordance with Method B.

4 Field Sample Size

- 4.1 The size of the field sample shall conform to paragraph 3 of [MT 201](#).

METHOD A – MECHANICAL SPLITTER

5 Apparatus

5.1 *Sample Splitter* – Sample splitters shall have an even number of equal width chutes, but not less than a total of eight for coarse aggregate or twelve for fine aggregate which discharge alternately to each side of the splitter. The minimum width of the individual chutes shall be approximately 50 percent larger than the largest particles in the sample to be split (Table 1). The splitter shall be equipped with two receptacles to hold the two halves of the sample following splitting. It shall also be equipped with a hopper or straight-edged pan, which has a width equal to or slightly less than the overall width of the assembly of chutes by which the sample may be fed at a controlled rate to the chutes. The splitter and accessory equipment shall be so designed that the sample will flow smoothly without restriction or loss of material.

<u>Size Passing - 100%</u>	<u>Table 1</u>	<u>Splitter Opening</u>
2 in.		3 in. or 6 bars
1½ in.		2¼ in. or 6 bars
1 in.		1½ in. or 3 bars
¾ in.		1½ in. or 3 bars
½ in.		¾ in. or 2 bars
⅜ in.		9/16 in. or 2 bars
4M		½ in. or 1 bar

Each bar = ½ inch

Example – When splitting 1½ inch Crushed Base Course, the total sample would require 2¼ inches or 6 bars and the minus 4M would require ½ inch or 1 bar.

6 Procedure

6.1 Place the field sample in the hopper or pan and uniformly distribute it from edge to edge, so that when it is introduced into the chutes, approximately equal amounts will flow through each chute (Note 3). The rate at which the sample is introduced shall be such as to allow free flowing through the chutes into the receptacles below. Reintroduce the portion of the sample in one of the receptacles into the splitter as many times as necessary to reduce the sample to the size specified for the intended test. The portion of the material collected in the other receptacle may be reserved for reduction in size for other tests.

Note 3 – A sample splitter that has a hopper equipped with a dumping device may be filled and leveled with a straightedge prior to dumping into the chutes. A sample splitter that has a free-flowing hopper shall be filled by a container, which has a width equal to or slightly less than the overall width of the assembly of chutes. The side of the container shall be placed against the edge of the hopper and dumped in a single motion into the hopper. In no case shall the material be poured into the hopper from the end of the container, scoop, or shovel.

METHOD B – QUARTERING**7 Apparatus**

- 7.1 The apparatus shall consist of a straightedge, scoop, shovel, or trowel; a broom or brush; and a canvas blanket approximately 6 x 8 ft (2 x 2.5 m).

8 Procedure

- 8.1 Place the field sample on a hard, clean, level surface where there will be neither loss of material nor the accidental addition of foreign material. Mix the material thoroughly by turning the entire sample over three times. With the last turning, shovel the entire sample into a conical pile by depositing each shovelful on top of the preceding one. Carefully flatten the conical pile to a uniform thickness and diameter by pressing down the apex with a shovel so that each quarter sector of the resulting pile will contain the material originally in it. The diameter should be approximately four to eight times the thickness. Divide the flattened mass into four equal quarters with a shovel or trowel and remove two diagonally opposite quarters, including all fine material, and brush the cleared spaces clean. Successively mix and quarter the remaining material until the sample is reduced to the desired size.
- 8.2 As an alternate method when the floor surface is uneven, the field sample may be placed on a canvas blanket and mixed with a shovel as described above or by alternately lifting each corner of the canvas and pulling it over the sample toward the diagonally opposite corner causing the material to be rolled. Flatten the pile as described in paragraph 8.1. Divide the sample as also described in paragraph 8.1 or if the surface beneath the blanket is uneven, insert a stick or pipe beneath the blanket and under the center of the pile, then lift both ends of the stick dividing the sample into two equal parts. Remove the stick leaving a fold of the blanket between the divided portions. Insert the stick under the center of the pile at right angles to the first division and again lift both ends of the stick, dividing the sample into four equal parts. Remove two diagonally opposite quarters, being careful to clean the fines from the blanket. The remaining two quarters shall be successively remixed and quartered until the sample is reduced to the desired size.

METHOD C – MINIATURE STOCKPILE SAMPLING**9 Apparatus**

- 9.1 The apparatus shall consist of a small sampling thief, small scoop, or spoon.

10 Procedure

- 10.1 Place the field sample on a hard, clean, level, non-absorbent surface. Thoroughly mix the sample and form a miniature stockpile. Obtain a sample for each test by selecting at least five increments of material at random locations from the miniature stockpile, using any of the devices described in paragraph 9.

**METHODS OF SAMPLING AND TESTING
MT 608-04
VOIDS TABLE**

Percent Voids $\frac{SG \times 6.7.355 - wt.}{SG \times 62.3555} \times 100$

Voids shown to the nearest one-tenth (1/10)

S.G.	2.55	2.26	2.57	2.58	2.59	2.60	2.61	2.62	2.63	2.64	2.65	2.66	2.67	2.68	2.69	2.70
Wt/Ft ³																
90	43.4	43.6	43.9	44.1	44.3	44.5	44.7	44.9	45.1	45.3	45.5	45.7	45.9	46.1	46.3	46.5
91	42.8	43.0	43.2	43.4	43.6	43.9	44.1	44.3	44.5	44.7	44.9	45.1	45.3	45.5	45.7	45.9
92	42.1	42.4	42.6	42.8	43.0	43.2	43.5	43.7	43.9	44.1	44.3	44.5	44.7	44.9	45.1	45.4
93	41.6	41.7	42.0	42.2	42.4	42.6	42.9	43.1	43.3	43.6	43.7	43.9	44.1	44.3	44.5	44.8
94	40.9	41.1	41.3	41.6	41.8	42.0	42.2	42.5	42.7	42.9	43.1	43.3	43.5	43.7	44.0	44.2
95	40.2	40.5	40.7	40.9	41.2	41.4	41.6	41.8	42.1	42.3	42.5	42.7	42.9	43.1	43.4	43.6
96	39.6	39.9	40.1	40.3	40.6	40.8	41.0	41.2	41.5	41.7	41.9	42.1	42.3	42.5	42.8	43.0
97	39.0	39.2	39.5	39.7	39.9	40.2	40.4	40.6	40.8	41.1	41.3	41.5	41.7	42.0	42.2	42.4
98	38.4	38.6	38.8	39.1	39.3	39.5	39.8	40.0	40.2	40.5	40.7	40.9	41.1	41.4	41.6	41.8
99	37.7	38.0	38.2	38.5	38.7	38.9	39.2	39.4	39.6	39.9	40.1	40.3	40.5	40.8	41.0	41.2
100	37.1	37.4	37.6	37.8	38.1	38.3	38.6	38.8	39.0	39.2	39.5	39.7	39.9	40.2	40.4	40.6
101	36.5	36.7	37.0	37.2	37.5	37.7	37.9	38.2	38.4	38.6	38.9	39.1	39.3	39.6	39.8	40.0
102	35.8	36.1	36.3	36.6	36.8	37.1	37.3	37.6	37.8	38.0	38.3	38.5	38.7	39.0	39.2	39.4
103	35.2	35.5	35.7	36.0	36.2	36.5	36.7	36.9	37.2	37.4	37.7	37.9	38.1	38.4	38.6	38.8
104	34.6	34.8	35.1	35.3	35.6	35.8	36.1	36.3	36.6	36.8	37.1	37.3	37.5	37.8	38.0	38.2
105	34.0	34.2	34.5	34.7	35.0	35.2	35.5	35.7	36.0	36.2	36.5	36.7	36.9	37.2	37.4	37.6
106	33.3	33.6	33.8	34.1	34.4	34.6	34.9	35.1	35.4	35.6	35.8	36.1	36.3	36.6	36.8	37.0
107	32.7	33.0	33.2	33.5	33.7	34.0	34.2	34.5	34.8	35.0	35.2	35.5	35.7	36.0	36.2	36.4
108	32.1	32.3	32.6	32.9	33.1	33.4	33.6	33.9	34.1	34.4	34.6	34.9	35.1	35.4	35.6	35.8
109	31.4	31.7	32.0	32.2	32.6	32.8	33.0	33.3	33.5	33.8	34.0	34.3	34.5	34.8	35.0	35.3
110	30.8	31.1	31.4	31.6	31.9	32.1	32.4	32.7	32.9	33.2	33.4	33.7	33.9	34.2	34.4	34.7
111	30.2	30.5	30.7	31.0	31.3	31.5	31.8	32.1	32.3	32.6	32.8	33.1	33.3	33.6	33.8	34.1
112	29.6	29.8	30.1	30.4	30.6	30.9	31.2	31.4	31.7	32.0	32.2	32.5	32.7	33.0	33.2	33.5

$$\text{Percent Solids} = \frac{Wt / Ft^3}{SG \times 62.4} \times 100$$

METHODS OF SAMPLING AND TESTING
MT 609-16
FIELD NUMBERING CONCRETE CYLINDERS
(MONTANA METHOD)

1 Scope

- 1.1 The procedure outlined in this method has been adopted in order to establish a uniform, statewide numbering system for concrete test specimens and entry of specimens in MDT's SiteManager.

2 Terminology

2.1 Definitions

- 2.1.1 *Lot* – A single day's pour or every 200 yd³ (150 m³) of concrete poured, whichever is less, excluding Class Pave. A lot of Class Pave is a single day's pour or every 1,000 yd³ (750 m³) of concrete poured, whichever is less.

- 2.2.2 *Test* – A set of four (4) cylinders for Compressive Strength testing.

3 Specimen Number Procedure

- 3.1 Each concrete cylinder for an entire project will have its own unique specimen number.

- 3.2 Specimen numbers are to contain the Lot# (L), the Test# (T), and the Cylinder# in this format: L#T#_Cylinder# (e.g., L4T1_1, L4T1_2, etc). Cylinder numbers are to be in continuous consecutive order for each class of concrete for the entire project.

3.3 Example

- 3.3.1 Project A has a 24 yd³ pour on day 1. Cylinders from this pour would be Lot 1 and Specimen Numbers for day 1 would be L1T1_1-4.

- 3.3.2 Project A has a much larger pour on day 2. The first 200 yd³ poured would be Lot 2. Assuming 4 Tests in Lot 2, Lot 2 will have 16 cylinders. Specimen Numbers for Lot 2 would be L2T1_5-8, L2T2_9-12, L2T3_13-16, and L2T4_17-20.

Note 1 – A Cylinder# for Compressive Strength testing for a specific class of concrete should never be repeated. If 300 cylinders are cast for a specific class of concrete for a project, the cylinders should be numbered 1 through 300.

4 SiteManager Sample Record Procedure

- 4.1 Generate one (1) SiteManager Sample Record for each Lot of cylinders cast. The Sample Record can contain as many as four Tests (four (4) sets of four (4) cylinders) for Compressive Strength testing. A unique Sample Record is not required for each Test that is in the same Lot. Enter the following data to generate a Sample Record:

- a. Sample ID: Assigned by Site Manager
- b. Sample Date: The date the concrete was sampled in the field (not the logged date)
- c. Sample Type: Project Acceptance
- d. Acceptance Method: Test Results
- e. Material Code: Concrete Class Code (i.e., General, Pave, Pre, SCC, Deck, etc.)
- f. Witnessed by: Self explanatory
- g. Producer/Supplier: Supplier of the concrete (e.g., 99-FOSSUMR-SUPP for Fossum Ready Mix)
- h. QPL/PIT/MILL: Source of aggregate (e.g., 42-031010 for Fossum Ready Mix (Belzer) pit)

- i. Qualified Product Name: Leave blank
- j. District/Area: Self explanatory
- k. Contract Descr: Contract ID and Job Name
- l. Specimen Number(s): As described in Section 3 (e.g., L1T1-4_1-16)
- m. Intended Use: Describe use and location sample represents

Save Sample Record.

- 4.2 Navigate to the Add'l Sample Data tab. Enter data into Specimen Number(s) field, if blank. The Specimen Number(s) should match the Specimen Number(s) on the Basic Sample Data tab. Enter Control Type "Lot Number" then enter the Lot# in the Number box and Save.
- 4.3 Navigate to the Contract tab and attach appropriate Contract Number. Enter the Represented Quantity for the item associated with that sample (e.g. yd³ of concrete or yd² of sidewalk) and Save.
- 4.4 Navigate to the Tests tab. Attach a Concrete Properties test template for each sample tested for concrete properties in this Lot, whether or not it was tested with the cylinders. The Sample Test Number (Sample Test Nbr) should match the Test# entered in the Specimen Number box on the Basic Sample Data tab when applicable. Enter the Received Date, Actual Start Date, and Actual Completion Date in the fields displayed in the bottom right hand corner. These dates need to be filled in by the inspector for each test template attached and should be the same date as the Sample Date shown on the Basic Sample Data tab.

Note 2 – For each test template, ensure that the User ID of the personnel actually performing the testing is listed as the Tester.

5 Split Loads

- 5.1 On multiple structure jobs where one load of concrete is split and placed on more than one structure on the project, one set of test specimens will suffice, providing the split load of concrete is not altered in any way such as delaying successive pours, introducing additional water into the mix, etc.

6 Marking Sides of Cylinder

- 6.1 All identifying markings on concrete cylinders shall be placed on the sides of the cylinder instead of, or in addition to, markings being placed on the ends. Markings on the cylinders are to include at a minimum:
 - Full Sample ID assigned by SiteManager.
 - Specimen Number as described in Section 3.
 - Sample Date.

Note 3 – If necessary, concrete cylinders, upon arriving at the Materials Bureau, are immediately capped on both ends. If field personnel place the identifying numbers on the end of the cylinders only, it is necessary for the Materials Bureau to transfer the identifying numbers to the side of the cylinder before it is capped, as the original information will be covered by the caps. Transferring information increases the potential for errors.

METHODS OF SAMPLING AND TESTING
MT 610-04
METHOD OF NUMBERING SUBGRADE MATERIAL,
SURFACING MATERIAL, BITUMINOUS TREATED MATERIAL AND LIQUID ASPHALT
(Montana Method)

1 Scope

1.1 This method is intended to standardize the procedure in assigning field numbers to subgrade, surfacing, bituminous treated material and liquid asphalt.

2 Field Numbering Procedure

2.1 Sample numbers shall run consecutively throughout the project for each type and size of material. This must be repeated for each new source of material used on the project. Only one set of consecutive numbers is needed for contracts which involve two or more projects. All projects shall be listed, however, and the project for which the material is designated shall be indicated with a check mark.

3 Sub-grade Material

3.1 In the case of sub-grade, each type of material would mean original ground, embankment, pipe bedding, ramp, etc. Numbering shall be as outlined in paragraph 2.

4 Surfacing Material (Crushed Top Surfacing, Crushed Base Course, etc.)

4.1 Samples shall be numbered in accordance with paragraph 2.

5 Plant Mix Surfacing, Plant Mix Base, Road Mix Surfacing, Bituminous Surface Treatment and Bituminous Treated Base

5.1 In addition to samples of surfacing aggregates, samples of bituminous mixtures, as prepared for use in paving, shall be numbered as outlined in paragraph 2.

6 Liquid Asphalt

6.1 Samples shall be numbered in accordance with paragraph 2. When switching to a liquid asphalt produced by a different company or to a different grade of liquid asphalt, the numerical sequence must return to number one. Refer to MT 601 for sample size and frequency of sampling.

6.2 When sampling liquid asphalt, sample numbers and lot numbers will run consecutively. If the manufacturer changes and the grade remains the same, the sample numbers will start over but the lot numbers will continue. If the grade of asphalt changes, the sample number and lot number will both start over.

Example 1

Manufacturer	Grade		
MRC	PG 64-22	Sample No. 1 – 24	Lot No. 1 – 4
EXXON	PG 64-22	Sample No. 1 – 12	Lot No. 5 – 6
MRC	PG 64-28	Sample No. 1 – 18	Lot No. 1 – 3
MRC	PG 64-22	Sample No. 25 – 37	Lot No. 7 - 8

METHODS OF SAMPLING AND TESTING
MT 611-04
A GUIDE TO LABORATORY FORMS
(Montana Form Nos.)

1 Scope

- 1.1 This is a guide for the selection of the proper laboratory form when submitting samples, inspection reports, or certifications to the Materials Bureau.

2 General

- 2.1 The following listing is given in two parts. Part I is used when submitting materials for testing. Part II tells which forms to use when submitting inspection reports or certifications for various types of materials. Each of these parts is further broken down into different classes of material (aggregate, asphalt, steel, etc.). Following each individual item is the number of the laboratory form to be used.

PART I
FORMS TO ACCOMPANY SAMPLES

Soil and Aggregates

Bedding Material – MBA 123
 Blending Sand – MBA 123
 Blotter Material – MBA 123
 Binder – MBA 123
 Borrow – MBA 123
 Concrete Aggregate – MBA 124A
 Crushed Base Course – MBA 123
 Crushed Cover Aggregate – MBA 123
 Crushed Top Surfacing – MBA 123
 Cushion – MBA 123
 Filter Material – MBA 123
 Mineral Filler – MBA 123
 Plant Mix Base Course – MBA 123
 Plant Mix Surfacing – MBA 123
 Proposed Surfacing – MBA 123
 Proposed Concrete – MBA 124A
 Sand Surfacing – MBA 123
 Selected Surfacing – MBA 123
 Soil and Water for Corrosion – 45
 Soil for "R" Value – MBA 123
 Topsoil – MBA 123

Asphalt

All asphaltic materials will be submitted on the following laboratory forms;
 QA projects – CB-57
 Non QA projects and maintenance – 101-C

Bituminous Mixtures

Plant Mix Material for Extraction – 45
 Plant Mix Material for Monitoring – 45
 Plant Mix Pavement – 45

Steel Products

Reinforcing Bars – 45
 Pre-stress Strand – 45
 Wire Mesh – 45
 Steel Pipe – 45

Miscellaneous Materials

Bark – MBA 123
 Canvas Shims – 45
 Cement – 55
 Conduit – 45
 Delineators – 45
 Electrical Wire – 45
 Expansion Joint Filler – 45
 Fencing Items – 45
 Glass Beads – 45
 Mulch – 45
 Paint – 45
 Peat Moss – 45
 Plastic Pipe – 45
 Protective Coating – 45
 Riprap – 45
 Seed – 45
 Signing Material – 45
 U-posts – 45
 Wood Cores – 45
 Wood Preservatives – 45
 Wood Products – 45

Concrete Samples

Concrete Cores – 45
 Concrete Cylinders – 93
 Concrete Cylinders (AR) – 77
 Concrete Flexural Beams – 93

PART II
FORMS FOR INSPECTION AND CERTIFICATION

Certifications

Contractor's Certification of Compliance: Non-Structural Steel & Iron Items – Form 406
Contractor's Certification of Compliance: Miscellaneous Items – Form 407

All certifications of materials should be accompanied by Lab. Form No. 46

Inspection Reports

Corrugated Metal Pipe Culvert and Misc. Culvert Items – 102

Field Nuclear Density Tests – MBF 1000A

Pre-cast Concrete Items (Culverts, Barrier Rail, etc.) – 19A

Pre-stress Beam Inspection Report – 48

Pre-stress Beam Pre-tensioning Record – BR-12

Steel and Misc. Structural Materials

- 1) Fabrication Inspection – MB-2
- 2) Field Inspection – MBF 46

Welding Inspection

- 1) Pre-fabrication Welding – WI-1
- 2) Fabrication Welding – WI-2
- 3) Final Welding – WI-3
- 4) Miscellaneous Welding – WI-4

Wood Products – 45