

# ROCKER INTERCHANGE

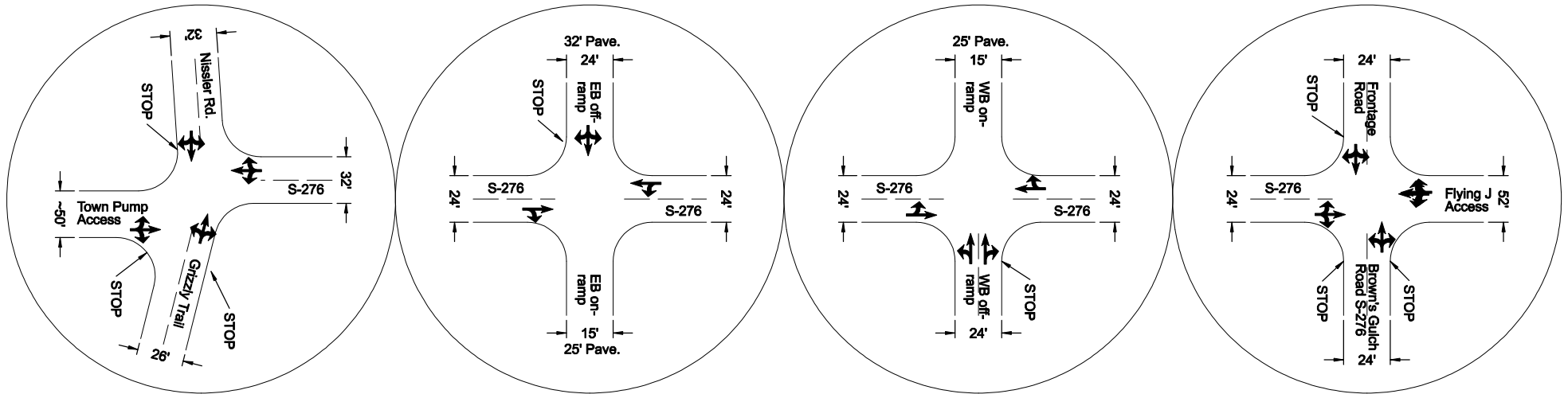

# I-115 & EXCELSIOR INTERCHANGE

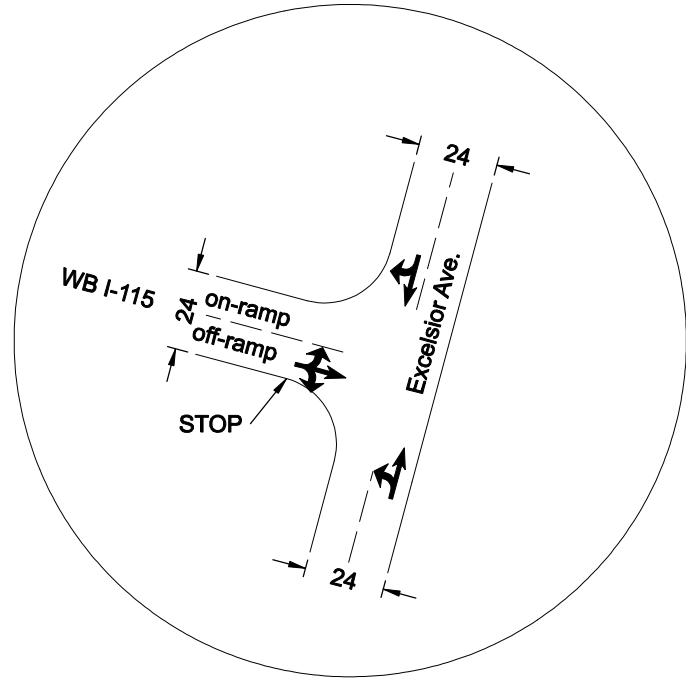
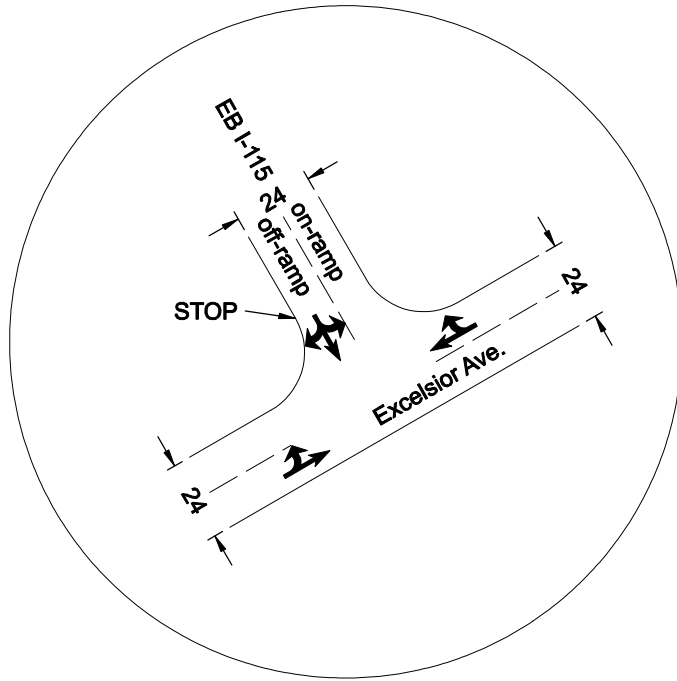

# IRON STREET (P-29)

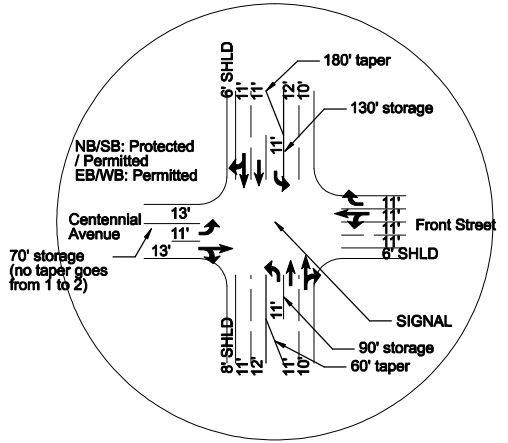
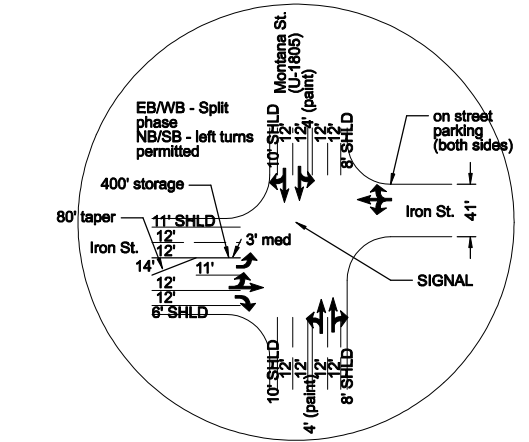
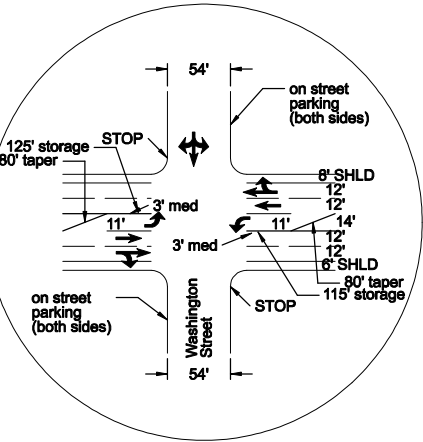
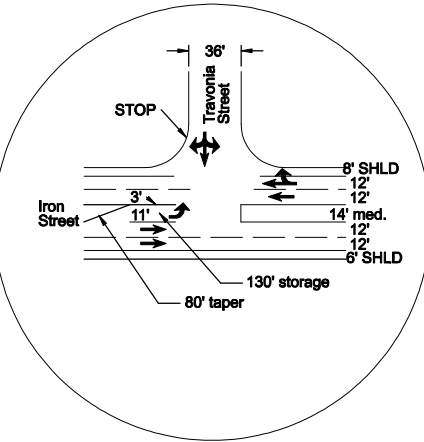
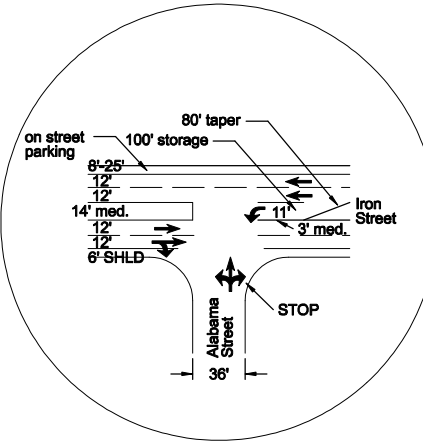

MONTANA STREET (U-1805)

# WB ramps

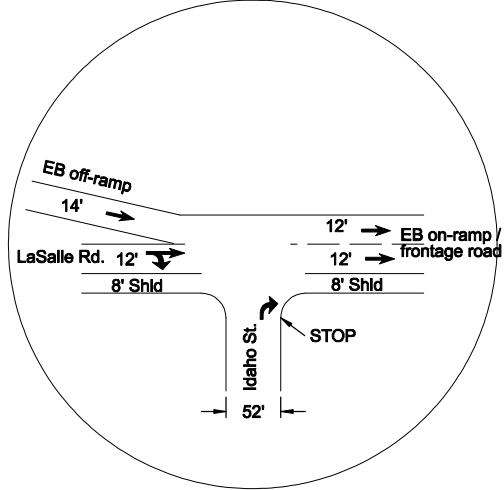
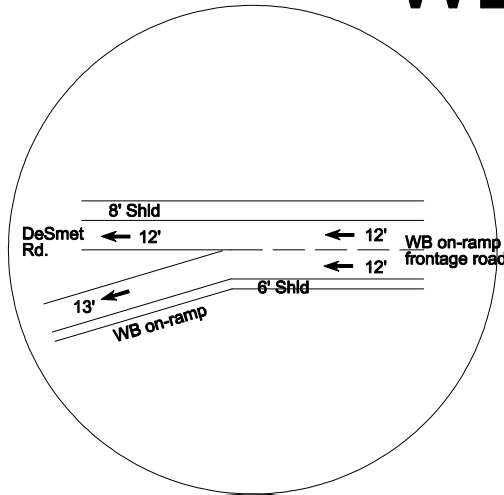

# Montana Street

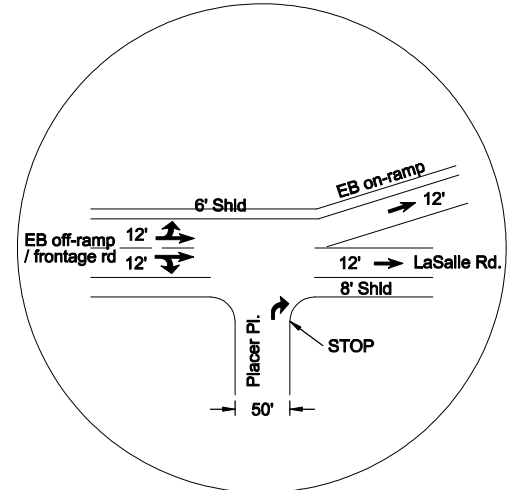
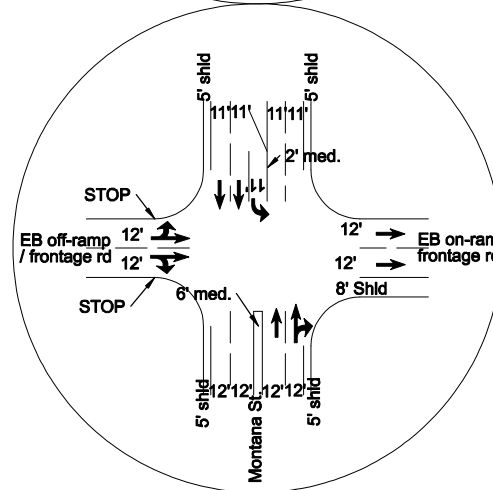
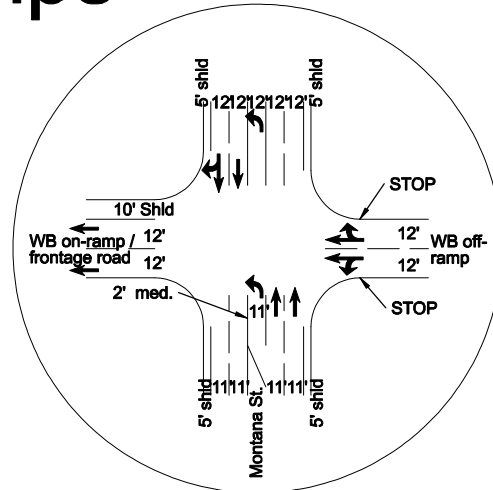

# EB ramps

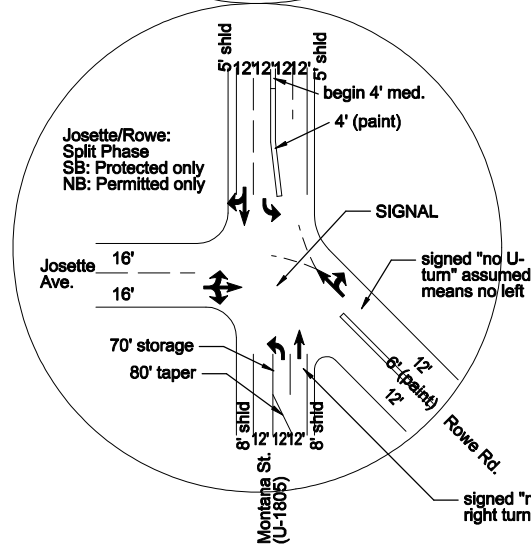

# HARRISON AVENUE

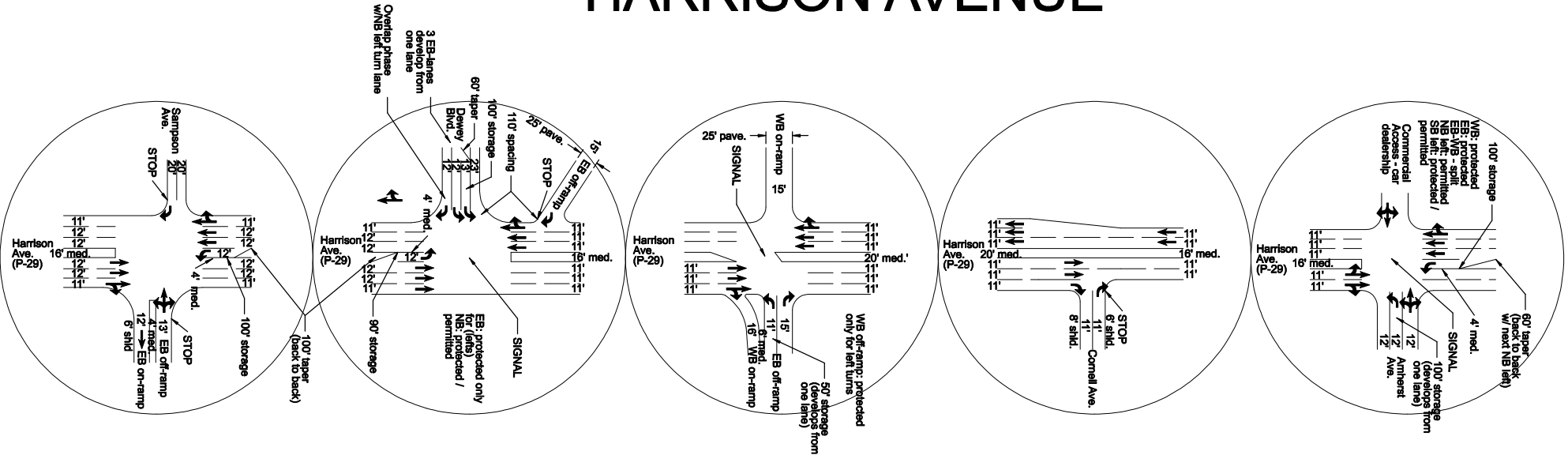

# CONTINENTAL DRIVE INTERCHANGE

